

Operating Instructions

Controller and display instrument for
level sensors

VEGAMET 625

Double channel HART



Document ID: 28970



VEGA

Contents

1	About this document	4
1.1	Function	4
1.2	Target group	4
1.3	Symbols used.....	4
2	For your safety	5
2.1	Authorised personnel	5
2.2	Appropriate use.....	5
2.3	Warning about incorrect use.....	5
2.4	General safety instructions	5
2.5	Installation and operation in the USA and Canada	6
2.6	Safety instructions for Ex areas	6
3	Product description	7
3.1	Configuration.....	7
3.2	Principle of operation.....	8
3.3	Adjustment.....	8
3.4	Packaging, transport and storage.....	9
4	Mounting	10
4.1	General instructions	10
4.2	Mounting instructions	10
5	Connecting to power supply	12
5.1	Preparing the connection	12
5.2	Sensor input mode active/passive.....	12
5.3	Connection procedure.....	13
5.4	Wiring plan	14
6	Setup with the integrated display and adjustment unit	16
6.1	Adjustment system	16
6.2	Setup steps	17
6.3	Menu schematic.....	28
7	Setup with PACTware	37
7.1	Connect the PC.....	37
7.2	Parameter adjustment with PACTware.....	39
7.3	Setup web server/e-mail, remote enquiry.....	40
8	Application examples	41
8.1	Level measurement in a horizontal cylindrical tank with overfill protection/dry run protection	41
8.2	Screen control in a hydroelectric power station	42
8.3	Interface measurement with VEGAFLEX.....	44
8.4	Pump control 1/2 (run time controlled).....	45
8.5	Tendency recognition	47
8.6	Flow measurement.....	49
9	Diagnostics and servicing	51
9.1	Maintenance	51
9.2	Rectify faults.....	51
9.3	Diagnosis, fault messages	51
9.4	How to proceed if a repair is necessary.....	53

10 Dismount.....	55
10.1 Dismounting steps.....	55
10.2 Disposal	55
11 Certificates and approvals.....	56
11.1 Approvals for Ex areas	56
11.2 Approvals as overfill protection.....	56
11.3 EU conformity.....	56
11.4 Environment management system	56
12 Supplement	57
12.1 Technical data	57
12.2 Overview applications/functionality	60
12.3 Dimensions	61
12.4 Industrial property rights.....	62
12.5 Trademark	62

1 About this document

1.1 Function

This instruction provides all the information you need for mounting, connection and setup as well as important instructions for maintenance, fault rectification, the exchange of parts and the safety of the user. Please read this information before putting the instrument into operation and keep this manual accessible in the immediate vicinity of the device.

1.2 Target group

This operating instructions manual is directed to trained personnel. The contents of this manual must be made available to the qualified personnel and implemented.

1.3 Symbols used



Document ID

This symbol on the front page of this instruction refers to the Document ID. By entering the Document ID on www.vega.com you will reach the document download.



Information, note, tip: This symbol indicates helpful additional information and tips for successful work.



Note: This symbol indicates notes to prevent failures, malfunctions, damage to devices or plants.



Caution: Non-observance of the information marked with this symbol may result in personal injury.



Warning: Non-observance of the information marked with this symbol may result in serious or fatal personal injury.



Danger: Non-observance of the information marked with this symbol results in serious or fatal personal injury.



Ex applications

This symbol indicates special instructions for Ex applications.



List

The dot set in front indicates a list with no implied sequence.



Sequence of actions

Numbers set in front indicate successive steps in a procedure.



Battery disposal

This symbol indicates special information about the disposal of batteries and accumulators.

2 For your safety

2.1 Authorised personnel

All operations described in this documentation must be carried out only by trained, qualified personnel authorised by the plant operator.

During work on and with the device, the required personal protective equipment must always be worn.

2.2 Appropriate use

VEGAMET 625 is a universal signal conditioning instrument and power supply unit for connection of two HART sensors.

You can find detailed information about the area of application in chapter " *Product description*".

Operational reliability is ensured only if the instrument is properly used according to the specifications in the operating instructions manual as well as possible supplementary instructions.

2.3 Warning about incorrect use

Inappropriate or incorrect use of this product can give rise to application-specific hazards, e.g. vessel overfill through incorrect mounting or adjustment. Damage to property and persons or environmental contamination can result. Also, the protective characteristics of the instrument can be impaired.

2.4 General safety instructions

This is a state-of-the-art instrument complying with all prevailing regulations and directives. The instrument must only be operated in a technically flawless and reliable condition. The operator is responsible for the trouble-free operation of the instrument. When measuring aggressive or corrosive media that can cause a dangerous situation if the instrument malfunctions, the operator has to implement suitable measures to make sure the instrument is functioning properly.

During the entire duration of use, the user is obliged to determine the compliance of the necessary occupational safety measures with the current valid rules and regulations and also take note of new regulations.

The safety instructions in this operating instructions manual, the national installation standards as well as the valid safety regulations and accident prevention rules must be observed by the user.

For safety and warranty reasons, any invasive work on the device beyond that described in the operating instructions manual may be carried out only by personnel authorised by the manufacturer. Arbitrary conversions or modifications are explicitly forbidden. For safety reasons, only the accessory specified by the manufacturer must be used.

To avoid any danger, the safety approval markings and safety tips on the device must also be observed.

2.5 Installation and operation in the USA and Canada

This information is only valid for USA and Canada. Hence the following text is only available in the English language.

Installations in the US shall comply with the relevant requirements of the National Electrical Code (ANSI/NFPA 70).

Installations in Canada shall comply with the relevant requirements of the Canadian Electrical Code.

2.6 Safety instructions for Ex areas

For applications in explosion-proof areas (Ex), only devices with corresponding Ex approval may be used. Observe the Ex-specific safety instructions. These are an integral part of the operating instructions and are enclosed with every device with Ex approval.

3 Product description

3.1 Configuration

Scope of delivery

The scope of delivery encompasses:

- Controller VEGAMET 625
- Terminal socket
- Coded pins and bridges
- RS232 modem connection cable (optional)
- Documentation
 - This operating instructions manual
 - Supplementary instruction 30325 "RS232/Ethernet connection" (optional)
 - Supplementary instructions manual 30768 "Modbus-TCP, VEGA ASCII protocol" (optional)
 - Ex-specific "Safety instructions" (with Ex versions)
 - If necessary, further certificates

Constituent parts

The VEGAMET 625 consists of the components:

- VEGAMET 625 controller with display and adjustment unit in the front
- Terminal socket

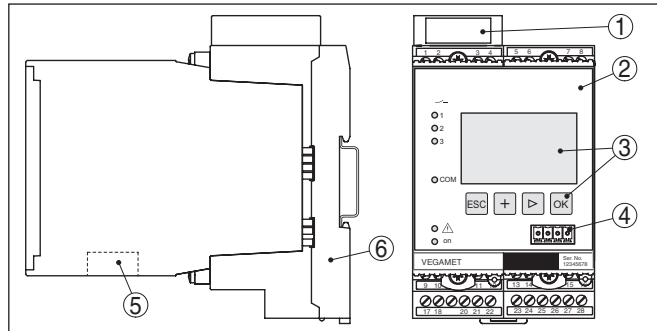

Fig. 1: VEGAMET 625

- 1 Ex separating chamber with Ex version
- 2 VEGAMET 625
- 3 Display and adjustment unit
- 4 Communication interface for VEGACONNECT (I²C)
- 5 RS232 or Ethernet interface (optional)
- 6 Terminal socket

Type label

The type label contains the most important data for identification and use of the instrument:

- Instrument type
- Information about approvals
- Technical data
- Serial number of the instrument
- QR code for device documentation
- Manufacturer information

Serial number

The type label contains the serial number of the instrument. With it you can find the following data on our homepage:

- Product code of the instrument (HTML)
- Delivery date (HTML)
- Order-specific instrument features (HTML)
- Operating instructions at the time of shipment (PDF)
- Safety instructions and certificates

Move to "www.vega.com" and enter in the search field the serial number of your instrument.

Alternatively, you can access the data via your smartphone:

- Download the VEGA Tools app from the "*Apple App Store*" or the "*Google Play Store*"
- Scan the DataMatrix code on the type label of the instrument or
- Enter the serial number manually in the app

3.2 Principle of operation**Application area**

VEGAMET 625 is a universal controller for a number of applications such as level, gauge, interface and process pressure measurement. At the same time, it can serve as power supply unit for connected sensors. VEGAMET 625 is designed for connection of two independent VEGA HART sensors. Hence two independent measurements can be carried out. By means of a third measurement loop, the difference between the two input values can be calculated.

On instruments with one of the optional interfaces (RS232/Ethernet), the measured values can be retrieved via modem or network and displayed by means of a web browser or VEGA Inventory System. It is also possible to send measured values and messages via e-mail. The use of VEGAMET 625 is particularly suitable for stocktaking, VMI (Vendor Managed Inventory) and remote enquiry.

Functional principle

The VEGAMET 625 controller can power two HART sensors and process their measured signals via the same cable. The measured value transmission is carried out via a digital bus system (HART Multidrop). The requested parameter is displayed and also sent to the integrated current outputs for further processing. Hence the measured signal can be transferred to a remote indication or a superordinate control system. Three level relays for control of pumps or other actuators are also integrated.

3.3 Adjustment

The instrument can be adjusted with the following adjustment media:

- With integrated display and adjustment unit
- an adjustment software according to FDT/DTM standard, e.g. PACTware and a Windows PC

The entered parameters are generally saved in VEGAMET 625, when used with PACTware and PC also optionally in the PC.



Information:

When using PACTware and the corresponding VEGA DTM, additional settings can be carried out which are not possible or only partly possible with the integrated display and adjustment unit. When using an adjustment software, you either need one of the integrated interfaces (RS232/Ethernet) or the interface converter VEGACONNECT.

Further instructions for setting up the web server and e-mail functions can be found in the online help of PACTware or the VEGAMET 625 DTMs as well as the operating instructions manual "RS232/Ethernet connection".

3.4 Packaging, transport and storage

Packaging

Your instrument was protected by packaging during transport. Its capacity to handle normal loads during transport is assured by a test based on ISO 4180.

The packaging of standard instruments consists of environment-friendly, recyclable cardboard. For special versions, PE foam or PE foil is also used. Dispose of the packaging material via specialised recycling companies.

Transport

Transport must be carried out in due consideration of the notes on the transport packaging. Nonobservance of these instructions can cause damage to the device.

Transport inspection

The delivery must be checked for completeness and possible transit damage immediately at receipt. Ascertained transit damage or concealed defects must be appropriately dealt with.

Storage

Up to the time of installation, the packages must be left closed and stored according to the orientation and storage markings on the outside.

Unless otherwise indicated, the packages must be stored only under the following conditions:

- Not in the open
- Dry and dust free
- Not exposed to corrosive media
- Protected against solar radiation
- Avoiding mechanical shock and vibration

Storage and transport temperature

- Storage and transport temperature see chapter " *Supplement - Technical data - Ambient conditions* "
- Relative humidity 20 ... 85 %

4 Mounting

4.1 General instructions

Installation possibilities

Each series 600 instrument consists of the actual controller as well as a plug-in socket for carrier rail mounting (top-hat rail 35 x 7.5 according to DIN EN 50022/60715). Because it has protection class IP30 or IP20, the instrument is intended to be used in switching cabinets.

Ambient conditions

The instrument is suitable for standard ambient conditions acc. to DIN/EN/IEC/ANSI/ISA/UL/CSA 61010-1.

Make sure that the degree of contamination specified in chapter "Technical data" meets the existing ambient conditions.

4.2 Mounting instructions

Mounting

The terminal socket is designed for carrier rail mounting. The operating voltage is connected to terminals 17 and 18. For neighbouring series 600 instruments, it is possible to continue connection L1 and N directly via the supplied bridges. A maximum of five instruments can be through-connected in this way.



Danger:

Looping through via bridges is only allowed for the operating voltage (sockets L1 and N). The bridges must never be used with single instruments, at the end of a row of instruments or with other sockets. If this rule is not heeded, there is a danger of coming into contact with the operating voltage or causing a short circuit.



A VEGAMET 625 in Ex version is an auxiliary, intrinsically safe instrument and may not be installed in explosion-endangered areas.

Before setup, the Ex separating chamber must be attached (as shown below) with Ex versions. Safe operation can be only ensured if the operating instructions manual and the EG type approval certificate are observed. VEGAMET 625 must not be opened.

Instrument coding

All controllers are provided with different gaps depending on type and version (mechanical coding).

The plug-in socket is provided with coded pins that can be inserted to prevent accidental interchanging of the various instrument types.



With a VEGAMET 625 in Ex version, the supplied coded pins (type coded pin and Ex coded pin) must be inserted by the user according to the below table.

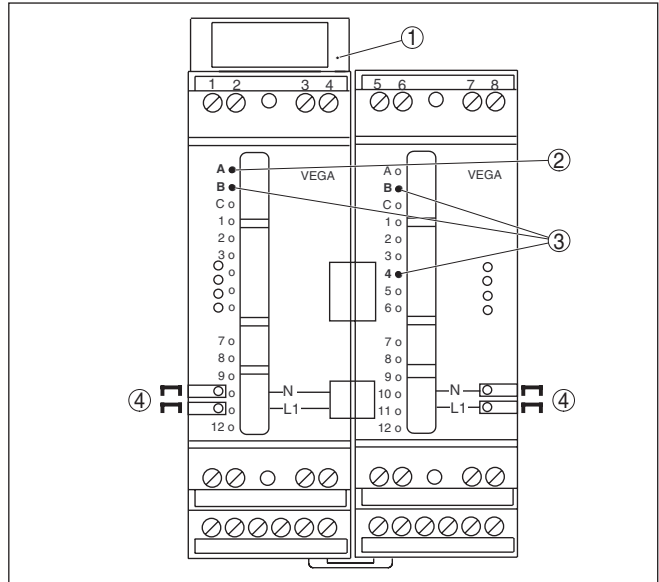

Fig. 2: Plug-in socket VEGAMET 625

- 1 Ex separating chamber
- 2 Ex coding with Ex version
- 3 Type coding for VEGAMET 624/625
- 4 Bridges for looping the operating voltage

5 Connecting to power supply

5.1 Preparing the connection

Safety instructions

Always keep in mind the following safety instructions:



Warning:

Connect only in the complete absence of line voltage.

- Connect only in the complete absence of line voltage
- If overvoltage surges are expected, overvoltage arresters should be installed



Note:

Install a disconnecting device for the instrument which is easy to access. The disconnecting device must be marked for the instrument (IEC/EN 61010).

Safety instructions for Ex applications



In hazardous areas you must take note of the respective regulations, conformity and type approval certificates of the sensors and power supply units.

Voltage supply

The data for power supply are specified in chapter " *Technical data*".

Connection cable

The voltage supply of VEGAMET 625 is connected with standard cable according to the national installation standards.

Standard two-wire cable can be used for connecting the sensors. The screening is absolutely necessary to ensure interference-free operation with HART sensors.

Make sure that the cable used has the required temperature resistance and fire safety for max. occurring ambient temperature

Cable screening and grounding

Connect the cable shielding on both ends to ground potential. In the sensor, the shielding must be connected directly to the internal ground terminal. The ground terminal on the outside of the sensor housing must be connected to the potential equalisation (low impedance).

If potential equalisation currents are expected, the screen connection on the side of VEGAMET 625 must be made via a ceramic capacitor (e. g. 1 nF, 1500 V). The low frequency potential equalisation currents are thus suppressed, but the protective effect against high frequency interference signals remains.

Connection cable for Ex applications



Take note of the corresponding installation regulations for Ex applications. In particular, make sure that no potential equalisation currents flow over the cable screen. In case of grounding on both sides this can be achieved by the use of a capacitor or a separate potential equalisation.

5.2 Sensor input mode active/passive

Through the selection of the terminals, you can choose between active and passive operation of the sensor input.

- In active mode, the controller provides the power for the connected sensors. Power and measurement data are transmitted over the same two-wire cable. This mode is provided for connection of measuring transducers without separate power supply (sensors in two-wire version).
- In passive mode the sensors are not powered, only the measured value is transmitted. This input is for connection of transmitters with their own separate voltage supply (sensors in four-wire version). The VEGAMET 625 can also be looped into the existing circuit like a normal ammeter.

**Note:**

With a VEGAMET 625 in Ex version, the passive input is not available.

5.3 Connection procedure

VEGAMET 625 is designed for connection of two HART sensors. Because they are accessed via different addresses in the HART multidrop mode, both sensors are connected to the same sensor input. These are either terminals 1/2 (active input) or terminals 3/4 (passive input). Simultaneous mixed operation on active and passive input is not possible. The measured value transmission is carried out via the digital HART signal. An analogue 4 ... 20 mA transmission is not possible.

Because this is a digital bus system, only one two-wire cable should lead to the two sensors. A distributor can be connected directly in front of the sensors. As an alternative, the connection to the next sensor can be continued via the second cable entry in the sensor housing. Before connection, the addressing the sensors should be carried out, see chapter "Setup".

**Note:**

Before the actual setup, each HART sensors must be assigned an address (address range 1-15), (see chapter "Setup"). Address 0 (mode 4 ... 20 mA) must not be used. When assigning an address, only one sensor should be connected to VEGAMET 625. If connection is completed already, the wiring must be briefly cancelled for addressing. Depending on the installation location of the sensors, it can be advantageous to carry out this addressing before installing and connecting the sensors. This can be conveniently carried out e.g. in the workshop. You just need a 24 Volt power supply as well as an indicating and adjustment module PLICSCOM or the adjustment software PACTware with VEGACONNECT.

Move on to electrical connection and proceed as follows:

1. Snap the socket without VEGAMET 625 onto the carrier rail
2. Connect sensor cable to terminal 1/2 (active input) or 3/4 (passive input), provide a screening
3. When using several sockets, loop the power supply by means of bridges
4. Connect power supply (switched off) to terminal 17 and 18
5. If necessary, connect relays or other outputs

- Insert VEGAMET 625 into the plug-in socket and screw it down tightly

**Note:**

If the addressing of the sensors has not yet been carried out, only one sensor must be connected. Addressing (see chapter "Setup") of the first sensor can then be carried out. Afterwards, the first sensor must be disconnected again and the next sensor connected and provided with an address. Then all sensors can be connected and setup can be started.



Before setting up Ex versions, make sure the Ex separating chamber is plugged on the left housing side (above the sensor terminals). The pins for type and Ex coding must also be inserted correctly.

5.4 Wiring plan

Wiring plan for two-wire sensors

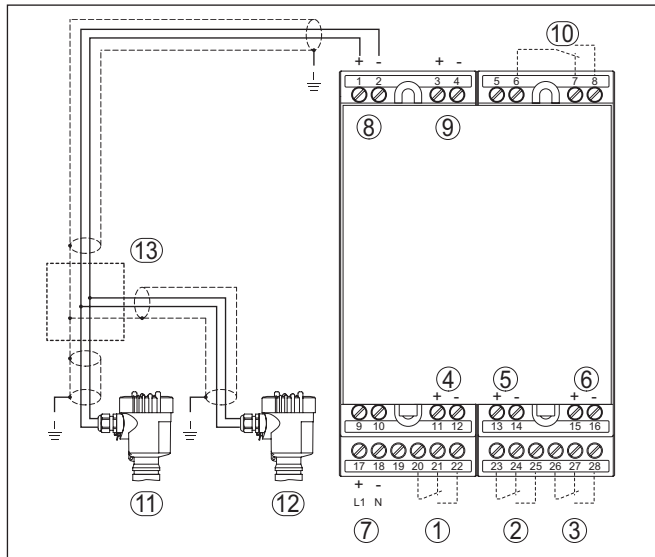

Fig. 3: Wiring plan VEGAMET 625 with two-wire sensors

- Internal operating relay 1
- Internal operating relay 2
- Internal operating relay 3
- Internal current output 1
- Internal current output 2
- Internal current output 3
- Voltage supply of VEGAMET 625
- Measurement data input with sensor supply (active input)
- Measurement data input (passive input), not in Ex ia
- Internal fail safe relay
- HART two-wire sensor with Multidrop address 1
- HART two-wire sensor with Multidrop address 2
- Distributor

Wiring plan for four-wire sensors

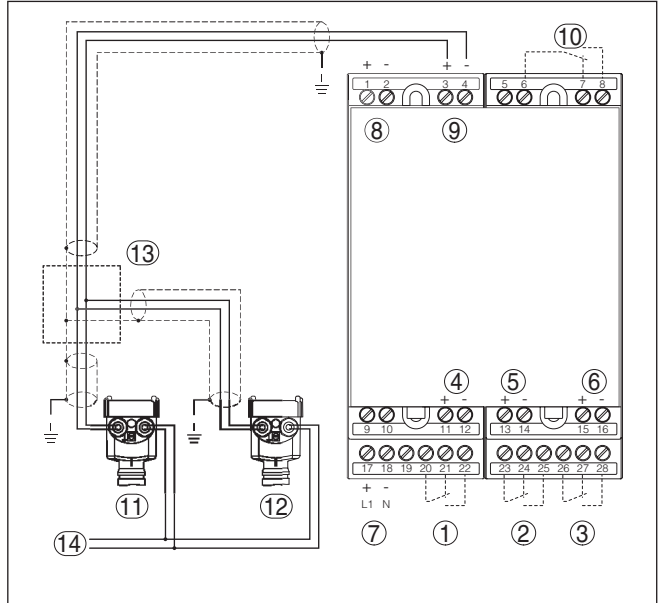

Fig. 4: Wiring plan VEGAMET 625 with four-wire sensors

- 1 Internal operating relay 1
- 2 Internal operating relay 2
- 3 Internal operating relay 3
- 4 Internal current output 1
- 5 Internal current output 2
- 6 Internal current output 3
- 7 Voltage supply of VEGAMET 625
- 8 Measurement data input with sensor supply (active input)
- 9 Measurement data input (passive input), not in Ex ia
- 10 Internal fail safe relay
- 11 HART four-wire sensor with Multidrop address 1
- 12 HART four-wire sensor with Multidrop address 2
- 13 Distributor
- 14 Power supply for four-wire sensors

6 Setup with the integrated display and adjustment unit

6.1 Adjustment system

Function

The integrated display and adjustment unit is used for measured value display, adjustment and diagnosis of VEGAMET 625 as well as the connected sensors. The indication and adjustment are carried out via four keys and a clear, graphic-capable display with background lighting. The adjustment menu with selectable language is clearly structured and enables easy setup.

Certain adjustment options are not possible or only partially available with the integrated display and adjustment unit, e.g. settings for the e-mail server. For such applications, the use of PACTware with appropriate DTMs is recommended.

Display and adjustment elements

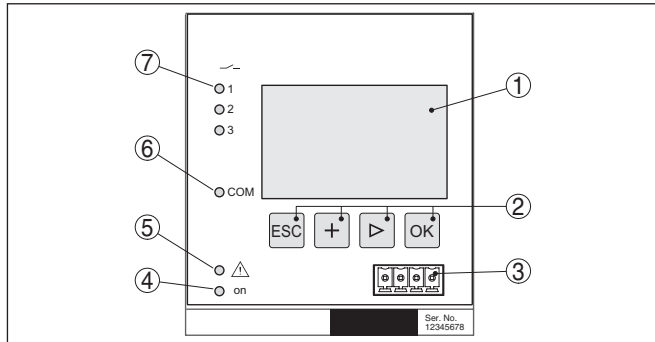

Fig. 5: Display and adjustment elements

- 1 LC display
- 2 Adjustment keys
- 3 Communication interface for VEGACONNECT
- 4 Status indication operation
- 5 Status indication fail safe relay
- 6 Status indication interface activity
- 7 Status indication operating relay 1 - 3

Key functions

Key	Function
[OK]	Entry to the menu level Jump to selected menu item Edit parameter Save value
[>]	Switching between the individual measured value indications Navigation in the menu items Select editing position
[+]	Change parameter values

Key	Function
[ESC]	Jump to next higher menu Interrupt input

6.2 Setup steps

Parameter adjustment

Through parameter adjustment, the instrument is adapted to the individual application conditions. A measurement loop calibration is the most important step and should always be carried out. A scaling of the measured value to the desired physical variable and unit, possibly including a linearisation curve, is often useful. The adaptation of the relay switching points or the setting of an integration time to smooth the measured value are further standard adjustment options.

Instruments with Ethernet interface can be provided with a Host name suitable for the measurement loop. As an alternative to the addressing via DHCP, it is also possible to adjust an IP address and subnet mask suitable for your network. If necessary, the e-mail/Web server can be also configured with PACTware.



Information:

When using PACTware and the corresponding VEGA DTM, additional settings can be carried out which are not possible or only partly possible with the integrated display and adjustment unit. When using an adjustment software, you either need one of the integrated interfaces (RS232/Ethernet) or the interface converter VEGACONNECT.

Further instructions for setting up the web server and e-mail functions are stated in the online help of PACTware or the VEGAMET 625 DTMs as well as the supplementary instructions manual "*RS232/Ethernet connection*".

Set HART address

VEGAMET 625 can process measured values of more than one HART sensor. The measured values are transmitted as digital HART signals to the same cable (bus). An analogue 4 ... 20 mA transmission is not possible, the current is limited to 4 mA. An own, unambiguous address (address range 1-15) must be assigned to each connected sensor. This mode is also called HART multidrop mode. Address 0 (mode 4 ... 20 mA) must not be used.



Note:

When addresses are being assigned, only one sensor must be connected on the bus. If this is not the case, no sensor can be accessed and it is not possible to assign an address.

The addressing can be carried out directly on each HART sensor via the respective adjustment unit or adjustment software. As an alternative, the setting of the sensor address can be also carried out via the VEGAMET menu under "*Service - Sensor address*" (see chapter "*Setup procedure*" under "*Service - Change sensor address*").



Switch-on phase

After being switched on, VEGAMET 625 first of all carries out a short self-check. The following steps are carried out:

- Internal check of the electronics
- indication of the instrument type, firmware version as well as the instrument TAG (instrument name)
- The output signals jump briefly to the set fault value

After the assignment of the addresses to the sensors, the current measured values will be displayed and output.

Measured value indication

As requested, the measured value display shows the individual measurement loops separately or in a joint overview. The respective digital display value, the measurement loop name (meas. loop TAG) and the unit are shown. With the separate presentation, an analogue bar graph is also displayed and the measured values appear in bigger font size. By pushing the **[>]** key, you move between the different indicating options.

**Note:**

Depending on the configuration and use of all measurement loops, the cycle time for the measured value transmission can take up to five seconds.

TAG-No. 1	91.8	%	TAG-No. 1	91.8	%	
TAG-No. 2	67.5	%	TAG-No. 2	67.5	%	
TAG-No. 3	24.3	%	TAG-No. 3		%	

By pushing **[OK]** you move from the measured value indication to the main menu.

Main menu

The main menu is divided into six areas with the following functions:

- **Device settings:** Includes the device-TAG, settings for network connection such as date/time setting, ...
- **Measurement loop:** Includes settings for input selection, adjustment, damping, linearisation, scaling, outputs, ...
- **Display:** Includes settings to the displayed measured value
- **Diagnosis** Includes information on device status, error messages
- **Service** Includes simulation, reset, PIN, selectable language, sensor address, ...
- **Info:** Shows serial number, software version, last change, instrument features, MAC addr., ...



→ Select the menu item " *Device settings*" with **[>]** and confirm with **[OK]**.

Device settings - Application

Under the menu item " *Device settings*", you can select the requested application. For all level, gauge and differential measurements, the application " *Standard*" is correct.

If an interface measurement is to be carried out with a VEGAFLEX 67, you have to choose the menu item " *Interface measurement*" as application. After the configuration of the inputs, the exact dielectric constant for the upper medium must be entered. For further information see chapter " *Application examples*".

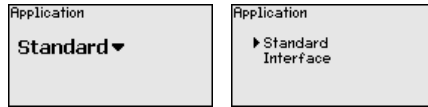

→ Select the requested application with **[->]** and save your setting with **[OK]**. Then go to menu item " *Input*" with **[->]**.

Device settings - Input

Because VEGAMET 625 has two inputs, the measurement loops must be assigned to the inputs. After the addresses of the HART sensors are assigned, a list of the existing sensors can be prepared and displayed via " *Sensor selection - Sensor search*". Now you can assign the requested sensor to each measurement loop.

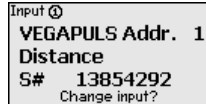

For transmission, VEGAMET 625 must be informed which " *Sensor value*" should be used for further processing. Depending on the sensor type this can be distance, pressure, interface or temperature. You will find further information under the menu item " *Meas. loop - Input*".

→ Allocate the requested inputs to the appropriate measurement loops, select the suitable sensor value and save your settings with **[OK]**. After the first setup, you can modify the inputs also under " *Meas. loop - Input*".

Device settings - Device-TAG

You can assign an unambiguous name to VEGAMET 625 via the Device-TAG. This function is recommended when several instruments are implemented and a good documentation of larger systems is required.

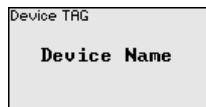

→ Enter the requested values via the appropriate keys and save your settings with **[OK]**.

Device settings - Host Name/IP addr.

For instruments with integrated Ethernet interface, the automatic addressing via DHCP is preset, i.e. the IP address must be assigned by a DHCP server. Generally the instrument is contacted via the Host name. By default, the host name consists of the serial number plus " *VEGA-*" in front. As an alternative, it is also possible to enter a static IP addr. with Subnet mask and optional Gateway addr.



Note:

Keep in mind that your modification will be only effective after a restart of VEGAMET 625. You can find further information of these network

parameters in the supplementary instructions "*RS232/Ethernet connection*" and in the Online help of the respective DTM.

Host name VEGA-14179608	IP address DHCP ▶ Fixed IP address	IP address Fixed IP address ▼	LAN/Internet IP address 192.168.200.200 Subnetmask 255.255.255.000 Change?
-----------------------------------	--	---	---

→ Carry out your settings via the appropriate keys and save with **[OK]**. Disconnect briefly the operating voltage so that the modified settings become effective.

Device settings - Time/Date

Date and time can be entered in this menu item for instruments with integrated RS232/Ethernet interface. These time settings are buffered in case of power failure for approx. 3 days.

Time/Date 13:51 27.11.2009
--

→ Enter the values via the appropriate keys and save your settings with **[OK]**.

Device settings - Communication protocol

For instruments with integrated RS232 interface, you determine here which mode this serial interface should operate in. The following options are available:

- **VVO protocol:** Direct standard connection between controller and PC for parameter adjustment and enquiry (e.g. with PACTware and DTM)
- **PPP:** Dial-up connection between controller and modem for independent transmission of e-mails (dial-out connection) or enquiry via web browser (dial-in connection)
- **ASCII protocol:** Direct standard connection between controller and PC for enquiry with terminal programs, e.g. Hyperterminal

Communication protokol VVO protocol ▼	Communication protokol ▶ VVO protocol ASCII protocol PPP
---	---

→ Carry out your settings via the respective keys and save with **[OK]**. Further information is available in the supplementary instructions manual "*RS232/Ethernet connection*" and the online help of the respective DTM.

Measurement loop - Input

Because VEGAMET 625 has two inputs, the measurement loops must be assigned to the inputs. After the addresses of the HART sensors are assigned, a list of the existing sensors can be prepared and displayed via the sensor search. Now you can assign the requested sensor to each measurement loop.

For transmission, VEGAMET 625 must be informed which "Sensor value" should be used for further processing. Depending on the sensor type this can be distance, pressure, interface or temperature. When HART sensors of other manufacturers are connected, the options PV (Primary Value) and SV (Secondary Value) will be available. Prerequisite is that the HART commands 0, 1, 3 and 15 are supported. This information and which measured values should be transmitted is stated in the operating instructions manual of the respective sensor manufacturer.



Meas. loop - Parameter

The measured variable defines the application of the measurement loop, the following settings are available depending on the connected sensor:

- Level
- Process pressure
- Temperature
- Difference (only with measurement loop 3)
- Interface
- Universal (for sensors of other manufacturers)

The third measurement loop is always a differential measurement loop calculating the difference of the values of measurement loops 1 and 2 (optionally measurement loop 1-2 or 2-1).



Information:

Keep in mind that some settings must be carried out individually several times, because they are specifically required for each measurement loop.

Meas. loop - Adjustment

Through the adjustment the input value of the connected sensor is converted into a percentage value. This conversion step allows any input value range to be depicted in a relative range (0 % up to 100 %).

Before carrying out the adjustment, the requested adjustment unit can be selected which depends on the sensor type. With radar, ultrasonic and guided microwave this is always the distance in metres or feet "m(d)" or "ft(d)", and with pressure transmitters it is e.g. "bar" or "psi".

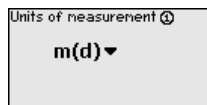

The following illustrations and examples relate to the min./max. adjustment of a radar sensor with HART communication.

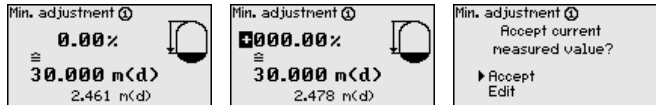

- With **[OK]** you prepare the percentage value for editing, with **[->]** you place the cursor to the requested position. Set the requested percentage value with **[+]** and save with **[OK]**.
- After entering the percentage value for the min. adjustment, the suitable distance value must be entered. If you want to use the currently measured distance value, select the menu item "Accept" (live adjustment or adjustment with medium). If the adjustment should be carried out independent of the measured level, then select the option "Edit". Enter now the distance value in m [m(d)] for the empty vessel that is suitable for the percentage value, e.g. distance from the sensor to the vessel bottom (dry adjustment or adjustment without medium).
- Save your settings with **[OK]** and move to "Max. adjustment" with **[->]**.

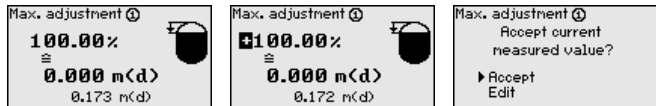

- As described previously, enter now the percentage value for max. adjustment and confirm with **[OK]**.
- After entering the percentage value for the max. adjustment, the suitable distance value must be entered. If you want to use the currently measured distance value, select the menu item "Accept" (live adjustment or adjustment with medium). If the adjustment should be carried out independent of the measured level, then select the option "Edit". Enter now the distance value in m [m(d)] for the full vessel that is suitable for the percentage value (dry adjustment or adjustment without medium). Keep in mind that the max. level must be below the radar antenna.
- Finally save your settings with **[OK]**, the adjustment is finished. Keep in mind that this adjustment refers only to the measurement loop selected by you initially. All other measurement loops must be adjusted separately, if necessary.

Meas. loop - Damping

To suppress fluctuations in the measured value display, e.g. caused by an agitated product surface, a damping can be set. This time can be between 0 and 999 seconds. Remember that the reaction time of the entire measurement will then be longer and the sensor will react to measured value changes with a delay. In general, a period of a few seconds is sufficient to smooth the measured value display.

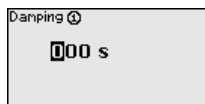

- Enter the requested parameters via the appropriate keys and save your settings with **[OK]**.

Meas. loop - Linearization curve

A linearisation is necessary for all vessels in which the vessel volume does not increase linearly with the level, for example a horizontal cylindrical or spherical tank. Corresponding linearisation curves are preprogrammed for these vessels. They represent the correlation between the level percentage and vessel volume. By activating the appropriate curve, the volume percentage of the vessel is displayed correctly. If the volume should not be displayed in percent but e.g. in l or kg, a scaling can be also set.

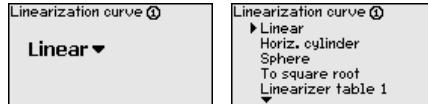

→ Enter the requested parameters via the appropriate keys and save your settings with **[OK]**.

Meas. loop - Scaling

Scaling means converting the measured value into a certain parameter and unit. The linearized percentage value is the source signal which is used as basis for the scaling. The indication can then show the volume in litres e.g., instead of the percentage value. Indication values from max. -99999 to +99999 are possible.

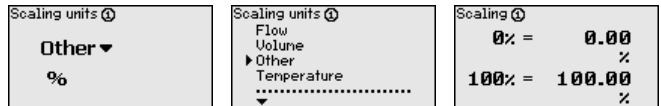

→ Enter the requested parameters via the appropriate keys and save your settings with **[OK]**.

Meas. loop - Meas. loop TAG

In this menu item you can enter an unambiguous designation for each measurement loop, e.g. the measurement loop name or the tank or product designation. In digital systems and in the documentation of larger plants, a singular designation should be entered for exact identification of individual measuring points.

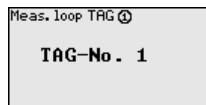

→ Enter the requested parameters via the appropriate keys and save your settings with **[OK]**.

Meas. loop - Outputs - Relays outputs

Under "Outputs" you will find the relay/current outputs. Under relay output, the requested mode ("Overfill protection" or "Dry run protection") must first be selected.

- **Overfill protection:** Relay is switched off when the max. level is exceeded (safe currentless state), relay is switched on again when the level falls below the min. level (switch-on point < switch-off point)
- **Dry run protection:** Relay is switched off when the level falls below the min. level (safe currentless state), relay is switched on again when the max. level is exceeded (switch-on point > switch-off point)

Additional modes such as "Switching window", "Flow" and "Tendency" can be only adjusted via PACTware and DTM.

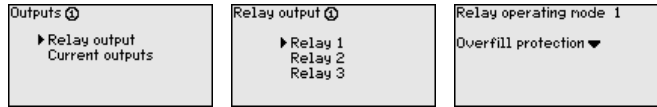

Select the requested mode and save with [OK]. By pushing [->], you reach the next menu item.

Now enter the reference value to which the relay switching points relate. By pushing [->], you reach the next menu item.

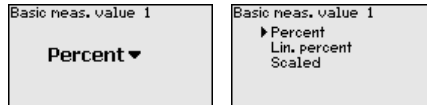

Enter now the switching points for switching the relay on and off. The parameter to which they refer can also be selected.

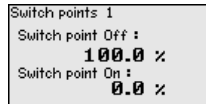

In the following window the reaction of the relay in case of failure can be determined. Here you can define whether, in case of failure, the switching condition of the relay remains unchanged or the relay is switched off.

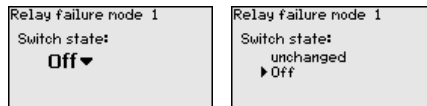

Meas. loop - Outputs - Current outputs

The current output is used to transfer the measured value to a higher ranking system, for example to a PLC, a control system or a measured value indication. This is an active output, i.e. a current is provided actively. The processing unit must hence have a passive current input.

The characteristics of the current outputs can be set to 0 ... 20 mA, 4 ... 20 mA or inverted. The reaction in case of failure can be also adapted to the requirements. The parameter, i.e. measured variable, to which they refer can also be selected.

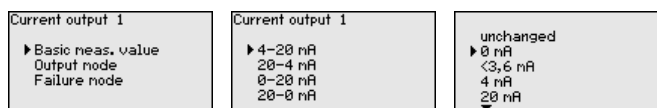
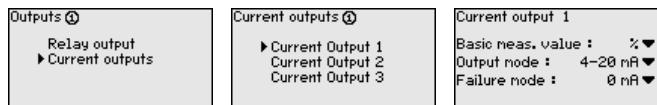

→ Enter the requested parameters via the appropriate keys and save your settings with [OK].

Display

In the menu item " *Display - Indication value*", you can set the requested indication value. The following options are available:

- **Percent:** adjusted measured value without taking a saved linearisation into account
- **Lin. percent:** adjusted measured value taking a saved linearisation into account
- **Scaled:** adjusted measured value taking a saved linearisation into account as well as the values entered under " *Scaling*"
- **Sensor value:** input value delivered by the sensor. Displayed in the selected adjustment unit

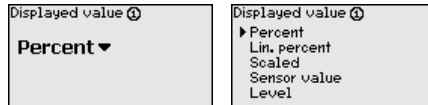

→ Enter the requested parameters via the appropriate keys and save your settings with **[OK]**.

Diagnostics

When the instrument displays a fault signal, further information is available under the menu item " *Diagnosis - Device status*".

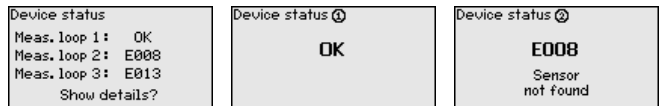

Service - Simulation

The simulation of a measured value is used to check the outputs and connected components. The simulation can be applied to the percentage value, the lin. percentage value and the sensor value.



Note:

Please note that connected system components (valves, pumps, motors, control systems) are influenced by the simulation, thus unintentional plant operating conditions can occur. The simulation is terminated automatically after approximately 10 minutes.

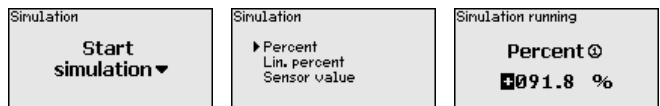

→ Carry out your settings via the appropriate keys and save with **[OK]**.

Service - Reset

There are two reset modes:

- **Reset to default:** with only a few exceptions, all settings will be reset to default values. Exceptions are: Host name, IP address, subnet mask, time, language.
- **Reset on measurement loop:** The settings of the selected measurement loop will be set to default. The measurement loop is deactivated and the TAG name reset to default.

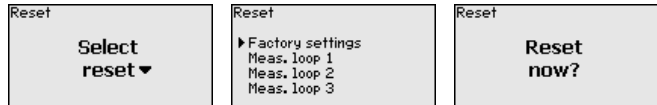

Service - Display language

In the menu item " *Display - Language*", the requested display language can be adjusted. The following languages are available:

- German
- English
- French
- Spanish
- Russian
- Italian
- Dutch

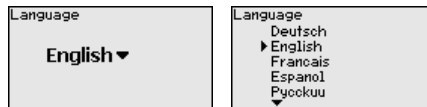

→ Carry out your settings via the appropriate keys and save with **[OK]**.

Service - Access protection

The controller can be locked and the data transmission encrypted as a protection against unauthorized changes of the set parameters. The following options are possible:

- Access protection of the on-site adjustment via keyboard by means of a PIN
- Access protection of the DTM adjustment via the USB/Ethernet/RS232 interface by means of a password (can be only activated via DTM)
- Encryption of the DTM data transmission with connection via Ethernet/RS232 interface
- Access protection of the integrated web server by means of a password (can be only activated via DTM)



Service - Access protection - PIN

Modification of parameters through the instrument keyboard can be avoided by activating a PIN. The measured value display and display of all parameters is still possible.



Note:

By activating the PIN, only parameter changes via the front side instrument keyboard are locked. Via the interfaces and the respective DTM, the complete access to the instrument is still possible. If you want to stop this access, then the DTM adjustment can be completely locked by activating a password. The activation of this locking only possible via the DTM and not via the keyboard.

Service - Access protection - DTM remote access

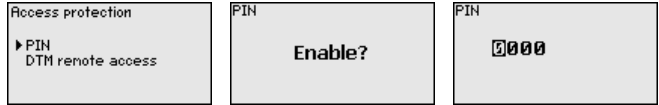

Instruments with RS232/Ethernet option can be protected against wiretapping and manipulation of the data transmission from remote. For this, activate under "DTM remote access" the encryption of the data transmission. With active encryption, it is necessary to enter once the instrument key (PSK) during connection for DTM access via the Ethernet/RS232 interface. The instrument key is stored on the PC and must not be entered again when connecting with this PC. Each instrument is provided with an individual instrument key consisting of 20 capital letters. This key can be read out directly on the instrument display in the menu "Info".

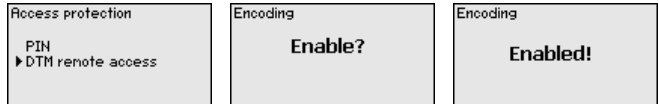

Service - Sensor address

With every 4 ... 20 mA/HART sensor, the measured value can be transmitted via analog current signal or digital HART signal. This is regulated via the HART mode or the address. If a HART sensor is set to address 0, the sensor is in the standard mode. Here the measured value is transmitted digitally on the 4 ... 20 mA cable.

In mode HART Multidrop, an address from 1 ... 15 is assigned to the sensor. By doing so, the current is fixed limited to 4 mA and the measured value transmission is only made digitally.

Each sensor connected to VEGAMET 625 must operate in mode HART multidrop and must be provided with different addresses in the range between 01 ... 15. Via the menu item "Sensor address", it is possible to change the address of the connected sensor. For this purpose, enter the previous address of the sensor (factory setting 0) and in the next window the new address.



Note:

When addresses are being assigned, only one sensor with the same address must be connected on the bus. If this is not the case, the sensor cannot be accessed and it is not possible to assign an address.



First of all, enter the previous address of the sensor to be modified (factory setting 0), then you can enter the selected HART address in the range of 01 - 15 in the menu "New address". Make sure that no address is assigned twice.

Service - Data transmission

On instrument versions with integrated RS232/Ethernet interface, a manual data transmission to a VEGA Inventory System server can be

triggered, e.g. for test purposes. The requirement is that a respective event has been configured in advance via PACTware/DTM.

Data transfer Send VEGA Invent. Sys data?	Data transfer Trigger data transfer?	Status data transfer Message transmission is being prepared
---	--	---

Info

In the menu item "Info" the following information is available:

- Sensor type and serial number
- Date of manufacture and software version
- Date of last change using PC
- Instrument features
- MAC address (with interface option Ethernet)
- Instrument key (PSK) for DTM remote access (with interface option Ethernet/RS232)

Date of manufacture 17. Aug. 2012 Software version 1.95	Date of last change using PC 15. Aug. 2012	MAC address 00:30:87:D8:5D:18
--	---	---

Optional settings

Additional adjustment and diagnostics options are available via the Windows software PACTware and the suitable DTM. Connection can be made optionally via the built-in standard interface or one of the optionally offered interfaces (RS232/Ethernet). Further information is available in chapter "Parameter adjustment with PACTware", in the online help of PACTware or the DTM as well as in the operating instructions manual "RS232/Ethernet connection". An overview of the standard functions and their adjustment options can be found in chapter "Functional overview" in the "Supplement".

6.3 Menu schematic



Information:

Depending on the instrument version and application, the highlighted menu windows are not always available.

Measured value indication

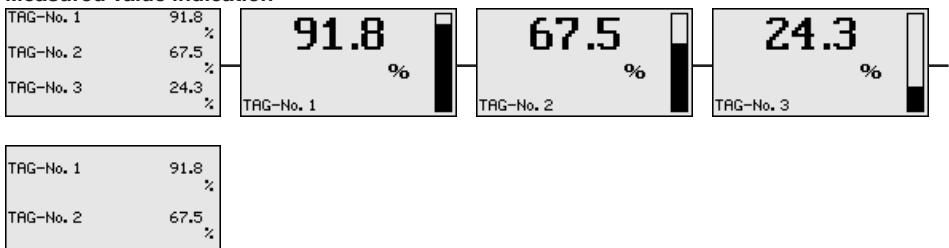

Device settings

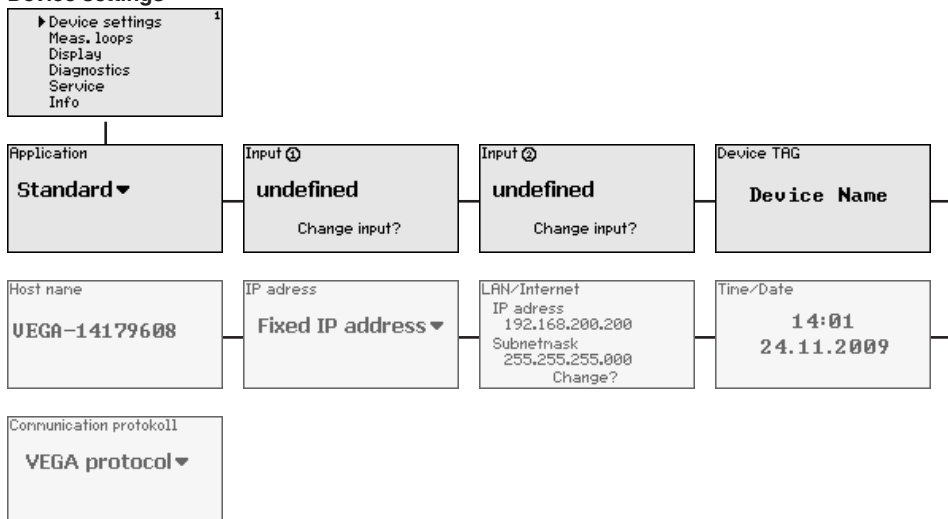

Device settings - Input

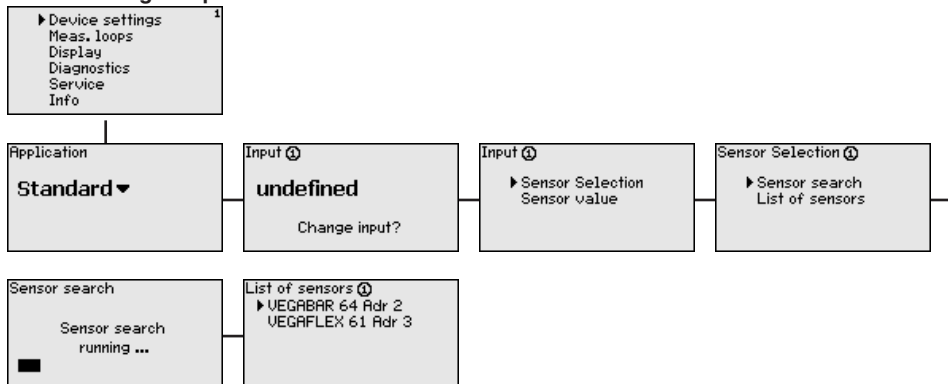

Measurement loops 1/2 - Input

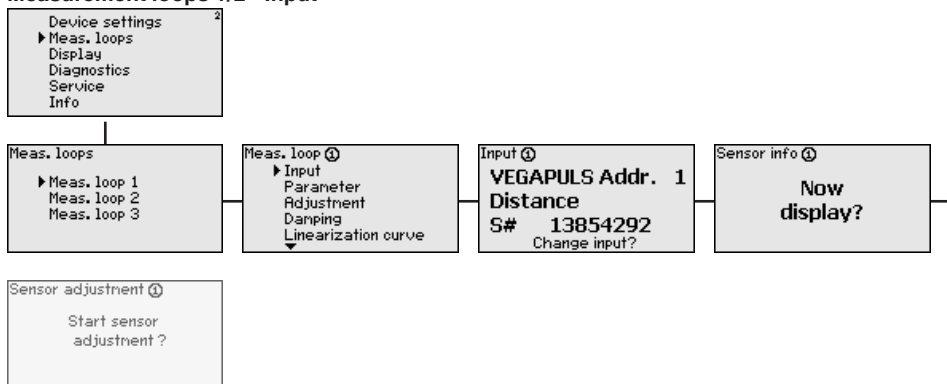

Meas. loop 1/2 - Change input

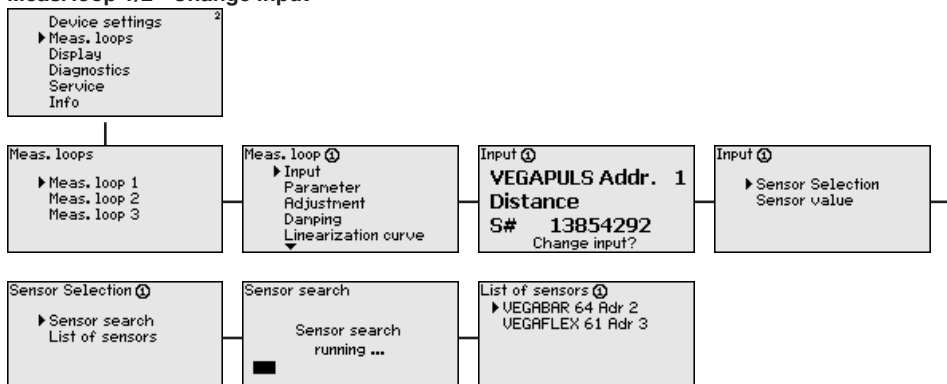

Meas. loop 3 - Change input

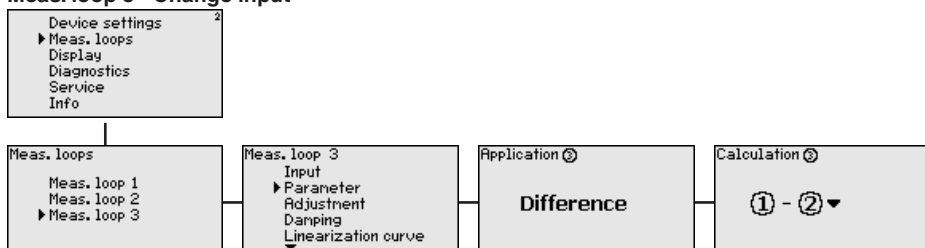

Meas. loop 1/2 - Parameter

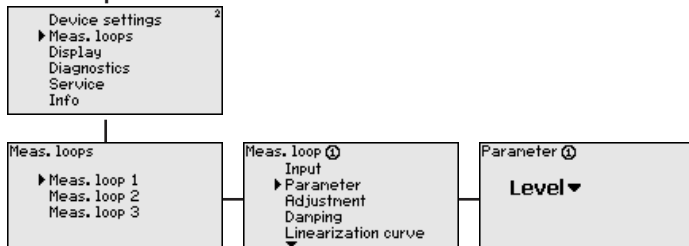

Meas. loop 3 - Measured variable

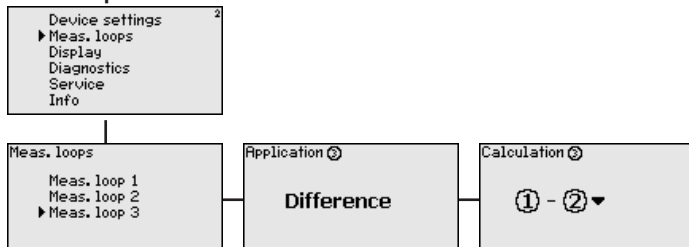

Meas. loop - Adjustment

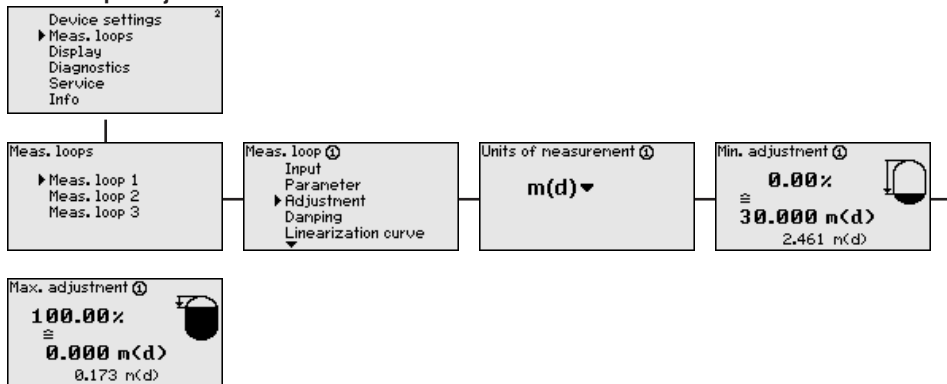

Meas. loop - Damping

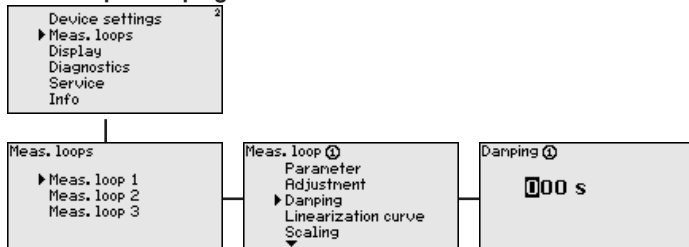

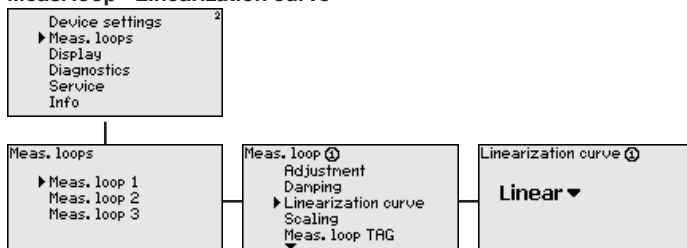
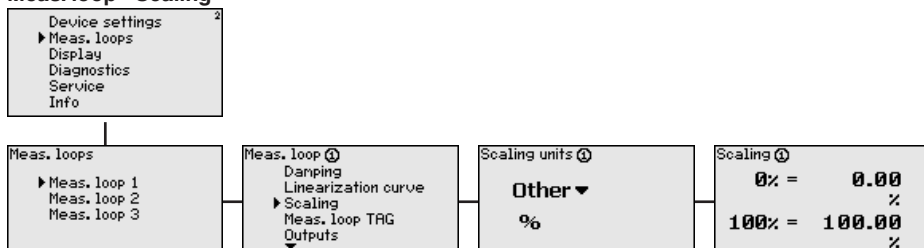
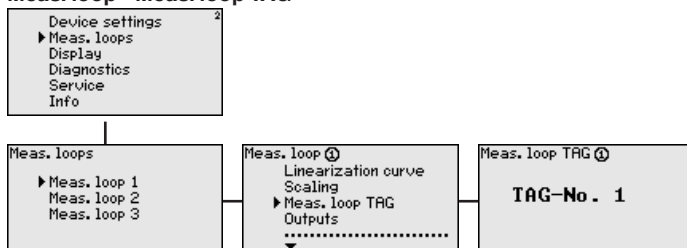
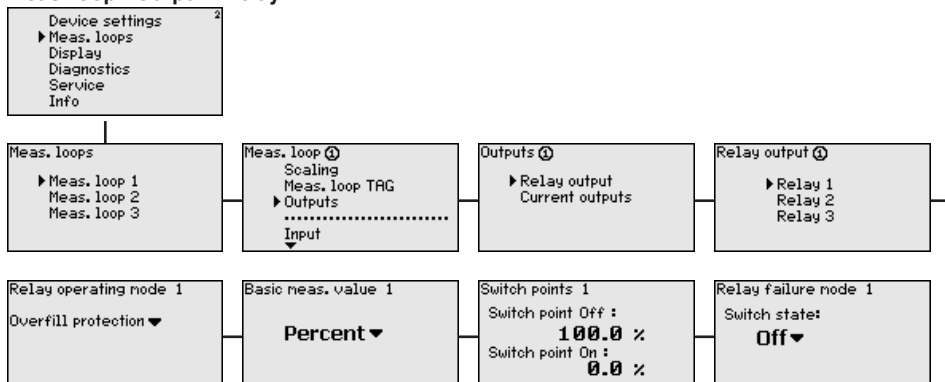
Meas. loop - Linearization curve**Meas. loop - Scaling****Meas. loop - Meas. loop TAG****Meas. loop - Output - Relay**

Meas. loop - Output - Current outputs

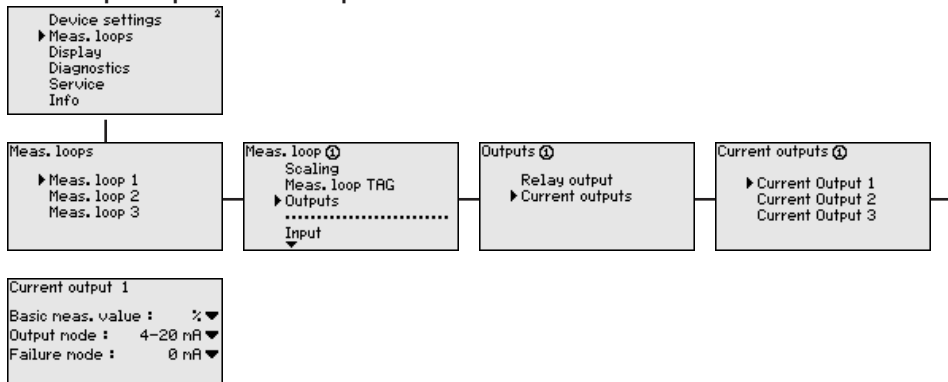

Display

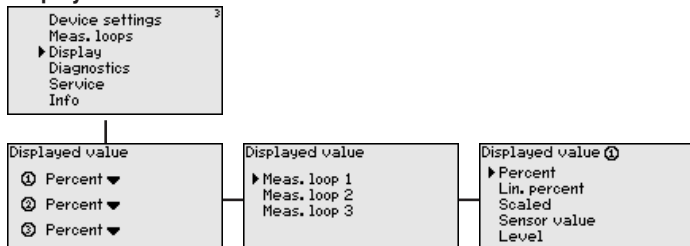

Diagnostics

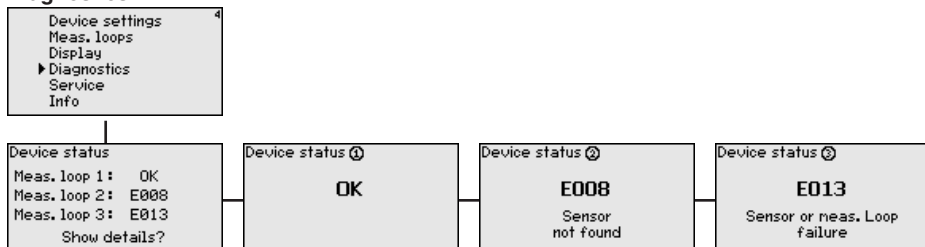

Service

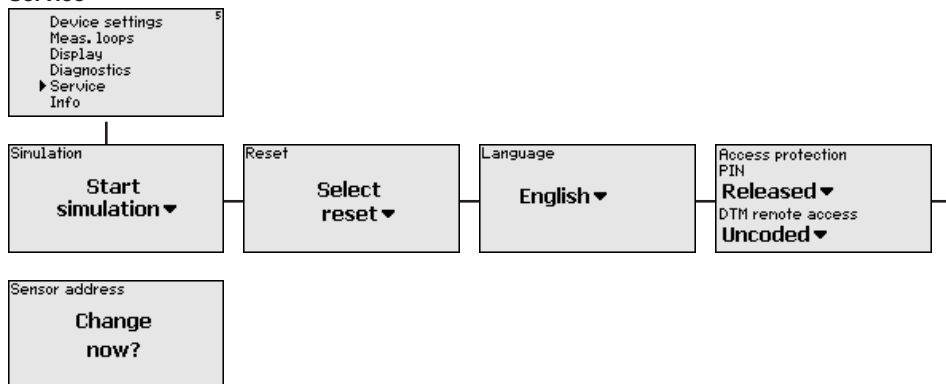

Service - Simulation

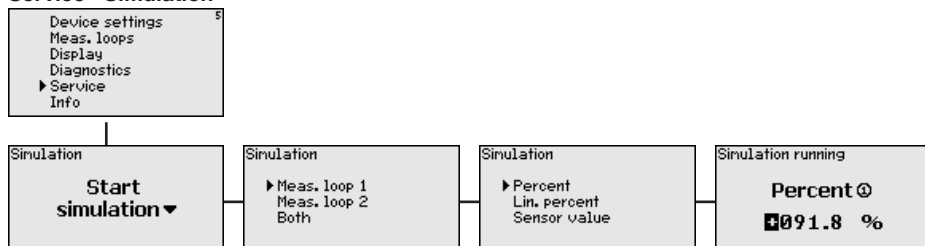

Service - Reset

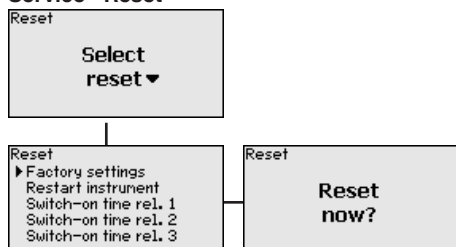

Service - Access protection - PIN

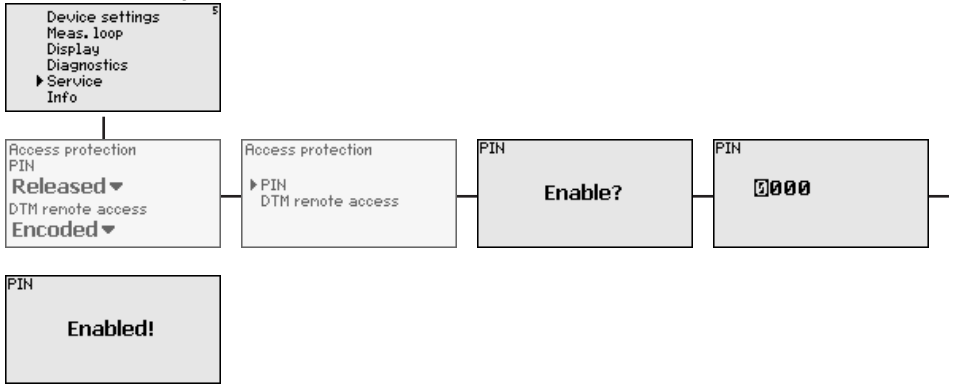

Service - Sensor address

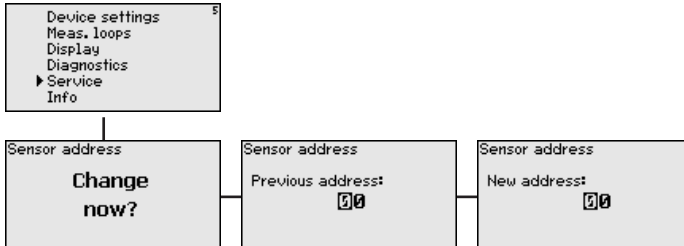

Service - Data transmission (only with option RS232/Ethernet interface)

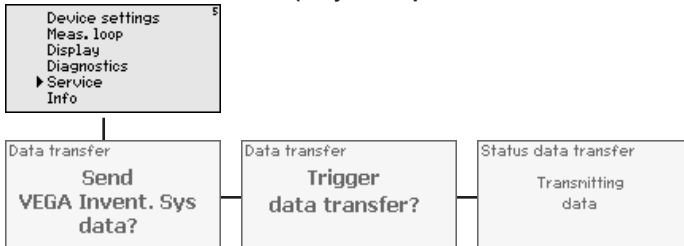

Info



7 Setup with PACTware

7.1 Connect the PC

Connection of the PC via VEGACONNECT

For a brief connection of the PC, e.g. for parameter adjustment, connection can be carried out via the VEGACONNECT 4 interface converter. The necessary I²C interface on the front is available on all instrument versions. On the computer side, connection is carried out via the USB interface.

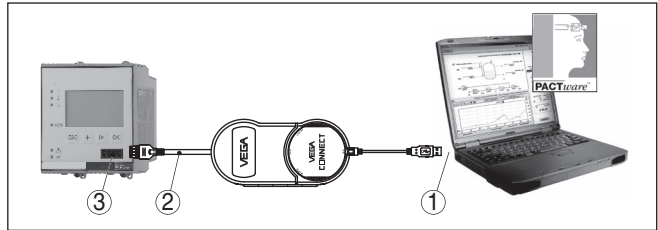

Fig. 6: Connection via VEGACONNECT

- 1 USB interface of the PC
- 2 I²C connection cable of VEGACONNECT 4
- 3 I²C interface

Connection of the PC via Ethernet

With the Ethernet interface, the instrument can be connected directly to an existing PC network. Any standard patch cable can be used. A cross-over cable must be used when connecting the instrument directly to the PC. To reduce EMC interferences, the supplied split-fer-rite should be connected to the Ethernet cable. Each instrument can then be accessed from anywhere in the network by a unique Host name or its own IP address. The parameter adjustment of the instrument via PACTware and DTM can be carried out from any PC. The measured values can be made available to individual users within the company network as HTML chart. As an alternative, the independent, time or event-controlled transmission of measured values via e-mail is also possible. The measured values can also be called up via a visualisation software.



Note:

To contact the instrument, the IP address or the Host name must be known. You can find this information under the menu item " *Device settings*". If you modify these entries, the instrument has to be restarted afterwards. Then the instrument can be reached from everywhere in the network via its IP address or Host name. These specifications must also be entered in the DTM (see chapter " *Parameter adjustment with PACTware*"). If the encrypted DTM remote access is activated in the controller, the instrument key (PSK) must be entered during the first connection. This key can be read out via the on-site adjustment in the info menu of the controller.

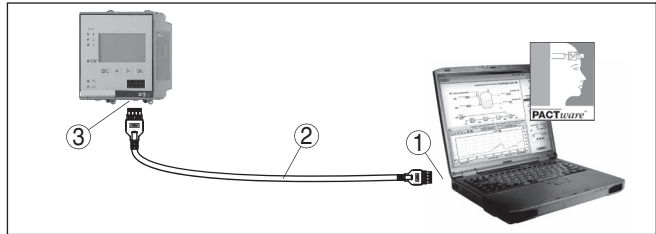

Fig. 7: Connection of the PC via Ethernet

- 1 Ethernet interface of the PC
- 2 Ethernet connection cable (Cross-Over cable)
- 3 Ethernet interface

Connection of the modem via RS232

The RS232 interface is particularly suitable for simple modem connection. External analog, ISDN and GSM modems with standard interface can be used. The necessary RS232 modem connection cable is included with the delivery. To reduce EMC interference, you should mount the supplied ferrite bead on the RS232 modem connection cable. Via a visualisation software, measured values can be retrieved remotely and further processed. Alternatively, autonomous time or event controlled transmission of measured values via e-mail is also possible. Remote parameter adjustment of the instrument and the connected sensors is also possible with PACTware.

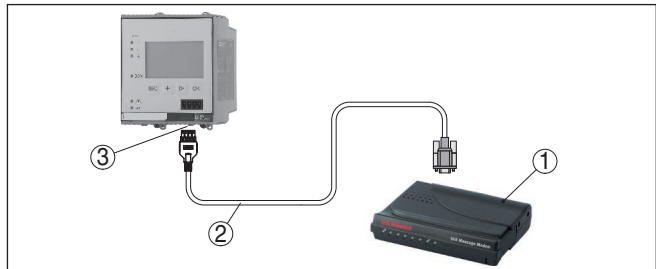

Fig. 8: Connection of the modem via RS232

- 1 Analogue, ISDN or GSM modem with RS232 interface
- 2 RS232 modem connection cable (in the scope of delivery)
- 3 RS232 interface (RJ45 plug connection)

Connection of the PC via RS232

Via the RS232 interface, direct parameter adjustment and measured value retrieval from the instrument can be carried out with PACTware. Use the RS232 modem connection cable supplied with the instrument and an additionally connected null modem cable (e.g. article no. LOG571.17347). To reduce EMC interference, you should mount the supplied ferrite bead on the RS232 modem connection cable.

If there is no RS232 interface available on the PC or if it is already occupied, you can also use a USB-RS232 adapter (e.g. article no. 2.26900).

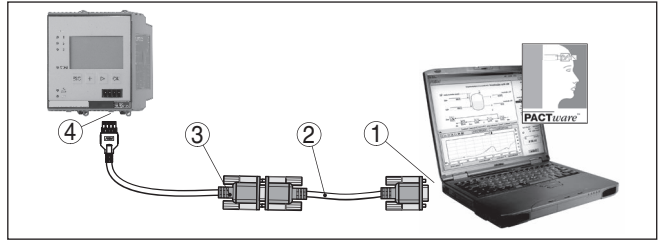

Fig. 9: Connection of the PC via RS232

- 1 RS232 interface of the PC
- 2 RS232 interlink cable (article no. LOG571.17347)
- 3 RS232 modem connection cable (in the scope of delivery)
- 4 RS232 interface (RJ45 plug connection)

Assignment RS232 modem connection cable

①		
RXD	4	2
TXD	3	3
RTS	6	7
CTS	2	8
GND	5	5
DTR	1	4

Fig. 10: Connection assignment of the RS232 modem connection cable

- 1 Name of the interface cable
- 2 Assignment of the RJ45 plug (view of contact side)
- 3 Assignment of the RS232 plug (view of soldering side)

7.2 Parameter adjustment with PACTware

Prerequisites

As an alternative to the integrated display and adjustment unit, the adjustment can be also carried out via a Windows PC. For this, the configuration software PACTware and a suitable instrument driver (DTM) according to the FDT standard are required. The current PACTware version as well as all available DTMs are compiled in a DTM Collection. Furthermore, the DTMs can be integrated into other frame applications compliant with the FDT standard.



Note:

To ensure that all instrument functions are supported, you should always use the latest DTM Collection. Furthermore, not all described functions are included in older firmware versions. You can download

the latest instrument software from our homepage. A description of the update procedure is also available in the Internet.

Further setup steps are described in the operating instructions manual "*DTM Collection/PACTware*" attached to each DTM Collection and which can also be downloaded from the Internet. A detailed description is available in the online help of PACTware and the DTMs as well as in the supplementary instructions manual "*RS232/Ethernet connection*".



Information:

To access the connected sensors, the addressing must be already carried out, see chapter "*Setup procedure - Set HART address*". If the addressing should be carried out now via PACTware, then also only one sensor must be connected.

Connection via Ethernet

To contact the instrument, the IP address or the Host name must be known. You can find this information under the menu item "*Device settings*". If the project setup is carried out without assistant (offline mode), IP address and subnet mask or the Host name must be entered in the DTM. Click in the project window with the right mouse key on the Ethernet DTM and choose "*Add. functions - Modify DTM addresses*". If the encrypted DTM remote access is activated in the controller, the instrument key (PSK) must be entered during the first connection. This key can be read out via the on-site adjustment in the info menu of the controller.

Standard/Full version

All device DTMs are available as a free-of-charge standard version and as a full version that must be purchased. In the standard version, all functions for complete setup are already included. An assistant for simple project configuration simplifies the adjustment considerably. Saving/printing the project as well as import/export functions are also part of the standard version.

In the full version there is also an extended print function for complete project documentation as well as a save function for measured value and echo curves. In addition, there is a tank calculation program as well as a multiviewer for display and analysis of the saved measured value and echo curves.

7.3 Setup web server/e-mail, remote enquiry

Setup and application examples of the web server, the e-mail functions and the visualisation VEGA Inventory System are provided in the supplementary instructions "*RS232/Ethernet connection*".

The connection via Modbus-TCP or ASCII protocol is described in the supplementary instruction manual "*Modbus-TCP, ASCII protocol*".

Both supplementary instruction manuals are included with every instrument with RS232 or Ethernet interface.

8 Application examples

8.1 Level measurement in a horizontal cylindrical tank with overflow protection/dry run protection

Functional principle

The level is detected by a sensor and transmitted to the controller by means of a 4 ... 20 mA signal. Here, an adjustment is carried out, converting the input value delivered by the sensor into a percentage value.

Due to the geometrical form of the horizontal cylindrical tank, the vessel volume does not increase linearly with the level. This can be compensated by selecting the linearisation curve integrated in the instrument. This curve states the relationship between percentage level and vessel volume. If the level is to be displayed in litres, a scaling must also be carried out. For this purpose, the linearised percentage value is converted into a volume, for example with the unit litre.

Filling and emptying are controlled via relay 1 and 2 which are integrated in the controller. During filling, relay mode "Overflow protection" is set. The relay is thus switched off (safe currentless state) when the max. level is exceeded, and switched on again when the min. level is underrun (switch-on point < switch-off point). During emptying, mode "Dry run protection" is used. This relay is thus switched off when the min. level is underrun (safe currentless condition), and switched on again when the max. level is exceeded (switch-on point > switch-off point).

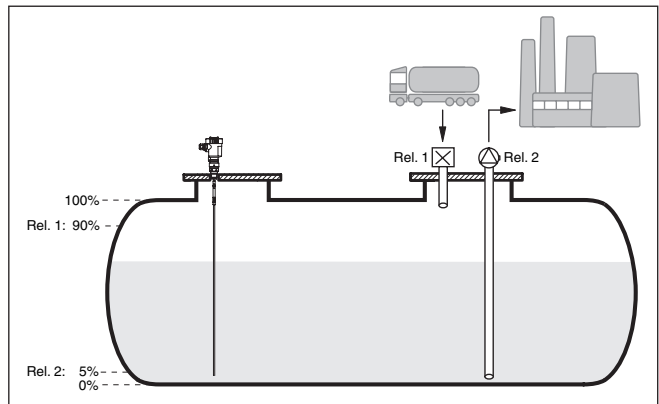

Fig. 11: Example of level measurement, horizontal cylindrical tank

Example

A horizontal cylindrical tank has a capacity of 10000 litres. The measurement is carried out with a level sensor operating according to the guided microwave principle. The filling by a tank car is controlled via relay 1 and a valve (overflow protection). The discharge is carried out via a pump and is controlled by relay 2 (dry run protection). The max. volume should be at 90 % level, this means 9538 litres with a stand-

ard vessel (according to sounding table). The min. level should be set to 5 %, this corresponds to 181 litres. The volume is to be displayed in litres.

Adjustment

Carry out the adjustment in the controller as described in chapter "Setup steps". No further adjustment may be carried out in the sensor itself. For the max. adjustment, fill the vessel up to the requested max. level and accept the actually measured value. If this is not possible, the corresponding current value can also be entered. For the min. adjustment, empty the vessel down to the min. level or enter the corresponding current value.

Linearisation

To display the percentage level correctly, select under "Measurement loop - Linearization curve" the entry "Horiz. cylindrical tank".

Scaling

To display the volume in litres, you have to enter "Volume" as the unit in litres under "Measurement loop - Scaling". The allocation is then carried out, in this example 100 % \triangleq 10000 litres and 0 % \triangleq 0 litres.

Relay

Percent is selected as reference value for the relays. The mode of relay 1 is set to overflow protection, relay 2 must be activated and gets mode dry run protection. To ensure that the pump switches off in case of failure, the reaction in case of failure should be set to switching status OFF. The switching points are set as follows:

- **Relay 1:** Switch-off point 90 %, switch-on point 85 %
- **Relay 2:** Switch-off point 5 %, switch-on point 10 %



Information:

The switch-on and switch-off point of the relays must not be set to the same switching point because this would cause a continuous switching on and off when this threshold is reached. To avoid this effect also with fluctuating medium surfaces, it is a good idea to set a difference (hysteresis) of 5 % between the switching points.

8.2 Screen control in a hydroelectric power station

Functional principle

A water power turbine must be protected against foreign material in the flowing water. Such debris gets stuck on the grate like on a sieve. It must be removed cyclically so that max. flow is ensured. If too much debris remains on the grate, the water level in front of the dam will rise because the total water volume can no longer flow through. The difference in level in front of and behind the weir is thus a measure of the degree of blockage and can be used to control the grate cleaner.

Example

The water level in front of the grate (upstream water) and behind the grate (downstream water) is measured in each case with a VE-GAWELL 72 HART. VEGAMET 625 calculates the difference (h3) between these two levels (measurement loop 3). If this difference is too high, a signal is outputted by one of the integrated relays, triggering the weir cleaning system. In this example we assume a max. level of 2 m, the weir cleaning system is to be started at a difference of 20 cm.

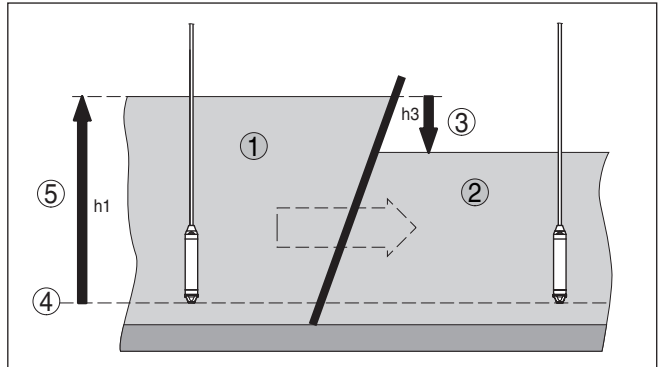

Fig. 12: Differential measurement - screen control

- 1 Upstream water
- 2 Tailwater
- 3 Difference h_3
- 4 Reference plane
- 5 max. level h_1

The following steps are necessary to set up the measuring point:

- **Selection of the application**

- Select under "Device settings - Application" the entry "Standard" and confirm with **[OK]**. Via the **[->]** key you reach the next step.

- **Addressing of the sensors**

- Since both sensors are addressed via HART multidrop, the sensor addressing must be carried out first (see chapter "Setup procedure")
- Connect sensor 1 for upstream water
- Enter now under "Service - Change sensor address" in the menu item "New address" HART address "01"
- Disconnect sensor 1 and connect sensor 2 for downstream water
- Assign HART address "02"
- Reconnect sensor 1

- **Assignment of the inputs and measurement loops**

- **Measurement loop 1 (upstream water):** Start under "Measurement loops - Meas. loop 1 - Input - Change input 1 - Sensor selection" the menu item "Sensor search". If the addressing is correct, both sensors must be displayed. Select the first sensor with address 01
- **Measurement loop 2 (downstream water):** Go under "Measurement loops - Measurement loop 1 - Input - Change input 1 - Sensor selection" to the menu item "Sensor list". Select the second sensor with address 02
- **Measurement loop 3 (difference):** This measurement loop calculates automatically without further settings the difference between upstream water and downstream water (measurement loop 1 minus measurement loop 2)

- **Adjustment**
 - **Measurement loop 1 (upstream water):** Select under "*Measurement loops - Meas. loop 1 - Adjustment*" in the menu item "*Adjustment unit*" the unit "*m*" (meter) and the density unit "*1.000 kg/dm^{3m}*". Enter under "*Min. adjustment*" 0.00 m and under "*Max. adjustment*" the max. level in meters (h1). In this example enter 2 m.
 - **Measurement loop 2 (downstream water):** Carry out the adjustment with the same specifications as for measurement loop 1
 - **Measurement loop 3 (difference):** The adjustment of the upstream water is entered automatically (0 % \pm 0.00 m, 100 % \pm 2 m)
- **Relay configuration**
 - Select under "*Measurement loops - Meas. loop 3 - Outputs - Relay outputs - Relay 3 - Overfill protection - Percent*" the menu item "*Switching points relay 3*". Enter for switching point "*OFF*" 10 % and for switching point "*ON*" 5 %. With these settings, the relay deenergizes at a difference of 20 cm and switches on again at 10 cm. Hence the cleaning procedure starts at a gauge difference of over 20 cm and runs until the difference is again below 10 cm.

8.3 Interface measurement with VEGAFLEX

In an interface measurement, there are two different media which do not mix, e. g. water and oil or solvents. To detect the volume of both products, it is necessary to detect the height of the upper liquid (level) and the interface between the two products. A VEGAFLEX is required as a sensor to transmit the distance to the upper medium as well as the distance to the interface. Via the adjustment in VEGAMET 625, the total level, the interface and the layer thickness of the upper medium can be calculated and displayed.

The following steps are necessary to set up the measuring point:

- **Selection of the application**
 - Select under "*Device settings - Application*" the entry "*Interface measurement*" and confirm with **[OK]**. Via the **[->]** key you reach the next step.
- **Assignment of the inputs and measurement loops**
 - Select "*Input - Change input*". Now the automatic sensor search is started and if connected correctly, VEGAFLEX will be displayed. Accept the selection with **[OK]** and go to the entry of the dielectric constant with **[->]**. The input variables are assigned automatically to the following measurement loops:
 - Meas. loop 1: Interface (level of the lower medium)
 - Meas. loop 2: Level (total level of both products)
 - Meas. loop 3: Layer thickness (thickness of the upper medium)
- **Enter dielectric constant**
 - Enter here the exact dielectric constant of the upper medium. This figure is then transferred automatically to VEGAFLEX. Further information on the dielectric constant is available in the

operating instructions manual of VEGAFLEX. In this application, do **not** enter a dielectric constant directly in VEGAFLEX, because this value will be automatically overwritten by VEGAMET 625

● **Adjustment**

- Each VEGAFLEX is shipped with default settings. The values of this adjustment are automatically transferred to VEGAMET 625 during the setup of the interface measurement. Hence, manual adjustment is usually not necessary. Should the instrument require a special adjustment, this adjustment can be carried out any time under "Measurement loops - Adjustment". Keep in mind that this adjustment must then be carried out separately for all three measurement loops.

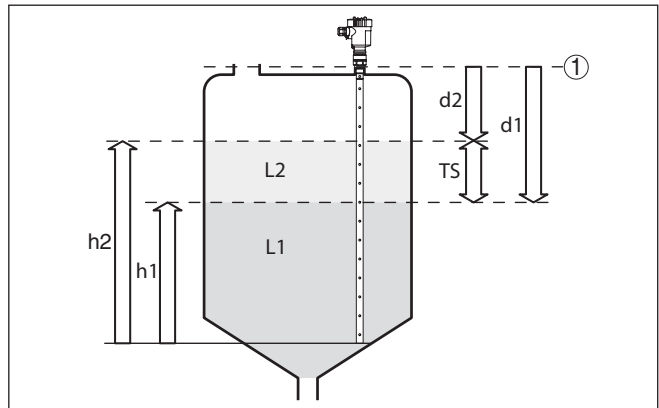

Fig. 13: Interface measurement

1 Reference plane

d1 Distance to the interface, meas. loop 1

d2 Distance to the level, meas. loop 2

TS Thickness of the upper medium ($d1-d2$), meas. loop 3 (displayed value)

h1 Height - Interface (displayed value)

h2 Height - Level (displayed value)

L1 Lower medium

L2 Upper medium



Note:

When using a VEGAFLEX 8x, this sensor must first be set up for interface measurement. VEGAFLEX must not be locked by the PIN, because VEGAMET requires write access.

8.4 Pump control 1/2 (run time controlled)

Pump control 1/2 is used to control several pumps with the same function, in dependence on their respective elapsed running times. The pump with the shortest elapsed running time is switched on and the pump with the longest running time switched off. In case of increased pumping requirement, all pumps can also run at the same time, in dependence on the entered switching points. This measure

achieves an even utilization of the pumps and increases operational reliability.

All relays with activated pump control are not assigned to a certain switching point but are switched on or off depending on the accumulated operating time. The controller selects the relay with the shortest elapsed operating time when the switch-on point is reached and the relay with the longest elapsed operating time when the switch-off point is reached.

This pump control system offers two different options:

- Pump control 1: The upper switching point determines the switch-off point for the relay, whereas the lower switching point determines the switch-on point
- Pump control 2: The upper switching point determines the switch-on point for the relay, whereas the lower switching point determines the switch-off point

Example

Two pumps should empty the vessel when a certain level is reached. At 80 % filling, the pump with the shortest elapsed running time should switch on. If the level nevertheless increases, a second pump should switch on at 90 %. Both pumps should switch off again at 10 % filling.

Setup

Select in the DTM navigation section the menu items " *Meas. loop - Outputs - Relay*".

- Set mode " *Pump control 2*" for relay 1 and 2.
- Enter the switching points for the affected relays as follows:
 - Relay 1 upper switching point = 80.0 %
 - Relay 1 lower switching point = 10.0 %
 - Relay 2 upper switching point = 90.0 %
 - Relay 2 lower switching point = 10.0 %

The function of pump control 2 is shown in detail in the following diagram. The previously described example is used as a basis.

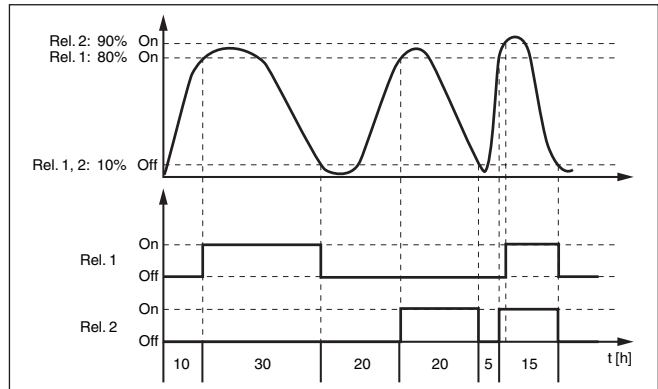

Fig. 14: Example of pump control 2

Switch-on behaviour of pump control 2

When the controller is switched on, the relays are at first in a switched-off status. Depending on the actual input signal and the switched-on period of the individual relays, the following relay switching conditions can occur after the start procedure:

- Input signal is higher than the upper switching point -> Relay with the shortest switched-on period is switched on
- Input signal is between lower and upper switching point -> Relay remains switched off
- Input signal is smaller than the lower switching point -> Relay remains switched off

Option, forced switchover If the level has not changed over a longer period, the same pump would always remain switched on. Via the parameter " *Switchover time*", a time can be preset which, after it is elapsed, forces a switchover of the pump. Which pump is switched on depends on the selected pump mode. If all pumps are already switched on, the pump remains switched on. This function can only be set with a PC and DTM.



Note:

If the pump is already switched on when the forced switchover is activated, the timer is not started. Only after the pump is switched off and on again will the timer start. If a switch-off delay is set, it will not be taken into account, i.e. the switchover is carried out exactly after the preset time for the forced switchover expires. A preset switch-on delay, however, is taken into account, i.e. the forced switchover to another pump is carried out after the preset time expires. Before the newly selected pump switches on, the preset switch-on delay for this pump must have expired.

8.5 Tendency recognition

Functional principle

The function of the tendency recognition is to recognize a defined change within a certain time period and transfer this information to a relay output.

Principle of operation

The information for tendency recognition is generated from the measured value change per time unit. The output variable is always the measured value in percent. This function can be configured for rising and falling tendency. The actual measured value is determined and summed with a sampling rate of one second. After the max. reaction time has elapsed, the average value is generated from this sum. The real measured value change results from the newly calculated average value minus the previously calculated average value. If this difference exceeds the defined percentage value, the tendency recognition function responds and the relay deenergises.



Note:

Activation and configuration of tendency recognition requires PACT-ware with the suitable DTM. The respective parameters cannot be set via the integrated display and adjustment unit.

Parameter

- **Measured value change higher:** Measured value change per time unit, at which the tendency recognition should respond
- **Max. reaction time:** Time after which a new average value is calculated and the measured value change is recalculated
- **Hysteresis:** is automatically always 10 % of the value of "Measured value change larger than"
- **Reaction in case of failure:** In case of a failure, the relay goes into the defined condition

**Note:**

After a switching on or a fault occurs, two complete cycles must elapse before a measured value difference can be calculated and a tendency output.

Example

The level in a basin is to be monitored for rising tendency. If the rise is higher than 25 % per minute, an additional emptying pump should be switched on. The max. reaction time should be one minute. In case of a fault, the pump should be switched off.

Setup

Select in the DTM navigation section the menu items "Meas. loop - Outputs - Relay".

- E.g. set for relay 1 the mode "Rising tendency"
- Select under "Reaction in case of failure" the option "Switching condition off"
- Enter the following values into the parameter fields:
 - Measured value more than 25 %/min.
 - Max. reaction time 1 min.

The function of the tendency recognition is shown in detail in the following diagram. The previously described example is used as a basis.

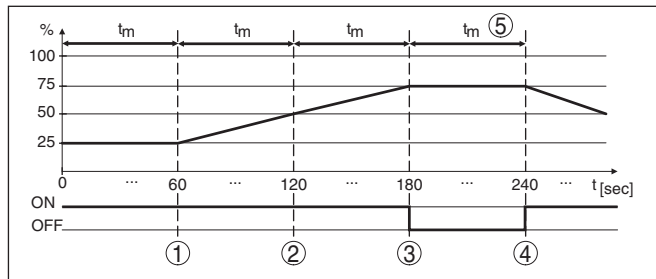

Fig. 15: Example of tendency recognition

- 1 Old average value = 25 %, new average value = 25 %
Difference < 25 % -> Relay ON
- 2 Old average value = 25 %, new average value = 37.5 %
Difference < 25 % -> Relay ON
- 3 Old average value = 37.5 %, new average value = 62.5 %
Difference = 25 % -> Relay OFF
- 4 Old average value = 62.5 %, new average value = 75 %
Difference < 25 % -> Relay ON
- 5 t_m -> max. reaction time

8.6 Flow measurement

Functional principle

For flow measurement in open flumes, a constriction or standard flume must be used. Depending on the flow volume, this constriction generates a certain level of backwater. The flow rate can be determined from the height of this backwater. The flow volume is outputted via an appropriate number of pulses on the relay or current output.

Flume

Every flume generates a different level of backwater depending on its type and version. The specifications of the following flumes are available in the instrument:

- Palmer-Bowlus flume
- Venturi flume, trapezoidal weir, rectangular overfall
- Triangular overfall, V-notch

Setup

The configuration of the flow measurement loop requires PACTware with the suitable DTMs. The example refers to a flow measurement with a radar sensor. The following setup steps must be carried out:

- Selection of the parameter "Flow"
- Carry out adjustment
- Select flume (linearization)
- Set scaling
- Set parameters of pulse outputs

Parameter - Flow

Select in the DTM window "Parameter" the option "Flow" with the requested unit of measurement.

Adjustment

Min. adjustment: Enter the suitable value for 0 %, i.e. the distance from the sensor to the medium when there is no flow. In the following example this is 1.40 m.

Max. adjustment: Enter the suitable value for 100 %, i.e. the distance from the sensor to the medium when there is maximum flow rate. This is 0.80 m in the following example.

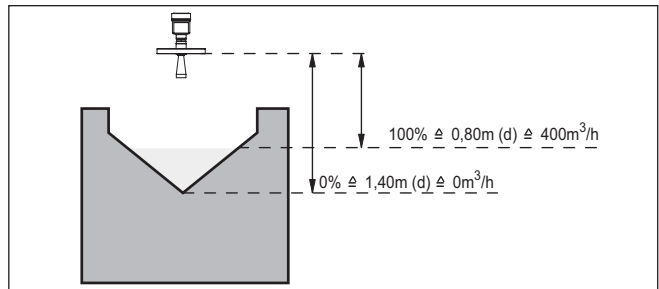

Fig. 16: Adjustment of flow measurement with V-notch

Linearisation curve

Select in the DTM window "Linearization" the option "Flow" and then the flume type used (V-notch in the above example).

Scaling

Select in the DTM window "*Scaling*" under "*Parameter*" the option "*Flow*". Then the allocation of values must be carried out, i.e. a flow volume is assigned to the 0 and 100 % values respectively. In the last step, select the requested meas. unit. For the above example: 0 % = 0 and 100 % = 400, meas. unit m³/h.

Outputs

First of all decide if you want to use a relay and/or a current output. In the DTM window "*Outputs*" you can use any of the three outputs as long as these are not yet used for other tasks.

Then select under "*Mode*" (relay) or "*Output characteristics*" (current output) the option "*Flow volume pulse*" or "*Sampling pulse*". Enter under "*Pulse output all*" the flow volume after which a pulse should be outputted (e.g. 400 m³ corresponds to one pulse per hour with a flow volume of 400 m³/h).

In mode "*Sampling pulse*" an additional pulse is output after a defined time. This means that a timer is started after each pulse, after which another pulse is output. This only applies if a pulse was not already output after the flow volume was exceeded.

Due to sludge at the bottom of the flume, it can happen that the min. level value originally set can no longer be reached. The result is that small flow quantities will be continuously detected despite the "empty" flume. The option "*Min. flow volume suppression*" offers the option of suppressing measured flow volumes below a certain percentage value for flow volume detection.

9 Diagnostics and servicing

9.1 Maintenance

Maintenance

If the device is used properly, no special maintenance is required in normal operation.

Cleaning

The cleaning helps that the type label and markings on the instrument are visible.

Take note of the following:

- Use only cleaning agents which do not corrode the housings, type label and seals
- Use only cleaning methods corresponding to the housing protection rating

9.2 Rectify faults

Reaction when malfunction occurs

The operator of the system is responsible for taking suitable measures to rectify faults.

Causes of malfunction

The device offers maximum reliability. Nevertheless, faults can occur during operation. These may be caused by the following, e.g.:

- Measured value from sensor not correct
- Voltage supply
- Interference in the cables

Fault rectification

The first measures to be taken are to check the input and output signal as well as to evaluate the error messages via the display. The procedure is described below. Further comprehensive diagnostics can be carried out on a PC with PACTware and the suitable DTM. In many cases, the causes can be determined in this way and faults rectified.

Reaction after fault rectification

Depending on the reason for the fault and the measures taken, the steps described in chapter " *Setup*" must be carried out again or must be checked for plausibility and completeness.

24 hour service hotline

Should these measures not be successful, please call in urgent cases the VEGA service hotline under the phone no. **+49 1805 858550**.

The hotline is manned 7 days a week round-the-clock. Since we offer this service worldwide, the support is only available in the English language. The service is free, only standard call charges are incurred.

9.3 Diagnosis, fault messages

Status messages

When the connected sensor is provided with a self-monitoring according to NE 107, the probably occurring status messages are passed on and output on the VEGAMET indication. Requirement is that the HART input of the VEGAMET is activated. You can find further information in the operating instructions manual of the sensor.

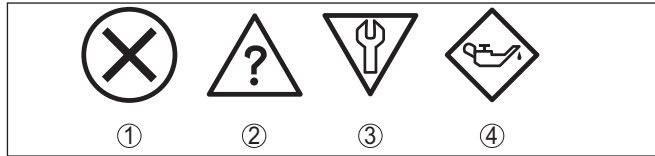

Fig. 17: Pictographs of the status messages

- 1 Failure
- 2 Function check
- 3 Out of specification
- 4 Maintenance required

Fault message

The controller and the connected sensors are permanently monitored during operation and the values entered during parameter adjustment are checked for plausibility. If irregularities occur or in case of incorrect parameter adjustment, a fault signal is triggered. In case of an instrument defect or line break/shortcircuit, a fault signal is also triggered.

The fail safe relay deenergises in case of failure, the failure indication lights and the current outputs react according to their configured control behaviour. In addition, one of the following fault messages is output on the display.

Error code	Cause	Rectification
E003	CRC error (error with self-check)	Carry out a reset Send instrument for repair
E007	Sensor type not compatible	Search for sensor again and allocate under " <i>Measuring point - Input</i> "
E008	Sensor not found	Check connection of the sensor Check HART address of the sensor
E011	No HART sensor assigned	Assign a sensor in the menu " <i>Input</i> "
E013	Sensor signals error, no valid measured value	Check sensor parameter adjustment Send sensor for repair
E016	Empty/full adjustment reversed	Carry out a fresh adjustment
E017	Adjustment span too small	Carry out a fresh adjustment and increase the distance between min. and max. adjustment
E021	Scaling span too small	Carry out a fresh scaling, increase the distance between min. and max. scaling.
E026	Units of the input variable are different (only differential measurement loop)	Adapt the units of both Use sensors with the same input variable

Error code	Cause	Rectification
E030	Sensor in boot phase Measured value not valid	Check sensor parameter adjustment
E034	EEPROM CRC error	Switch the instrument off and on Carry out a reset Send instrument for repair
E035	ROM CRC error	Switch the instrument off and on Carry out a reset Send instrument for repair
E036	Instrument software not executable (during software update and after failed update)	Wait until software update is finished Carry out another software update
E053	Sensor measuring range is not read correctly	Communication error: Check sensor cable and shielding
E062	Pulse priority too small	Increase under " <i>Output</i> " the entry " <i>Pulse output all</i> " so that max. one pulse per second is output
E110	Relay switching points too close together	Increase the difference between the two relay switching points
E111	Relay switching points interchanged	Change relay switching points for " On/Off "
E115	Several relays are assigned to the pump control which are not set to the same failure mode	All relays which are assigned to the pump control must be set to the same failure mode
E116	Several relays that are not configured with the same mode are assigned to the pump control	All relays which are assigned to the pump control must be set to the same mode

9.4 How to proceed if a repair is necessary

You can find an instrument return form as well as detailed information about the procedure in the download area of our homepage. By doing this you help us carry out the repair quickly and without having to call back for needed information.

In case of repair, proceed as follows:

- Print and fill out one form per instrument
- Clean the instrument and pack it damage-proof

- Attach the completed form and, if need be, also a safety data sheet outside on the packaging
- Ask the agency serving you to get the address for the return shipment. You can find the agency on our homepage.

10 Dismount

10.1 Dismounting steps

Take note of chapters "*Mounting*" and "*Connecting to voltage supply*" and carry out the listed steps in reverse order.

10.2 Disposal

The device is made of recyclable materials. For this reason, it should be disposed of by a specialist recycling company. Observe the applicable national regulations.

11 Certificates and approvals

11.1 Approvals for Ex areas

Approved versions for use in hazardous areas are available or in preparation for the device series.

You can find the relevant documents on our homepage.

11.2 Approvals as overfill protection

Approved versions for use as part of an overfill protection system are available or in preparation for this device series.

The corresponding approvals can be found on our homepage.

11.3 EU conformity

The device fulfils the legal requirements of the applicable EU directives. By affixing the CE marking, we confirm the conformity of the instrument with these directives.

The EU conformity declaration can be found on our homepage.

Electromagnetic compatibility

The instrument is designed for use in an industrial environment.

Nevertheless, electromagnetic interference from electrical conductors and radiated emissions must be taken into account, as is usual with a class A instrument according to EN 61326-1. If the instrument is used in a different environment, its electromagnetic compatibility with other devices must be ensured by suitable measures.

11.4 Environment management system

Protection of the environment is one of our most important duties.

That is why we have introduced an environment management system with the goal of continuously improving company environmental protection. The environment management system is certified according to DIN EN ISO 14001. Please help us fulfil this obligation by observing the environmental instructions in chapters "*Packaging, transport and storage*", "*Disposal*" of these operating instructions.

12 Supplement

12.1 Technical data

Note for approved instruments

The technical data in the respective safety instructions are valid for approved instruments (e.g. with Ex approval). In some cases, these data can differ from the data listed herein.

All approval documents can be downloaded from our homepage.

General data

Series	Module unit with plug-in socket for mounting on carrier rail (35 x 7.5 according to DIN EN 50022/60715)
Weight	500 g (1.10 lbs)
Housing materials	Noryl SE100, Lexan 920A
Socket materials	Noryl SE100, Noryl SE1 GFN3
Connection terminals	
– Type of terminal	Screw terminal
– Max. wire cross-section	1.5 mm ² (AWG 16)

Voltage supply

Operating voltage non-Ex version	
– Nominal voltage AC	24 ... 230 V (-15 %, +10 %) 50/60 Hz
– Nominal voltage DC	24 ... 230 V (-15 %, +10 %)
Operating voltage Ex version	
– Nominal voltage AC	24 ... 230 V (-15 %, +10 %) 50/60 Hz
– Nominal voltage DC	24 ... 65 V (-15 %, +10 %)
Max. power consumption	12 VA; 7.5 W

Sensor input

Number of sensors	2 x VEGA HART sensors
Type of input (selectable) ¹⁾	
– Active input	Sensor supply through VEGAMET 625
– Passive input	Sensor has an own voltage supply
Measured value transmission	
– HART multidrop protocol	digital for VEGA HART sensors
Terminal voltage	
– Non-Ex version	approx. 28 V with 2 sensors (8 mA)
– Ex version	approx. 18 V with 2 sensors (8 mA)
Current limitation	approx. 45 mA (26 mA with Ex)
Internal resistance mode passive	< 250 Ω
Adjustment range HART sensor	
– Adjustment range	± 10 % of sensor measuring range

¹⁾ Selection is made via the terminals, a mixed operation active/passive is not possible.

– min. adjustment delta	0.1 % of sensor measuring range
Connection cable to the sensor	two-wire shielded standard cable

Relay outputs

Quantity	3 x operating relay, 1 x fail safe relay
Function	Switching relay for level or pulse relay for flow/sampling pulse
Contact	Floating spdt
Contact material	AgSnO ₂ , hard gold-plated
Switching voltage	min. 10 mV DC, max. 250 V AC/DC
Switching current	min. 10 µA DC, max. 3 A AC, 1 A DC
Breaking capacity ²⁾	min. 50 mW, max. 750 VA, max. 40 W DC
Min. programmable switching hysteresis	0.1 %
– Fault signal (switch over)	Switching condition off; unchanged
Mode pulse output	
– Pulse length	350 ms

Current outputs

Quantity	3 x output
Function	Current output for level or flow/sampling pulse
Range	0/4 ... 20 mA, 20 ... 0/4 mA
Resolution	1 µA
Max. load	500 Ω
Fault signal (switch over)	0; 3,6; 4; 20; 20.5; 22 mA, unchanged
Accuracy	±20 µA (0.1 % of 20 mA)
Temperature error relating to 20 mA	0.005 %/K
Mode pulse output	
– Voltage pulse	12 V DC at 20 mA with load 600 Ω
– Pulse length	200 ms

Ethernet interface (optional)

Quantity	1 x, cannot be combined with RS232
Data transmission	10/100 MBit
Plug connection	RJ45
Max. cable length	100 m (3937 in)

RS232 interface (optional)

Quantity	1 x, cannot be combined with Ethernet
Plug connection	RJ45 (modem connection cable on 9-pole D-SUB in the scope of delivery)
Max. cable length	15 m (590 in)

²⁾ If inductive loads or stronger currents are switched through, the gold plating on the relay contact surface will be permanently damaged. The contact is then no longer suitable for switching low-level signal circuits.

Indicators

Measured value indication

- Graphic-capable LC display, with lighting 50 x 25 mm, digital and quasianalogue display
- Max. indicating range -99999 ... 99999

LED displays

- Status, operating voltage 1 x LED green
- Status fault signal 1 x LED red
- Status operating relay 1/2/3 3 x LED yellow
- Status interface 1 x LED green

Adjustment

- Adjustment elements 4 x keys for menu adjustment
- PC adjustment PACTware with respective DTM

Ambient conditions

- Ambient temperature -20 ... +60 °C (-4 ... +140 °F)
- Storage and transport temperature -40 ... +80 °C (-40 ... +176 °F)
- Relative humidity < 96 %

Electrical protective measures

Protection rating

- Instrument IP 30
- Terminal socket IP 20

Overvoltage category (IEC 61010-1)

- up to 2000 m (6562 ft) above sea level II
- up to 5000 m (16404 ft) above sea level II - Only with connected overvoltage protection
- up to 5000 m (16404 ft) above sea level I

Protection class II

Pollution degree 2

Measures for electrical separation

Reliable separation according to VDE 0106 (part 1) between voltage supply, input and digital component

- Reference voltage 250 V
- Voltage resistance of the insulation 3.75 kV

Galvanic separation between relay output and digital part

- Reference voltage 250 V
- Voltage resistance of the insulation 4 kV

Potential separation between Ethernet interface and digital part

- Reference voltage 50 V

- Voltage resistance of the insulation 1 kV
- Potential separation between RS232 interface and digital part
- Reference voltage 50 V
 - Voltage resistance of the insulation 50 V

Approvals

Instruments with approvals can have different technical specifications depending on the version. For that reason the associated approval documents of these instruments have to be carefully noted. They are part of the delivery or can be downloaded by entering the serial number of your instrument into the search field under www.vega.com as well as in the general download area.

12.2 Overview applications/functionality

The following charts provide an overview of the standard applications and functions of controllers VEGAMET 391/624/625 and VEGASCAN 693. They also give information about whether the respective function can be activated and adjusted via the integrated indicating and adjustment unit (OP) or via PACTware/DTM. ³⁾

Application/Function	391	624	625	693	OP	DTM
Level measurement	•	•	•	•	•	•
Process pressure measurement	•	•	•	•	•	•
Differential measurement	-	-	•	-	•	•
Interface measurement	-	-	•	-	•	•
Pressurized vessel	-	-	•	-	-	•
Pump control	•	•	•	-	• ⁴⁾	•
Totalizer	•	-	-	-	-	•
Tendency recognition	•	•	•	-	-	•
Flow measurement	•	•	•	-	-	•
Simulation sensor value/%-value/lin-%-value	•	•	•	•	•	•
Simulation scaled values	•	•	•	•	-	•
Live adjustment	•	•	•	•	•	-
Measured value limitation (suppression of negative measured values)	•	•	•	•	-	•
Selection linearisation curve (cylindrical tank, spherical tank)	•	•	•	•	•	•
Creation of individual linearisation curves	•	•	•	•	-	•
Allocate fail safe relay	•	•	•	•	-	•
Modify allocation of outputs	•	•	•	•	-	•
Switch on/Switch off delay relay	•	•	•	-	-	•
Passive input with Ex version	-	-	-	-	-	-
Modify HART address of the connected sensors	•	•	•	•	•	•
Activate/deactivate measurement loop	-	-	-	•	•	•

³⁾ Operating Panel (integrated display and adjustment unit)

⁴⁾ only with VEGAMET 391

Instrument version with interface option

Application/Function	391	624	625	693	OP	DTM
Set the time	•	•	•	•	•	•
Assign/modify IP-addr./Subnet mask/Gateway addr.	•	•	•	•	•	•
Assign/modify DNS server addr.	•	•	•	•	-	•
Parameter adjustment of PC/DCS output	•	•	•	•	-	•
VEGA Inventory System settings	•	•	•	•	-	•
Device trend	•	•	•	•	-	•
Configure transmission of measured values via e-mail	•	•	•	•	-	•
Configure transmission of measured values via SMS	•	•	•	•	-	•

12.3 Dimensions

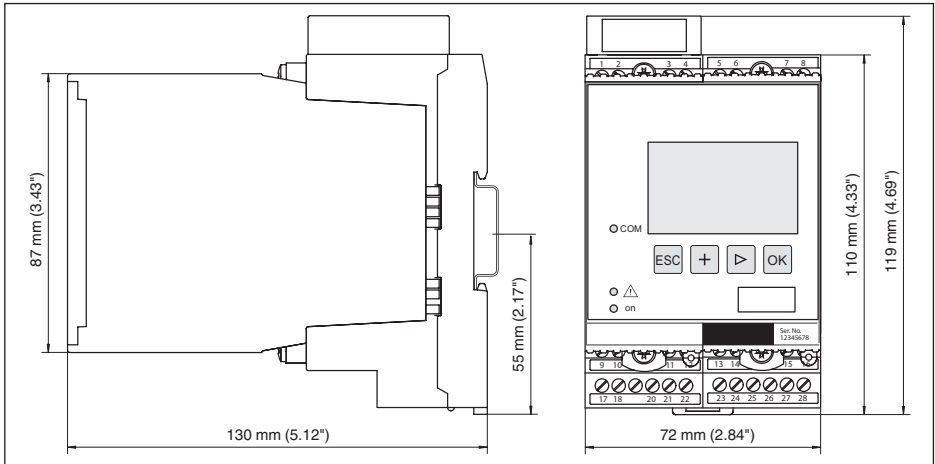

12.4 Industrial property rights

VEGA product lines are global protected by industrial property rights. Further information see www.vega.com.

VEGA Produktfamilien sind weltweit geschützt durch gewerbliche Schutzrechte.

Nähere Informationen unter www.vega.com.

Les lignes de produits VEGA sont globalement protégées par des droits de propriété intellectuelle. Pour plus d'informations, on pourra se référer au site www.vega.com.

VEGA líneas de productos están protegidas por los derechos en el campo de la propiedad industrial. Para mayor información revise la pagina web www.vega.com.

Линии продукции фирмы ВЕГА защищаются по всему миру правами на интеллектуальную собственность. Дальнейшую информацию смотрите на сайте www.vega.com.

VEGA系列产品在全球享有知识产权保护。

进一步信息请参见网站 < www.vega.com。

12.5 Trademark

All the brands as well as trade and company names used are property of their lawful proprietor/originator.

INDEX

A

Access protection 26, 27
 Address setting 13, 17
 Adjustment 8, 21, 39, 52
 – Max. adjustment 22
 – Min. adjustment 21
 Application 18
 Application area 8
 ASCII protocol 40

C

Cable
 – Grounding 12
 – Potential equalisation 12
 – Shielding 12
 Carrier rail mounting 10
 Causes of malfunction 51
 Current output 24
 Cylindrical tank 23

D

Damping 22
 Date of manufacture 28
 Date setting 20
 Default setting 25
 Device info 28
 Device-TAG 19
 DHCP 17, 37
 Diagnostics 25
 Differential measuring point 21, 42
 Display
 – Language adjustment 26
 Displayed value 25
 Documentation 7
 Dry run protection 23, 41
 DTM 9, 17, 24, 40
 – DTM Collection 39
 – Full version 40

E

E-mail 37, 40
 Ethernet 37, 40
 Ethernet interface 27

F

Fault 24
 – Fault message 25, 52
 – Rectification 51
 Flow measurement 24, 49
 Fluctuating medium surface 22

Functional principle 8

G

Gateway address 19

H

HART 13, 17, 27
 Horizontal cylindrical tank 41
 Host name 19
 HTML 37
 Hysteresis 42

I

I²C interface 37
 Input
 – Active 12
 – HART 19, 20
 – Passive 12
 Installation possibilities 10
 Instrument coding 10
 Integration time 22
 Interface measurement 21, 44
 IP address 19, 37, 40

L

Language adjustment 26
 Level measurement 41
 Linearisation 23
 Linearisation curve 23, 41
 Lin. percent 25

M

MAC address 28
 Main menu 18
 Meas. loop TAG 23
 Measured value indication 18
 Measured variable 21
 Modbus-TCP 40
 Modem 38
 Mounting 10
 Multidrop 17, 27
 Multiviewer 40

N

Network 17

O

Online help 28, 40
 Operating instructions 8
 Overflow protection 23, 41

P

PACTware 9, 17, 24
Parameter adjustment 17
PIN 26, 27
Potential equalisation 12
Primary Value 21
Pump control 45

Q

QR code 7

R

Relay 53
Relay output 23
– Fail safe relay 52
Remote access 27
Repair 53
Reset 25
RS232 38
– Communication protocol 20
– Connection assignment RS232 modem
connection cable 39
– USB - RS232 adapter 38
RS232 interface 27

S

Scaling 23, 25, 41, 52
Screen control 42
Secondary Value 21
Sensor address 27
Sensor input
– Active 12
– Passive 12
Sensor search 20
Serial number 7, 8, 28
Service 25
Service hotline 51
Simulation 25
Software update 39
Spherical tank 23
Subnet mask 19
Switching window 24

T

Tank calculation 40
Tendency 24
Tendency recognition 47
Time setting 20
Type label 7, 8

U

USB
– USB - RS232 adapter 38

V

VEGA Inventory System 27
VEGA Tools app 8
Visualization 37

W

Web server 40



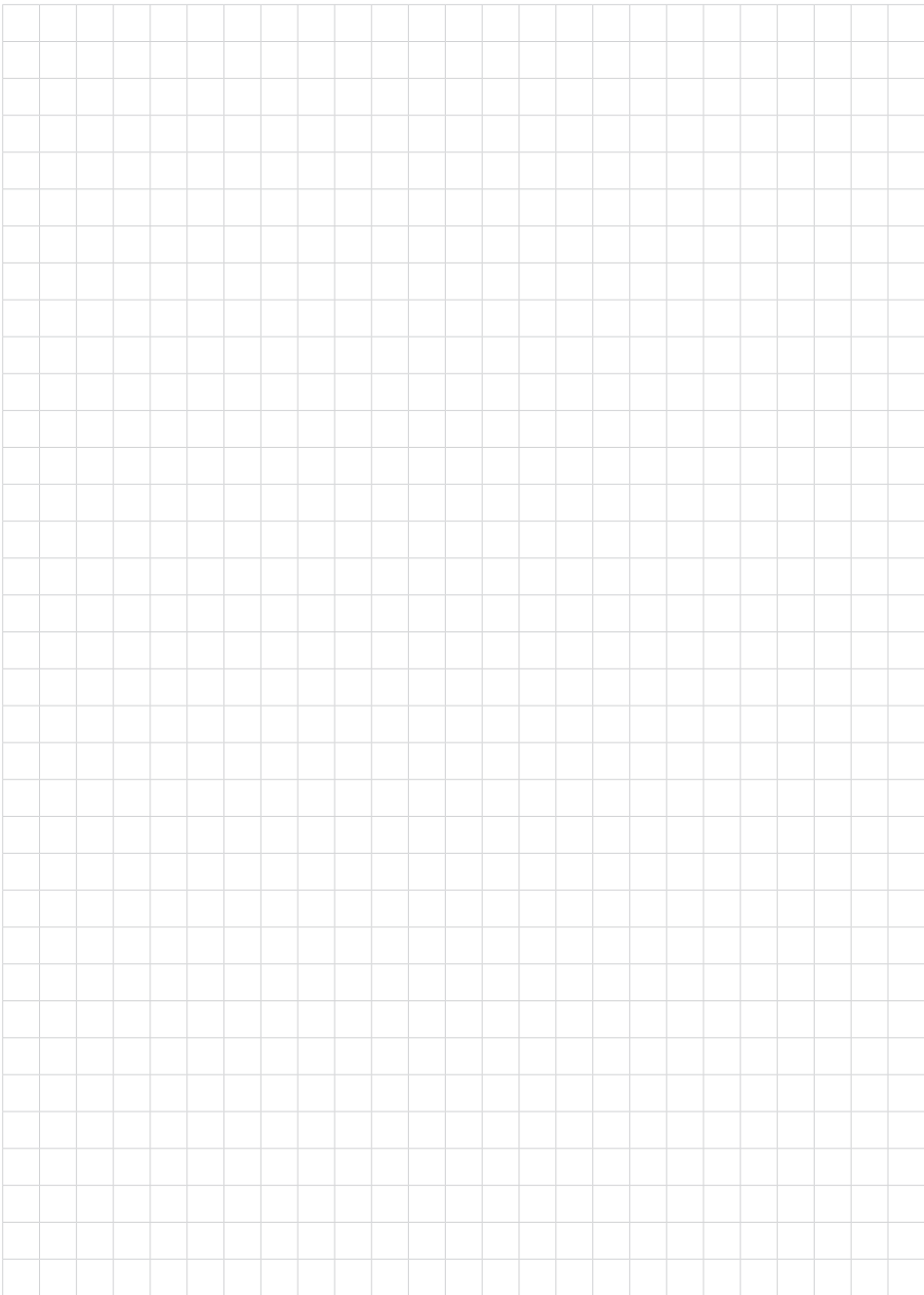

28970-EN-210818

Printing date:

VEGA

All statements concerning scope of delivery, application, practical use and operating conditions of the sensors and processing systems correspond to the information available at the time of printing.

Subject to change without prior notice

© VEGA Grieshaber KG, Schiltach/Germany 2021



28970-EN-210818

VEGA Grieshaber KG
Am Hohenstein 113
77761 Schiltach
Germany

Phone +49 7836 50-0
E-mail: info.de@vega.com
www.vega.com