



Freedom at Your Fingertips

Water Purification Product Catalog



ENGINEERING YOUR SUCCESS.

Parker Water Purification is Certified by the Following Associations:

ABS Type Approved ISO 9001:2015 by ABS.

Safety, service, and solutions are the goals that define the American Bureau of Shipping. Parker Water Purification is the first and only watermaker manufacturer to gain full product line type acceptance.

National Marine Manufacturers Association and Southern California Marine Association.

Parker Water Purification is an active member in the above associations in good standing.
CE Approval

The Conformité Européenne (CE) mark indicates that our products comply with the legal standards of the EU directives.



This is Parker

Addressing the needs of humanity by providing clean water.

For decades, Village Marine (VMT) has developed advanced water desalination and purification systems for some of the most challenging environments – the middle of the ocean, 800 feet below the sea, offshore oil rigs, deserts, and disaster areas. For over 30 years Sea Recovery (SRC) & Horizon Reverse Osmosis (HRO) have manufactured ingenious and intuitive watermakers. In 2012, Parker combined the 3 companies and Parker Water Purification (WP) was established.

The superior quality components that go into Parker WP systems ensure that each one is built to the highest standards of safety, maintainability, and reliability. High grades of raw materials are precisely machined & thoroughly tested to exact customer requirements and industry specifications.

Parker WP provides state-of-the-art and reliable reverse osmosis (RO) purification systems for seawater, brackish water, and tap water; from energy-saving 145 GPD watermakers to high-performance 250,000 GPD systems has established Parker WP as a leader in the watermaking brand among marine consumers and boat builders around the world. The U.S. Navy, the U.S. Coast Guard, the U.S. Army, NASA, FEMA, seaside properties such as Catalina Island, and disaster relief project such as Hurricane Katrina and Hurricane Dorian, have relied on Parker WP for high-profile projects.

This is Parker addressing the needs of humanity by providing clean water.

Table of Contents

LWM	6	SRC Commercial Series	
LTM	8	Coral Sea	32
H2O ECO	10	Tasman Sea.....	34
ProMini	12	North Sea.....	35
Aqua Whisper Pro	14	Atlantic Sea	38
Seafari Versatile	16	VMT Commercial Series	
Aqua Matic	18	LT Watermakers	40
Aqua Matic XL	20	Commercial Pure Water Series	42
Aqua Matic Dual Pass ^{v2}	22	Offshore Desalinators SW Series.....	44
Aqua² Duo	24	Bilgewater Absorbent Separator.....	46
ULTRO Clear DF	26	Maintenance Kit	48
Pure Water Series	28		
H2O Pro	30		

Parker Water Purification

The Trusted Source for Fresh Water

Parker Water Purification has manufactured the most innovative and intuitive watermakers for the past 30 years. By incorporating a customer-first philosophy into our designs, the quality of our products is never compromised. We believe that boaters deserve more from their watermakers. Dealing with confusing controls and maintenance should not

be a concern. Our company strives to communicate to the heart of the leisure boater, by engineering systems that marries style with functionality, a formula that has made Parker Water Purification the #1 watermaking brand among marine consumers and boat builders around the world.

Service and Support

Worldwide Dealer Network

With hundreds of certified dealers throughout the world, Parker Water Purification customers can cruise confidently to any destination and expect a friendly Parker Water Purification expert ready to service or upgrade their system.

Parker Water Purification Warranty Coverage*

We stand behind our innovative products by providing our customers a full year warranty that includes full coverage for parts and labor at no extra cost to you.

Quality is our Priority

Safety and quality standards are priority and our goal is to surpass them. Our products utilize quality parts and are built to withstand any condition.

*Refer to your owner's manual for warranty details.

Enjoy the Benefits of a Parker Water Purification Watermaker

Less weight, lower fuel costs, higher speeds

Cruising with a full water tank, or an extra 1,700 pounds will result in wasted fuel, slower speeds, and shorter trips. A Parker Water Purification watermaker allows you to cruise faster and farther and create fresh water... on location. Our systems save boaters time and money, while maximizing yacht performance.

Cruise without limits or boundaries

With a Parker Water Purification watermaker, you don't need to plan your boating activities around marina stops. Cruise direct to your destination or cruise to limitless distances without the need to stock up on fresh water.

Fresh water wash downs

Wash downs with Parker Water Purification water are highly effective in preserving your yacht's exterior, which can contribute to an increase to the value of your yacht. Parker Water Purification water acts as a sponge, absorbing and washing out all unwanted sea salt and minerals, and dries clean - without any water spots.

Convenient for every boating activity

Whether you use it to drink, shower or to wash down your yacht, owning a Parker Water Purification watermaker provides unlimited possibilities that saves money and increases leisure time. How can any boater afford not to own a Parker Water Purification watermaker?

Did You Know?



You can increase the value of your boat up to 10% by washing down your boat with Parker Water Purification product water.



Parker Water Purification water has superior taste than your regular tap. Even coffee made with Parker Water Purification water tastes better.



You can create clear ice cubes with Parker Water Purification water. Store any food, including fish of the day with Parker Water Purification water ice for better preservation.

State of the Art Color Touch Screen

User-friendly touchscreen

Our full color LCD touch screens are designed to be simple and easy to use. Featuring an intuitive Human Machine Interface navigation menu, system start-up and controls are able to be activated with a single touch.

Customized display settings

Equipped with a multiple language interface, you can choose to display your screen in English, French, Italian, and Spanish. You also have the choice to set measurement units to either metric or US standard readings.

Quality Tested for Smooth Functionality

Engineered for less noise pollution

Parker Water Purification watermakers feature state of the art frames that optimize space, minimize sound, and reduce maintenance time. Sound has been noticeably reduced by 3db for the Aqua Matic and Aqua Whisper DX systems.



Vibration tested

Our systems are manufactured and tested to withstand up to 20 G's of continuous force for over an hour of operation, ensuring reliable performance in all conditions.

More Water, Less Clutter

Parker Water Purification watermakers create more water per square inch than any other system in the world. By utilizing high efficiency membranes, there is 17% more filtering surface area than conventional membranes. This reduces the amount of membranes and installation space required by competing brands.

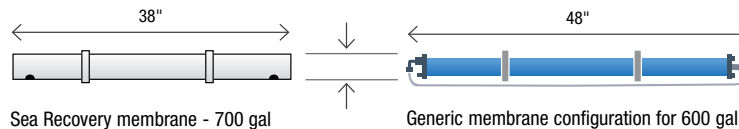
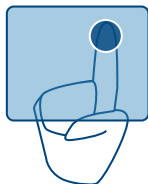

Ex. 1: Parker Water Purification's 700 gallon capacity membranes are smaller in length, about the same in diameter, yet have a larger filtering surface than the generic 600 gallon membrane.

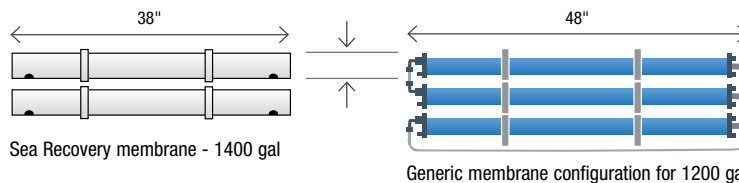

Ex 2: Parker Water Purification's 1400 gallon membrane configuration uses less membranes than the generic 1200 gallon membrane configuration, giving you more filtering surface while reducing replacement and maintenance costs.

Modus / NMEA 2000 - No More Engine Room Visits

Parker Water Purification's new line of watermakers are Modus and NMEA 2000 compliant, giving boaters the power to monitor and communicate with their systems through any Modus and NMEA 2000 compatible display.*

NMEA 2000 Network

Eliminate wires, clutter, and engine room visits by connecting directly to your NMEA 2000 central connection. This network standard allows boaters to monitor all NMEA-compliant electronics through their system displays installed throughout your yacht or laptop.



Tower Display

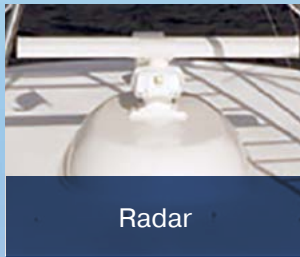

Radar



Aqua Matic Remote Display



Flybridge and GPS Display

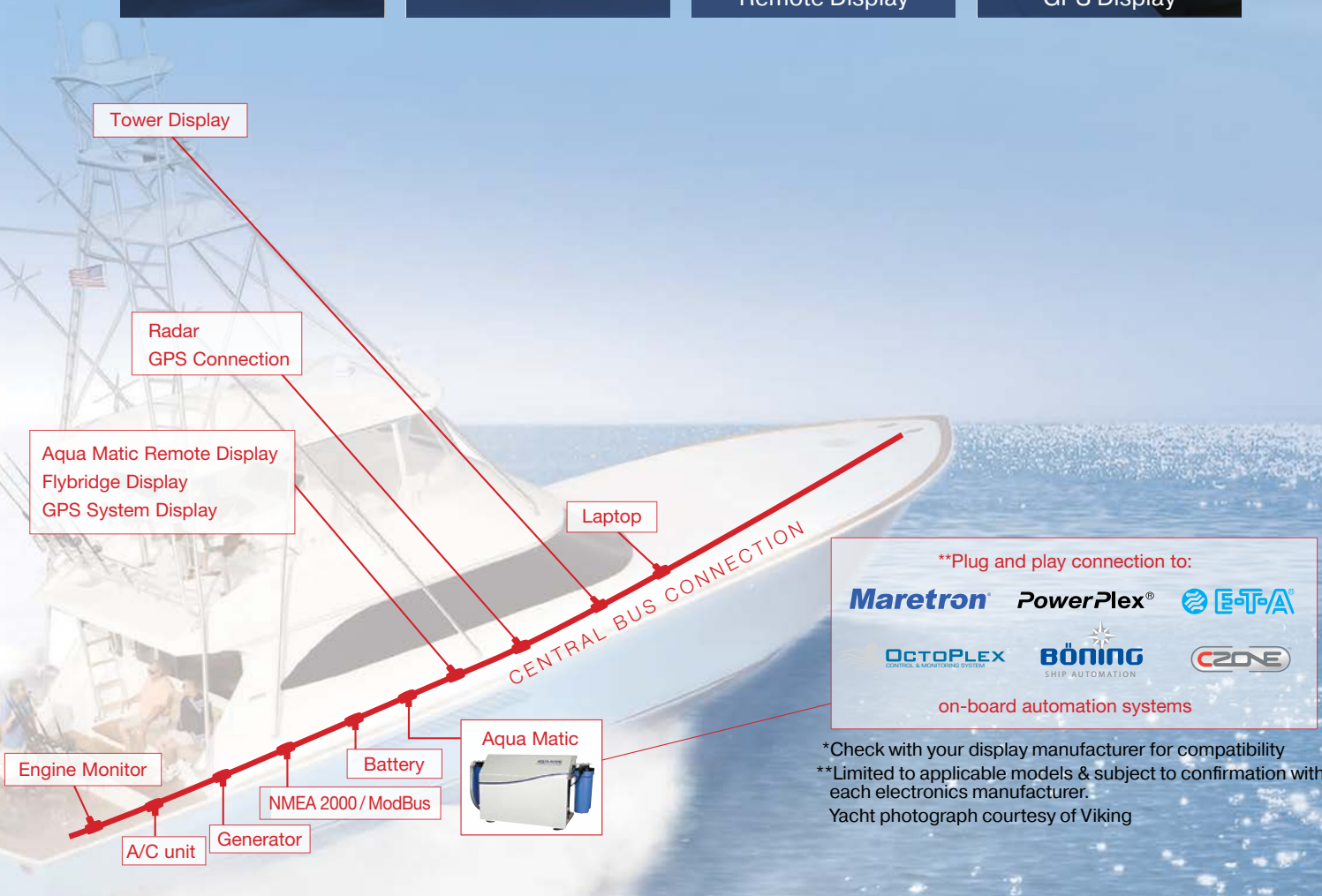

⚠ WARNING: This product can expose you to chemicals including Di(2-ethylhexyl) phthalate (DEHP), which is known to the state of California to cause cancer and birth defects or other reproductive harm. For more information go to www.P65Warnings.ca.gov.

LWM Series Modular Watermarker

145-180 GPD – 530-681 LPD



Features & Benefits

- Available for 12V, 24V power supplies as shown.
- 5 micron cleanable prefilter.
- Powder coated mounting brackets included.
- Control manifold pressure regulator ensures consistent pressure and prevents over or under pressurization of the unit. Adjustable to allow operation in brackish or fresh water.
- Acrylic flowmeter to monitor production.
- High quality spiral wound TFC reverse osmosis membranes.
- Magnetic drive boost pump.
- Stainless steel glycerin filled pressure gauges.
- High pressure pump impervious to the corrosive sea water environment and designed for maximum efficiency.



Specifications

Model	Part Number	Electrical Supply Voltage-DC / Amps	Capacity GPH / LPH	Weight lbs / kg
LWM-145	90-8200 90-8622	12 / 15 2 / 7.5	6/23	150/68
LWM-180	90-8512 90-8596	12/ 22 24/ 11	7.5/28.4	225/102

⚠ WARNING: This product can expose you to chemicals including Di(2-ethylhexyl) phthalate (DEHP), which is known to the state of California to cause cancer and birth defects or other reproductive harm. For more information go to www.P65Warnings.ca.gov.

Spares and Consumables

Part	Description
85-0050	Pump Oil
33-0117	5 Micron Filter
33-0311	Carbon Flush Filter
33-3000	Membrane Element LWM 145
33-3001	Membrane Element LWM 180**
33-3038	Membrane Element LWM 145***
90-0005	Filter Housing O-Ring
99-6881	Filter Wrench
70-6181	HP Pump Service Kit

Part	Description
90-2512	Membrane O-Ring Kit
40-0241	Salinity Probe
85-0102	Cleaning Kit
85-0103	Preservation Kit
70-6181	Kit, Pump, Routine Service
99-1990A	Digital Handheld TDS Meter
70-0036	Belt, Models 145
70-0168	Belt, Models 200

**All system requires 2 x 33-3001 per system

***This used for spares only single 40" vessel.

Recommended Options - LTM 145-300 12/24 VDC System

Part Number	Description
90-1288	Manual Fresh Flush, Assembly
61012118	Kit, Installation, 145-500 GPD
V016020001	Booster Pump/Motor 12VDC
V016020002	Booster Pump/Motor 24VDC
61012116	Sea Strainer, 40 Mesh, Assembly

Dimensions

System Manifold

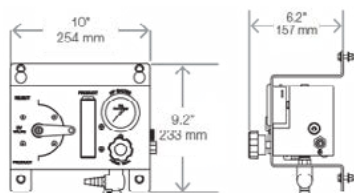

Membrane Assembly

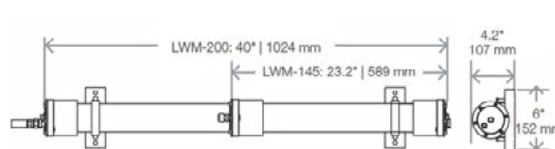

Fresh Water Flush

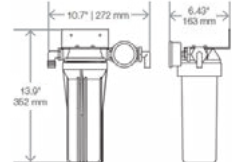

Booster Pump

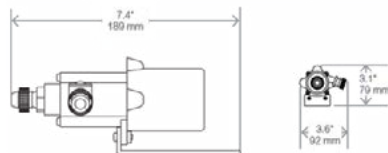

High Pressure Pump

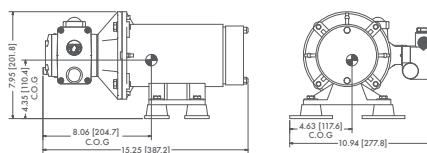

Pre-Filter

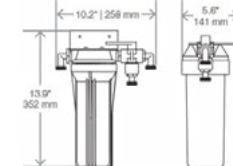

To maintain peak performance, always use genuine Parker Village Marine replacement parts. We reserve the right to change our specifications or standards without notice.

WARNING: This product can expose you to chemicals including Di(2-ethylhexyl) phthalate (DEHP), which is known to the state of California to cause cancer and birth defects or other reproductive harm. For more information go to www.P65Warnings.ca.gov.

LTM Series Modular Watermarkers

145-1,800 GPD – 530-6,800 LPD

Features & Benefits

- Powder coated mounting brackets included.
- 5 micron cleanable prefilter.
- Control manifold pressure regulator ensures consistent pressure and prevents over or under pressurization of the unit. Adjustable to allow operation in brackish or fresh water.
- Magnetic drive boost pump.
- High quality spiral wound TFC reverse osmosis membranes.
- Stainless steel glycerin filled pressure gauges.
- High pressure plunger pump with stainless steel 316 head.



Specifications

Model	Part Number	Electrical Supply Volts / Ph / Hz / Amps	Capacity GPH / LPH	Weight lbs / kg
LTM-145	90-8200PH	12/29	6/23	92/42
	90-8622PH	24/14.5		
LTM-300	90-8154PH	12/34	12.5/47.3	92/42
	90-8596PH	24/7		
LTM-350	90-6009	12 VDC/60	14.6/55	92/42
	90-6010	24 VDC/30		
LTM-500	90-6019	110/1/60/18	21/79	92/42
	90-6047	220/1/60/8		
	90-6048	230/1/50/8		
LTM-800	90-6049	110/1/60/18	33/125	100/45
	90-6050	220/1/60/9		
	90-6051	230/1/50/8		
	90-6079	230-460/3/50-60/6-4		
LTM-1000	90-6052	220/1/60/12**	42/158	133/60
	90-6053	230/1/50/12.5		
	90-6080	230-460/3/50-60/8-6.5		
LTM-1300	90-6054	220/1/60/12**	54/205	153/70
	90-6055	230/1/50/12.5		
	90-6082	230/460/3/50-60/8.6.5		
LTM-1800	90-6083	110/1/50-60/18	75/284	168/76
	90-6058	220/1/60/12		
	90-6078	230/1/50		
	90-6076	380/3/50/7.5		
	90-6077	460/3/60/7		

*Membrane elements are sold separately.

**For 110/50/60/1 please inquire with factory.

⚠ WARNING: This product can expose you to chemicals including Di(2-ethylhexyl) phthalate (DEHP), which is known to the state of California to cause cancer and birth defects or other reproductive harm. For more information go to www.P65Warnings.ca.gov.

For Sail Boat and Fishing Vessel Applications

The LTM Series offers high quality Parker Village Marine engineered components with straightforward manual operation. Driven by AC motors, the modular configuration comes in ready to mount modules for

flexible installation options. Integral to every LTM unit is a control manifold, which includes a regulator and a bypass valve.

Key Feature

Optional salinity monitor and diversion valve system for water quality assurance.

Salinity monitor and diversion valve

- P/N 90-0115 110V 500-800 GPD
- P/N 90-0116 220V 500-800 GPD
- P/N 90-0127 220V 1300-1800 GPD



Spares and Consumables

Part	Description
85-0050	Pump Oil
33-0117	5 Micron Filter (up to model 800)
33-0052	5 Micron Filter (model 1000 and up)
33-0311	Carbon Flush Filter
33-0238	Membrane Element
85-0103	Preservation Kit
90-0005	Filter Housing O-Ring (up to model 800)
33-0271	Filter Housing O-Ring (model 1000 and up)
90-2512	Membrane O-Ring Kit
40-0241	Salinity Probe
85-0102	Cleaning Kit

Recommended Options - LTM 145-300 12.24 VDC System

Part Number	Description
90-1288	Manual Fresh Flush, Assembly
61012118	Kit, Installation, 145-500 GPD
V016020001	Booster Pump/Motor 12VDC
V016020001	Booster Pump/Motor 24VDC
61012116	Sea Strainer, 40 Mesh, Assembly

Optional Accessories

Part Number	Description	System Capacity (GPD/LPH)	System Voltage Voltage/Hz/Phase
90-0215	Manual Fresh Flush, Assembly	All	All
61012010	Kit, Installation, 300-1800 GPD	All	All
V006060001	Sea Strainer, 40 Mesh, Assembly	300-500/47.3-79	All
0421056739	Sea Strainer 3/4 Bronze	800-1800/125-284	All
B016380002	Booster Pump/Motor 12VDC	300-47.3	12VDC
B016380003	Booster Pump/Motor 24VDC	300-47.3	24VDC
V016030001	Booster Pump 110/220V, 1PH, Assy	500/79	110-220/1/50/60/1
B016080026	Booster Pump Assembly 110/230/50/80/1P	800-1800/125-284	110-230/50/60/1
B016080027	Booster Pump Assembly 208-460/50/60/3P	800-1800/125-284	208-460/50/60/1

System Manifold

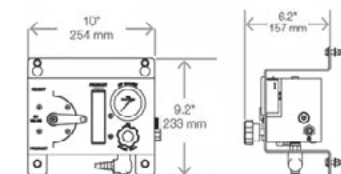

Membrane Assembly

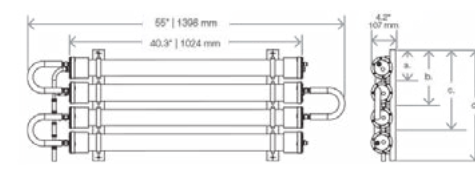

Fresh Water Flush

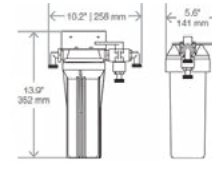

Booster Pump

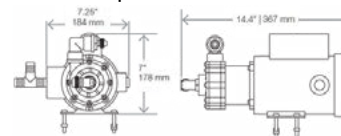

High Pressure Pump

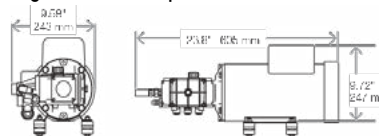

Pre-Filter

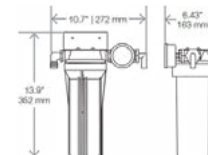

To maintain peak performance, always use genuine Parker Village Marine replacement parts. We reserve the right to change our specifications or standards without notice.

WARNING: This product can expose you to chemicals including Di(2-ethylhexyl) phthalate (DEHP), which is known to the state of California to cause cancer and birth defects or other reproductive harm. For more information go to www.P65Warnings.ca.gov.

H2O ECO The Revolutionary Energy Recovery Watermark

17-25 Gal/Hour – 63-95 Lit/Hour



Features & Benefits

- Energy Recovery Device - Recovers up to 14.5% of power on all models
- AC and DC Models Available
- Fully Automatic Operation
- Compact Configuration
- Manual Fresh Water Flush
- External Booster Pump



Specifications

Part Number	Voltage (DC/AC)	Capacity (GPD)	LPH	DC Power (Watts)	AC (NOA)	Weight
A012C-111	12	400	63	240		120lbs / 54kg
A012C-121	24	400	63	240		120lbs / 54kg
A012C-211	12	600	95	437		125lbs / 57kg
A012C-221	24	600	95	437		125lbs / 57kg
A012C-311	110/50 - 60/1	400	63		5.8	120lbs / 54kg
A012C-321	220/50 - 60/1	400	63		2.9	120lbs / 54kg
A012C-411	110/50 - 60/1	600	95		9	125lbs / 57kg
A012C-421	220/50 - 60/1	600	95		4.5	125lbs / 57kg

NOA = Normal Operation Amps

WARNING: This product can expose you to chemicals including Di(2-ethylhexyl) phthalate (DEHP), which is known to the state of California to cause cancer and birth defects or other reproductive harm. For more information go to www.P65Warnings.ca.gov.

The Low Power Consumption Choice

The new Patent Pending Energy Recovery Device H2O ECO is engineered for boaters with limited power options. Featuring automatic operation, it is ideal for Catamarans and sail boats.

Key Features:

- Compact robust design
- Smooth operation
- Small footprint

Optional Accessories

- B561080001 pH Neutralizer
- B611000004 Remote Control
- B521220002 Charcoal Filter
- B5262000CV UV Sterilizer
- 61012116 External Strainer
- B598000008 Automatic Fresh Water Flush
- 61012124 Installation Kit

Duration Maintenance Kits

Product Family	Initial Load Out	3 Months (200 hrs.)	6 Months (500 hrs.)	12 Months (1000 hrs.)	24 Months (2000 hrs.)
H2O ECO (Standard Prefilters)	61012096	61012097	61012098	61012099	61012100

Dimensions

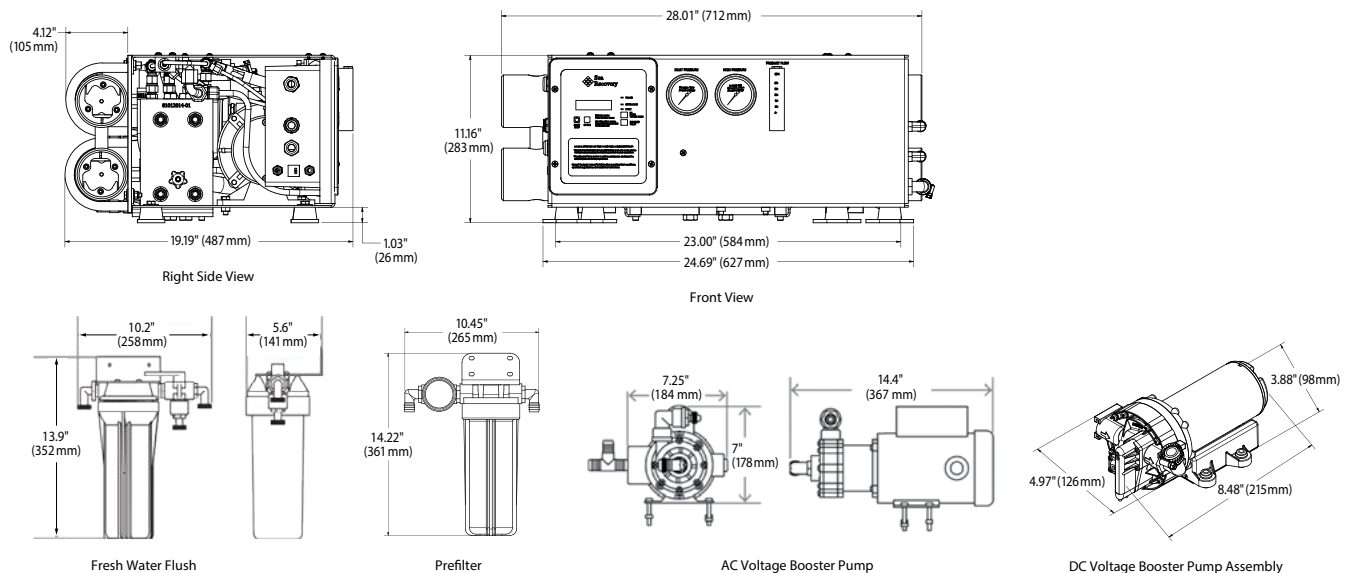

To maintain peak performance, always use genuine Parker Village Marine replacement parts. We reserve the right to change our specifications or standards without notice.

⚠ WARNING: This product can expose you to chemicals including Di(2-ethylhexyl) phthalate (DEHP), which is known to the state of California to cause cancer and birth defects or other reproductive harm. For more information go to www.P65Warnings.ca.gov.

PRO Mini

Small Power Boats and Sailboats
(35-45 feet / 9-14 meters)



Features & Benefits

- Smallest Line of Watermaker
- Easy Access to Main Components
- Low AC Power Consumption
- Maximum Capacity System Weight Is 150 LBS
- Semi-Automatic Operation
- Automatic Fresh Water Flush

Specifications

Model	Production / Hr.	Production / 24 Hrs.	Weight - Compact	Weight - Modular
PRO Mini 170	7 gal / 27 L	170 gal / 644 L	70 lbs / 32 kg	70 lbs / 32 kg
PRO Mini 350	15 gal / 55 L	350 gal / 1,325 L	127 lbs / 58 kg	89 lbs / 40 kg
PRO Mini 550	23 gal / 87 L	550 gal / 2,080 L	142 lbs / 64 kg	128 lbs / 57 kg
PRO Mini 750	31 gal / 117 L	750 gal / 2,839 L	150 lbs / 68 kg	130 lbs / 59 kg

Electrical Motor Specifications

PRO MINI 170

Electrical	Phase	Pump Motor	Voltage	Hz	H.P.	Running Amps	Start Up Amps
Mini 170	N/A	HP	12 / 24	N/A	0.33	27/13.4	90/45
Mini 170	Single	HP	110 / 230	50 // 60	0.33	6.6/3.3//5.2/2.6	26/13
Mini 350	Single	HP	110 / 230	60	1	12.8/6.4	39/20
Mini 350	Single	HP	110 / 230	50	1	12.4/6.2	37/19
Mini 550 / 750	Single	HP	110/220//115/230	50/60	1.75//2.1	18.9/9.4//18.2/9.1	57/28
Mini 350/550/750	Single	Booster	110 / 220	50/60	0.5	9.4/4.7-7.4/3.7	28/14

WARNING: This product can expose you to chemicals including Di(2-ethylhexyl) phthalate (DEHP), which is known to the state of California to cause cancer and birth defects or other reproductive harm. For more information go to www.P65Warnings.ca.gov.

Great Things Come in Small Packages

Production Capacity:

170, 350, 550, and 750 Gallons/Day

The low-hassle Pro Mini is engineered to fit anywhere. Measuring about 2 - 3 cubic feet, sail and small power boaters have the opportunity and the convenience of a Sea Recovery watermaker without space restrictions. Featuring a simple interface, the Pro Mini can be monitored via the control panel or remote (optional). The Pro Mini can produce up to 7, 15, 23, or 31 gallons of fresh water per hour and is the perfect seaworthy companion for the solo cruiser.

Dimensions

COMPACT 170, 350, 550, and 750

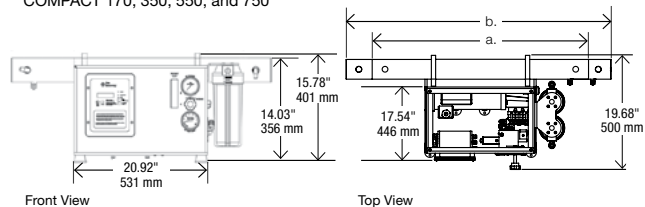

a. PRO Mini 350 & 550: 37.94" / 964 mm | b. PRO Mini 750: 46.94" / 1192 mm

PRO Mini 170

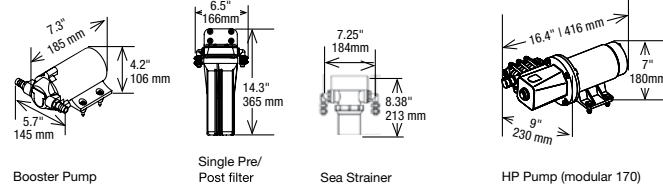

PRO Mini 350-750

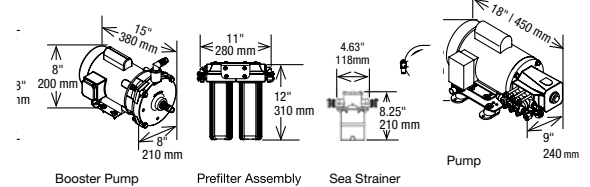

MODULAR 170, 350, 550 and 750

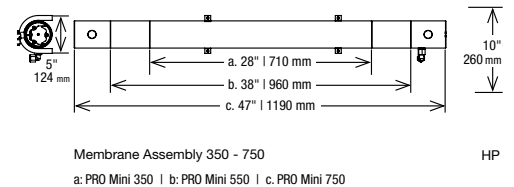
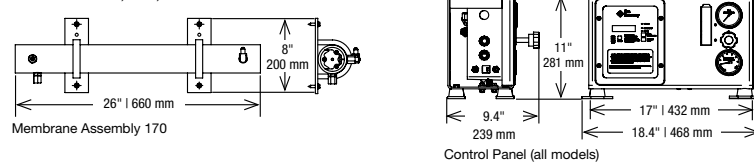

To maintain peak performance, always use genuine Parker Village Marine replacement parts. We reserve the right to change our specifications or standards without notice.

WARNING: This product can expose you to chemicals including Di(2-ethylhexyl) phthalate (DEHP), which is known to the state of California to cause cancer and birth defects or other reproductive harm. For more information go to www.P65Warnings.ca.gov.

Aqua Whisper Pro

Mid to Large Yachts
(40-80 ft / 12-24 m)



Features & Benefits

- Automatic FWF on frame.
- Automatic shutdown option.
- Robust, fail-safe design.

Specifications

	Model #	Production / Hr.	Production / 24 hrs.	AW PRO compact*	AW PRO modular*
Production & Weight	450-1	19 Gal / 71 L	450 Gal / 1,703 L	157 lbs / 71 kg	157 lbs / 71 kg
	700-1	29 Gal / 110 L	700 Gal / 2,650 L	160 lbs / 73 kg	160 lbs / 73 kg
	900-1	38 Gal / 142 L	900 Gal / 3,407 L	162 lbs / 73 kg	162 lbs / 73 kg
	900-2	38 Gal / 142 L	900 Gal / 3,407 L	169 lbs / 77 kg	169 lbs / 77 kg
	1400-2	58 Gal / 221 L	1,400 Gal / 5,300 L	175 lbs / 79 kg	175 lbs / 79 kg
	1800-2	75 Gal / 284 L	1,800 Gal / 6,814 L	180 lbs / 82 kg	180 lbs / 82 kg

*Weights based on single phase motor. For three phase motors subtract 9 lbs.

Electrical

	Phase	Pump Motor	Voltage VAC	Hz	NOA	SUC	Operating Voltage	Recommended Circuit Breaker
Plunger Pump	Single	HP / Booster	110-115 / 220 -230	50 / 60	110 / 220 30 / 15	110 / 220 100 / 50	110-115 / 220-230	40 Ampere / 20 Ampere
	Three	HP / Booster	220-230 / 380-460	50 / 60	110 / 220 11 / 5.5	110 / 220 30 / 15	220 / 380 / 460	15 Ampere / 10 Ampere / 10 Ampere

*Production may vary +/-20% | GPD: Gallons per day • LPD: Liters per day

⚠ WARNING: This product can expose you to chemicals including Di(2-ethylhexyl) phthalate (DEHP), which is known to the state of California to cause cancer and birth defects or other reproductive harm. For more information go to www.P65Warnings.ca.gov.

For the Hands-On Boater

The Aqua Whisper Pro watermaker is suited for charter, offshore fishing, and ocean cruising. Its traditional manual functions and touch-pad control panel allows simple operation and digital + analog instrumentation for redundancy. The Aqua Whisper Pro's high pressure pump is engineered to be quieter than conventional high pressure pumps, and operates for 2,500 hours before any maintenance is required.

Dimensions

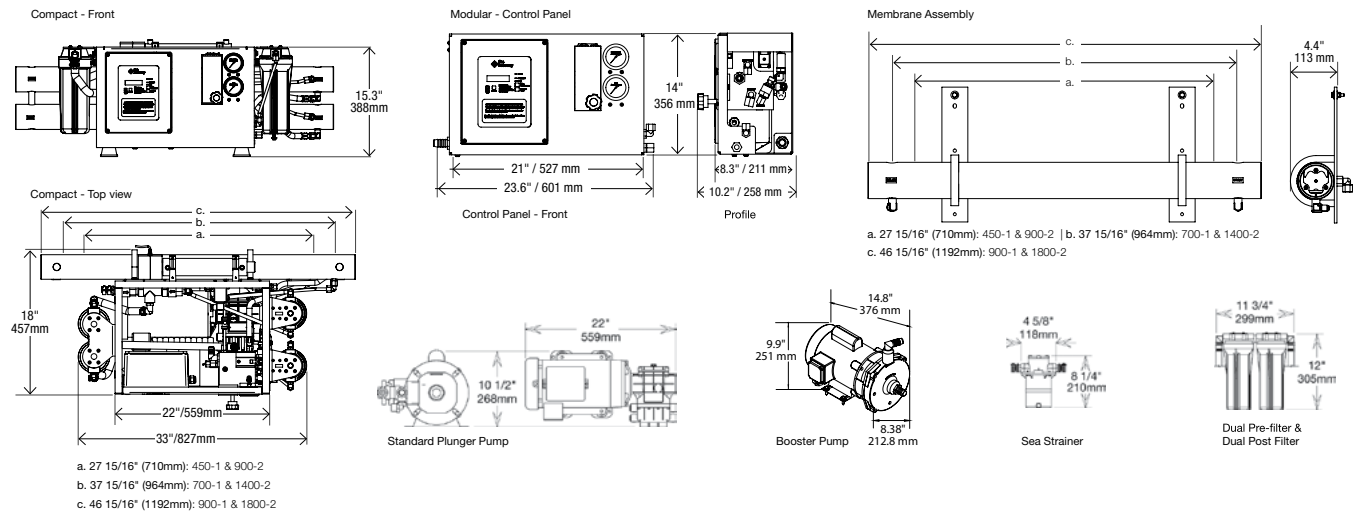

To maintain peak performance, always use genuine Parker Village Marine replacement parts. We reserve the right to change our specifications or standards without notice.

⚠ WARNING: This product can expose you to chemicals including Di(2-ethylhexyl) phthalate (DEHP), which is known to the state of California to cause cancer and birth defects or other reproductive harm. For more information go to www.P65Warnings.ca.gov.

Seafari Versatile

450-1800 Gal/Day

1705-6815 Lit/Day



Features & Benefits

- Remote Mount Cube - for easy access to system controls.
- Equipped with a failsafe Product Water Diversion Valve allowing only safe drinking water to enter storage tanks.
- High rejection, high yield, commercial grade, and chemical resistant Membranes.



Specifications

Part Number	Model	Per 24 Hours Gal / Lit	Per Hours Gal / Lit	Weight
H24C/H25M-450	450-1	450 / 1,705	18 / 70	118 lbs / 54 kg
H24C/H25M-700	700-1	700 / 2,650	26 / 110	125 lbs / 57 kg
H24C/H25M-900	900-1	900 / 3,405	38 / 140	136 lbs / 62 kg
H24C/H25M-1400	1400-2	1,400 / 5,300	58 / 220	147 lbs / 67 kg
H24C/H25M-1800	1800-2	1,800 / 6,815	75 / 285	150 lbs / 68 kg

Electrical

	Phase	Pump Motor	Voltage VAC	Hz	NOA	SUC	Operating Voltage	Recommended Circuit Breaker
Plunger Pump	Single	HP / Booster	110-115 / 220-230	50 / 60	110 / 220 30 / 15	110 / 220 100 / 50	110-115 / 220-230	40 Ampere / 20 Ampere
	Three	HP / Booster	220-230 / 380-460	50 / 60	110 / 220 11 / 5.5	110 / 220 30 / 15	220 / 380 / 460	15 Ampere / 10 Ampere / 10 Ampere

*Production may vary +/-20% | GPD: Gallons per day • LPD: Liters per day

WARNING: This product can expose you to chemicals including Di(2-ethylhexyl) phthalate (DEHP), which is known to the state of California to cause cancer and birth defects or other reproductive harm. For more information go to www.P65Warnings.ca.gov.

Space Efficient Design

Along the coast or around the world, the Seafari Versatile is perfect for weekend fishing or blue water cruising. Its user-friendly operating system and rugged build withstands the ocean's harshest conditions, while maintaining its high level of quality.

Dimensions

Self Contained

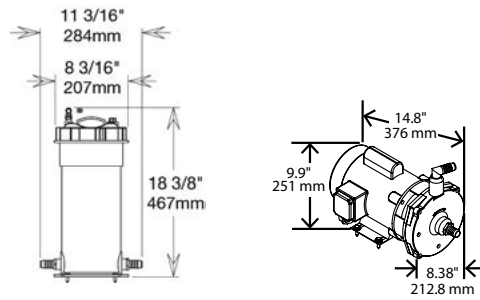
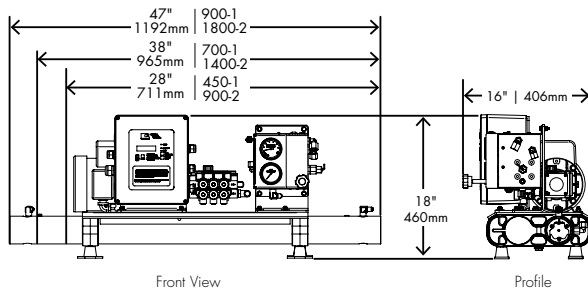

Commercial Pre-Filter & Oil Water Separator

Booster Pump

Modular

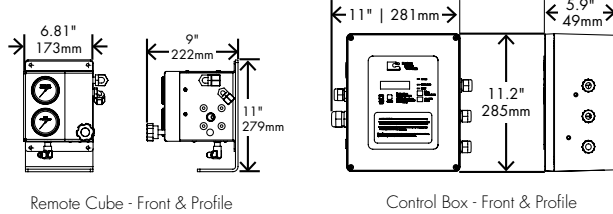

Remote Cube - Front & Profile

Control Box - Front & Profile

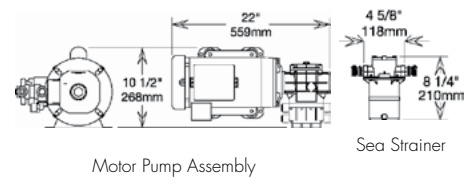

Motor Pump Assembly

Sea Strainer

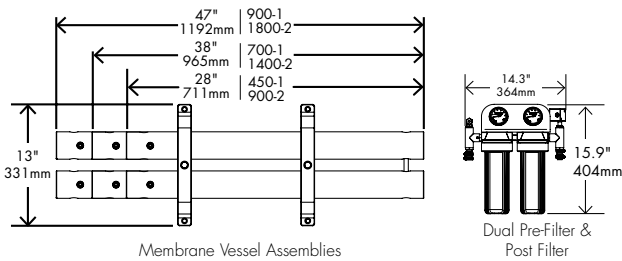

Membrane Vessel Assemblies

Dual Pre-Filter & Post Filter

To maintain peak performance, always use genuine Parker Village Marine replacement parts. We reserve the right to change our specifications or standards without notice.

WARNING: This product can expose you to chemicals including Di(2-ethylhexyl) phthalate (DEHP), which is known to the state of California to cause cancer and birth defects or other reproductive harm. For more information go to www.P65Warnings.ca.gov.

Aqua Matic

Mid to Mega Yachts

(40-over 80 ft / 12-over 24 m)



Features & Benefits

- An automated screen informs the operator of required maintenance.
- Available in a small footprint, compact frame for easy installation.
- Full color, touchscreen remote control.
- Ability to display in multiple languages.

Specifications

	Model #	Production / Hr.	Production / 24 hrs.	AQM Compact*	AQM Modular*
Production & Weight	450-1	19 Gal / 71 L	450 Gal / 1,703 L	153 lbs / 69 kg	149 lbs / 68 kg
	700-1	29 Gal / 110 L	700 Gal / 2,650 L	156 lbs / 71 kg	152 lbs / 69 kg
	900-1	38 Gal / 142 L	900 Gal / 3,407 L	158 lbs / 72 kg	154 lbs / 70 kg
	900-2	38 Gal / 142 L	900 Gal / 3,407 L	165 lbs / 75 kg	161 lbs / 73 kg
	1400-2	58 Gal / 221 L	1,400 Gal / 5,300 L	171 lbs / 76 kg	167 lbs / 76 kg
	1800-2	75 Gal / 284 L	1,800 Gal / 6,814 L	176 lbs / 80 kg	172 lbs / 78 kg

Electrical

	Phase	Pump Motor	Voltage VAC	Hz	NOA	SUC	Operating Voltage	Recommended Circuit Breaker
Plunger Pump	Single	HP / Booster	110-115 / 220 -230	50 / 60	110 / 220 30 / 15	110 / 220 100 / 50	110-115 / 220-230	40 Ampere / 20 Ampere
	Three	HP / Booster	220-230 / 380-460	50 / 60	110 / 220 11 / 5.5	110 / 220 30 / 15	220 / 380 / 460	15 Ampere / 10 Ampere / 10 Ampere

*Production may vary +/-20% | GPD: Gallons per day • LPD: Liters per day

⚠ WARNING: This product can expose you to chemicals including Di(2-ethylhexyl) phthalate (DEHP), which is known to the state of California to cause cancer and birth defects or other reproductive harm. For more information go to www.P65Warnings.ca.gov.

Tomorrow's Technology, Here Today

The Aqua Matic watermaker features automatic operation with a touch-screen control panel that allows simple touch-and-go operations. Product water quality is now displayed in a bar graph format. Regulation and monitor systems function without the need of an operator. Sea Recovery's high-pressure design includes double O-ring seals on duplex stainless steel fittings to ensure leak-proof operation.

Dimensions

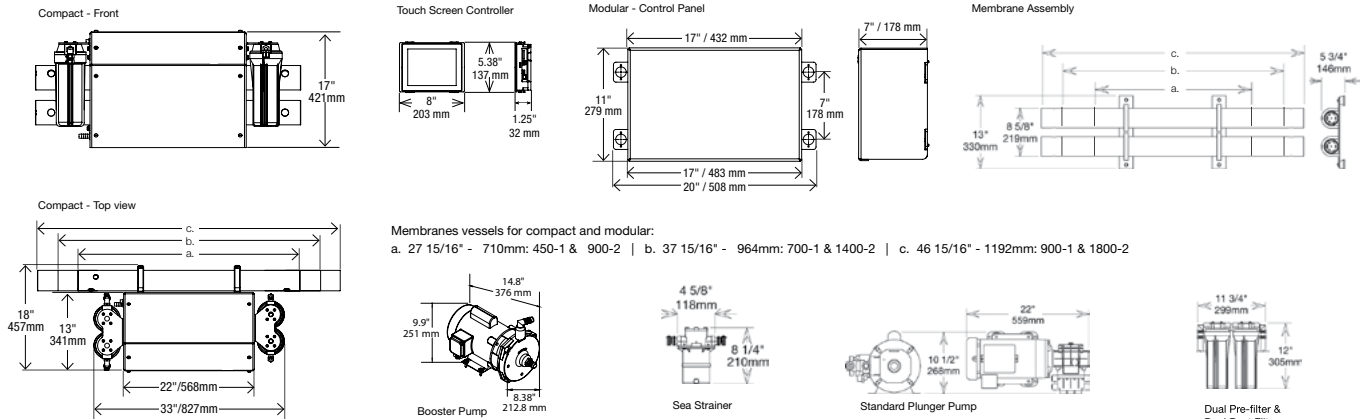

To maintain peak performance, always use genuine Parker Village Marine replacement parts. We reserve the right to change our specifications or standards without notice.

⚠ WARNING: This product can expose you to chemicals including Di(2-ethylhexyl) phthalate (DEHP), which is known to the state of California to cause cancer and birth defects or other reproductive harm. For more information go to www.P65Warnings.ca.gov.

Aqua Matic XL

Large to Mega Yachts
(over 80ft / 24m)



Features & Benefits

- Installation connection & piping (marine vessel installations).
- All system readings can be selected to display either U.S. standard or metric measurements.
- Tank level switches may be installed to control shut down and also prevent start up if the tanks are full.
- All aspects of operation are displayed on straight forward screens providing simple, intuitive information and directions.
- For those who demand simplicity, excellence, automation, elite technology, and low maintenance, the Aqua Matic XL is the only choice.



Specifications

	Model #	Production / Hr.	Production / 24 hrs.	Weight - Compact*	Weight - Modular*
Production & Weight	2200	92 Gal / 347 L	2200 Gal / 8328 L	413 lbs / 187 kg	390 lbs / 176 kg
	2600	108 Gal / 410 L	2600 Gal / 9842 L	413 lbs / 187 kg	400 lbs / 181 kg
	2800	117 Gal / 442 L	2800 Gal / 10599 L	428 lbs / 194 kg	415 lbs / 188 kg
	3400	142 Gal / 536 L	3400 Gal / 12870 L	439 lbs / 199 kg	432 lbs / 196 kg

*Production may vary +/-20% | GPD: Gallons per day • LPD: Liters per day

Electrical

Phase	Booster Pump Motor	Voltage VAC	Hz	Normal Operating Amps	Start Up Current
Three	1.5/2	220/380//230/460	50 / 60	5.2/2.6//5.8/2.9	24/16//27/14
Single	1.5/1	115/230	50 / 60	14.2/7.1//18.2/9.1	54

Circuit Breaker Amp Rating	High Pressure Pump / Motor	AC Voltage	Hz	Phase*	Normal Operating Amps	Circuit Breaker Amp
2200 - 3400 GPD	5 HP	190 / 380	50	3	15.6 / 7.8	80/60
2200 - 3400 GPD	5 HP	208 / 230 / 460	60	3	13.9 / 13.4 / 6.7	80/60
2200 - 3400 GPD	5 HP	230/220	50 / 60	1	21.8//24	80/85

*Production may vary +/-20% | GPD: Gallons per day • LPD: Liters per day

⚠ WARNING: This product can expose you to chemicals including Di(2-ethylhexyl) phthalate (DEHP), which is known to the state of California to cause cancer and birth defects or other reproductive harm. For more information go to www.P65Warnings.ca.gov.

The Simple Things in Life Make the Difference

Robust Engineering and Innovative Design by Sea Recovery's Engineering Team.

Smooth operation and the lowest sound emission in the industry are gained through the design of specific high-pressure pumps ideally matched for flow and pressure characteristics.

Constructed of a lightweight, epoxy-coated frame, both the compact and modular series units utilize only the highest quality marine grade materials and components. Upgrading a model to a higher watermaking capacity is done by simply installing additional reverse osmosis membranes to the desalination system. Unique among watermakers, Sea Recovery delivers complete R.O. systems, ready to produce water immediately after installation. All plumbing for on board use is also included.

Dimensions

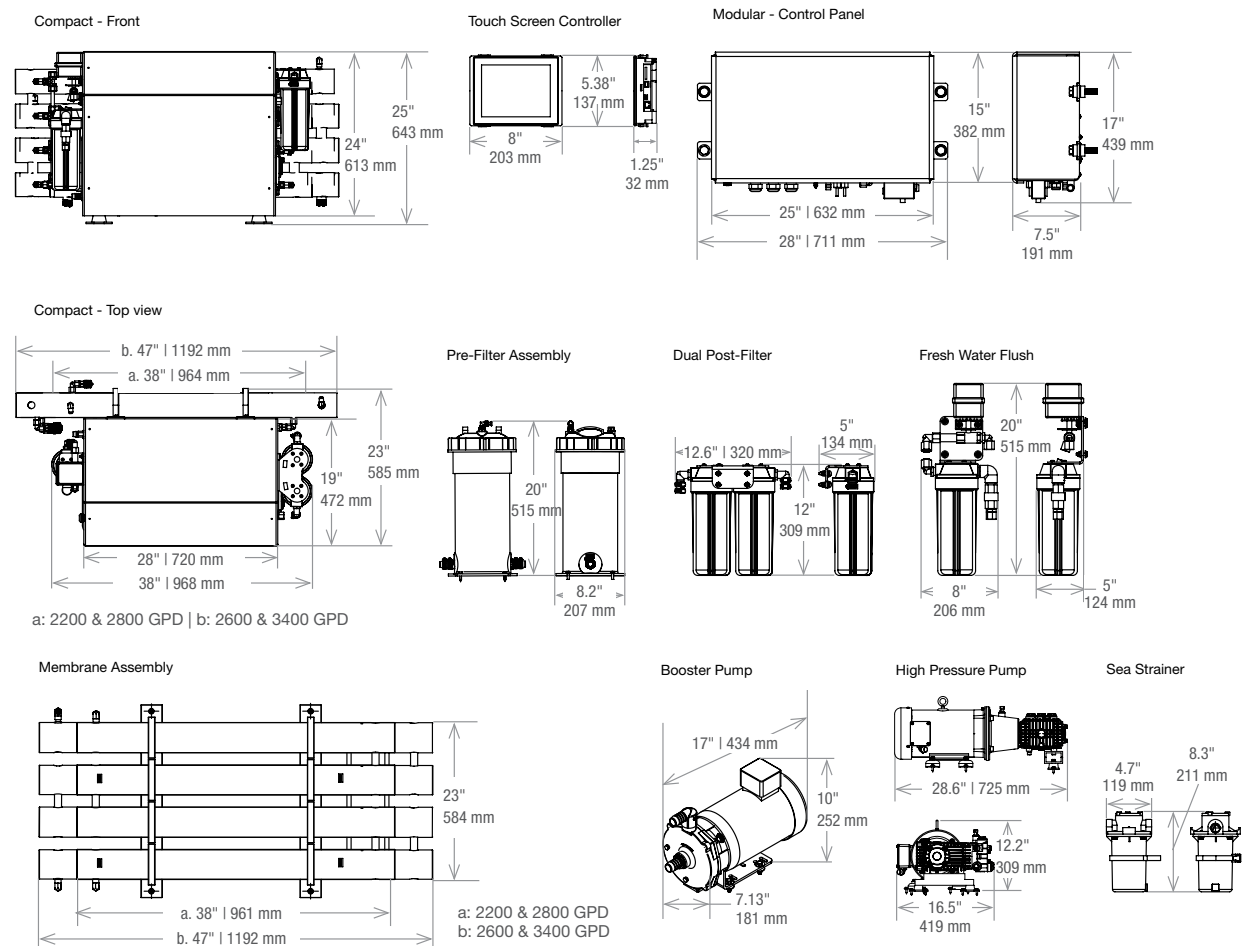

To maintain peak performance, always use genuine Parker Village Marine replacement parts. We reserve the right to change our specifications or standards without notice.

⚠ WARNING: This product can expose you to chemicals including Di(2-ethylhexyl) phthalate (DEHP), which is known to the state of California to cause cancer and birth defects or other reproductive harm. For more information go to www.P65Warnings.ca.gov.

Aqua Matic Dual Pass v2

Mid to Mega Yachts
(over 80ft / 24m)



Features & Benefits

- Medium to high water production rates available
- Easy installation and fully automatic operation
- Low power consumption
- Small footprint for limited engine room spaces
- Durable construction can withstand the harsh marine environment and resist corrosion

Specifications

	Model #	Production/Hr.*		Production/ 24 Hrs.		Unit Weight
		Gallons	Liters	Gallons	Liters	
Productions and Weight	A410M-1000GPD	42	158	1000	3785	120 lbs./54.5 Kg
	A410M-1300GPD	54	205	1300	4921	120 lbs./54.5 Kg
	A410M-1900GPD	92	300	1900	7192	303 lbs./151.5 Kg
	A410M-2600GPD	108	410	2600	9842	303 lbs./151.5 Kg

ELECTRICAL

Model #	Phase	Pump Motor	Voltage VAC	Hz	Normal Operating Amps
A410M-1000-1300 GPD	Single	Booster	115/230	50/60	9.4/4.7//7.4/3.7
	Single	HP	110/220/115/230	50/60	21/10.5//21.2/10.6
	Three	Booster	208-230/460//190/380	60/50	2.5/2.4/1.2//2.2/1.1
	Three	HP	208-230/460//190/380	60/50	7/7.2/3.6//8.2/.41
A410M-1900-2600 GPD	Single	Booster	115/230	60/50	14.2/7.1//18.2/9.1
	Single	HP	220/230	50/60	24/21.8
	Three	Booster	220/380//230/460	50/60	5.4/2.7//5/2.5
	Three	HP	190/380//230/460	50/60	15.6/7.8//13.4/6.7

*Production may vary +/-20%.

WARNING: This product can expose you to chemicals including Di(2-ethylhexyl) phthalate (DEHP), which is known to the state of California to cause cancer and birth defects or other reproductive harm. For more information go to www.P65Warnings.ca.gov.

Tomorrow's Technology, Here Today

Introducing our new and most revolutionary member of the Sea Recovery Family. Specialized for those demanding ultra-pure and clean potable water.

Use Ultra-Pure Water to Leave Your Boat Spotless and Clean.

Dimensions

Compact

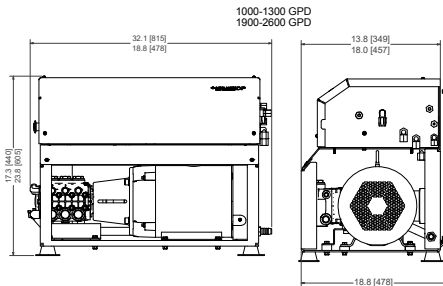

Modular

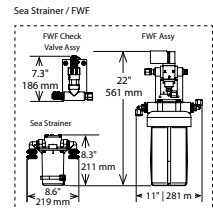
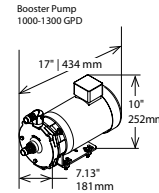
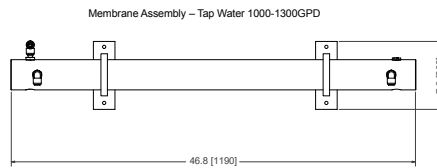
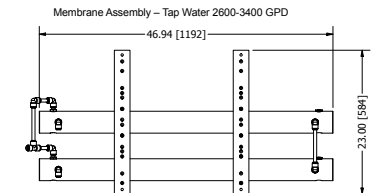
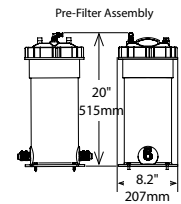
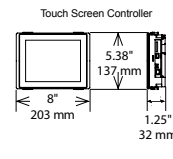
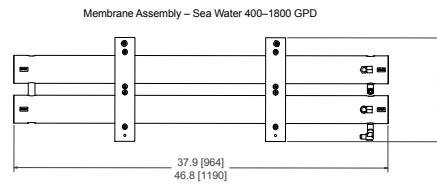
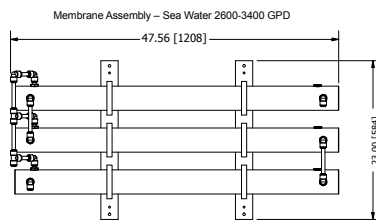
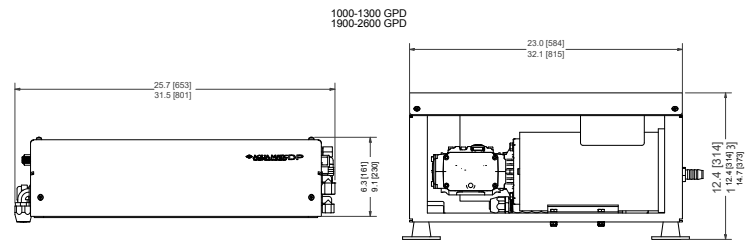

To maintain peak performance, always use genuine Parker Sea Recovery and Village Marine the global leader in motion and control technologies, reverse osmosis water desalination, purification, and filtration units replacement parts. We reserve the right to change our specifications or standards without notice.

To maintain peak performance, always use genuine Parker Village Marine replacement parts. We reserve the right to change our specifications or standards without notice.

⚠ WARNING: This product can expose you to chemicals including Di(2-ethylhexyl) phthalate (DEHP), which is known to the state of California to cause cancer and birth defects or other reproductive harm. For more information go to www.P65Warnings.ca.gov.

Aqua² Duo Mega Yacht Series Watermarkers

2800 to 6800 GPD
442/1073 LPH



Product Features:

- State of the Art Controller Interface with Digital Display
- 5 Micron and Oily-Water Separator Pre-Filtration Included, Inside the Frame
- Analog Low Pressure Gauges and Brine Water Flow Meter for Better Accuracy
- Storage Tank Level Monitoring
- Enjoy Safe Operation with Low and High Pressure Protection
- Auto Fresh Water Flush
- External Booster Pump
- Post Filtration



Specifications

Model #*	Production/24 Hrs.		Production/Hr.		Weight	
	GPD	LPD	GPH	LPH	lbs	kg
A455C-2800	2800	10599	117	442	500	227
A455C-3600	3600	13627	150	568	550	250
A455C-4400	4400	16656	183	694	600	273
A455C-5200	5200	19684	217	820	650	296
A455C-5600	5600	21198	233	883	700	319
A455C-6800	6800	25741	283	1073	750	342

*Production may vary +/-20% | GPD: Gallons per day • LPD: Liters per day

Highest Production, Small Footprint, Simple Operation

Designed for higher capacity, more efficiency, and quieter operation. This system includes state-of-the-art features that are ideal for mega-yachts, commercial fishing vessels, work boats, charter boats, and private residences.

⚠ WARNING: This product can expose you to chemicals including Di(2-ethylhexyl) phthalate (DEHP), which is known to the state of California to cause cancer and birth defects or other reproductive harm. For more information go to www.P65Warnings.ca.gov.

Optional Accessories:

- B611000004 Remote Control
 - B5262000CV UV Sterilizer
 - External Media Filter*
 - External Media Filter/ Booster Pump Skid*
 - Installation Kit*
 - External Strainer*
 - External Soft Start**
- *Consult factory part number based on capacity
 **For 2800/442-3600/568 GPD/ LPH systems ONLY

A455C-2800 and A455C-3600

Electrical	Phase	Pump Motor	Voltage VAC	Hz	Normal Operating Amps*	Start Up Current
Plunger Pump	Single	High Pressure / Booster	110-115 / 220-230	50 / 60	110 / 220 / 30 / 15	110 / 220 / 100 / 50
	Three	High Pressure / Booster	220-230 / 380-460	50 / 60	220 / 380-440 / 11 / 5.5	220 / 380-460 / 30 / 15

*Amps are based on a single system

Circuit Breaker Size	Operating AC Voltage	Phase	Recommended Circuit Breaker
Plunger Pump	110-115 / 220-230	Single	40 Ampere / 20 Ampere
	220 / 380 / 460	Three	15 Ampere / 10 Ampere / 10 Ampere

A455C-4400 to A455C-6800

Electrical	Phase	Booster Pump Motor	Voltage VAC	Hz	Normal Operating Amps*	Start Up Current
Plunger Pump	Three	1.5 / 2	220 / 380 / 230 / 460	50 / 60	5.2 / 2.6 / 5.8 / 2.9	24 / 16 / 27 / 14
	Single	1.5 / 1	115 / 230	50 / 60	14.2 / 7.1 / 18.2 / 9.1	54

*Amps are based on a single system

AC Voltage	Hz	Phase*	Normal Operating Amps	Circuit Breaker Amp
190 / 380	50	3	15.6 / 7.8	80 / 60
208 / 230 / 460	60	3	13.9 / 13.4 / 6.7	80 / 60
230 / 220	50 / 60	1	21.8 / 24	80 / 85

Dimensions

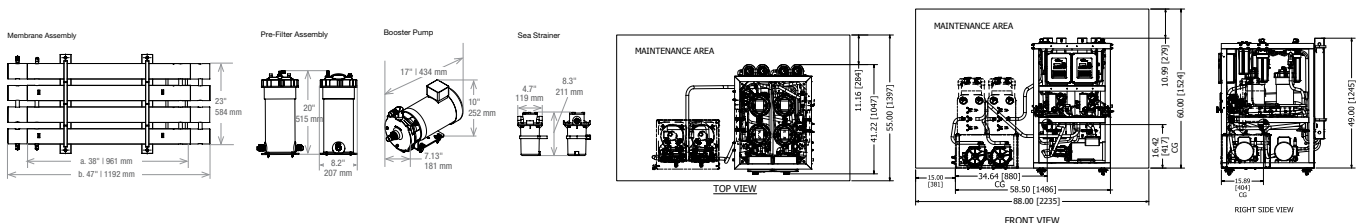

To maintain peak performance, always use genuine Parker Village Marine replacement parts. We reserve the right to change our specifications or standards without notice.

WARNING: This product can expose you to chemicals including Di(2-ethylhexyl) phthalate (DEHP), which is known to the state of California to cause cancer and birth defects or other reproductive harm. For more information go to www.P65Warnings.ca.gov.

ULTR^{RO} CLEAR^{DFII}

1,200 GPD to 2,400 GPD

Features & Benefits

- Direct feed from watermaker
- Simple, reliable, and easy to use
- Highly efficient, fully automatic operation
- Spot free rinse



Specifications

Part No.	Capacity	Production/Hr	Production/Day	Number of Membranes	Electrical VAC/Ph/Hz	Full Load Amps (FLA)	Weight
UC1200-116	1200 GPD	50 Gal/189 Lit	1200 Gal/4536 Lit	1	110/1/60	5.2	50 lbs/23kg
UC1200-215	1200 GPD	50 Gal/189 Lit	1200 Gal/4536 Lit	1	230/1/50	3.3	50 lbs/23kg
UC2400-116	2400 GPD	100 Gal/378 Lit	2400 Gal/9072 Lit	2	110/1/60	5.2	55 lbs/25kg
UC2400-215	2400 GPD	100 Gal/378 Lit	2400 Gal/9072 Lit	2	230/1/50	3.3	55 lbs/25kg

*Higher capacity systems are available upon request.

WARNING: This product can expose you to chemicals including Di(2-ethylhexyl) phthalate (DEHP), which is known to the state of California to cause cancer and birth defects or other reproductive harm. For more information go to www.P65Warnings.ca.gov.

Simple, Direct Feed to Your Current Watermaker

The Ultra Clear DF works with your RO system to convert sea water to double purified water. Its reliable piping connection allows direct feed that activates an automatic operation, and produces spot free water when water is directly fed into the system.

Ultra-pure water is 99% free of water solids. Perfect for rinsing hulls, windows, and extending the life of your boating equipment. It gently lifts debris and dries spot free.



Spares

Part No.	Description
85-0102	Clean Cartridge Kit
33-0321-X	Element, Brackish WTR, XLE-3021
3131420156	Meter DS Pocket (TDS4)
6102028	Kit, Installation, TDS, UC-DF

Dimensions

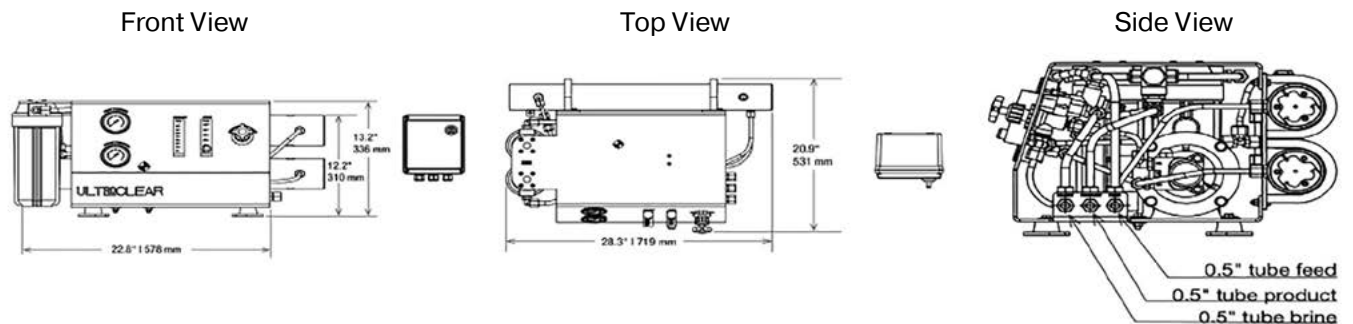

To maintain peak performance, always use genuine Parker Village Marine replacement parts. We reserve the right to change our specifications or standards without notice.

⚠ WARNING: This product can expose you to chemicals including Di(2-ethylhexyl) phthalate (DEHP), which is known to the state of California to cause cancer and birth defects or other reproductive harm. For more information go to www.P65Warnings.ca.gov.

Pure Water Series

400-2,000 GPD (1.5-7.5 m³/day)



Standard Features:

- Monel mesh strainer and dual sediment prefilters.
- Maintenance-free air/oil separator allows operation while underway.
- Low RPM five plunger titanium pump for minimum vibration and noise with unsurpassed corrosion resistance.

Specifications

Model	Part Number	Power Volts/phase/Hertz/Amps	Capacity GPH-m ³ /D	Dimensions W x D x H Inch (cm)	Weight lbs./kg
PW-400	90-8633	110 / 1 / 60 / 13	17-1.5	27 (69) x 24 (61) x 16 (41)	225/102
	90-8217	220 / 1 / 60 / 8			
	90-8513	220 / 3 / 60 / 6			
	90-8036	230 / 1 / 50 / 8			
	90-8238	380 / 3 / 50 / 3			
	90-8037	440 / 3 / 60 / 3			
PW-600	90-8125	110 / 1 / 60 / 21	25-2.3	54 (137) x 24 (61) x 16 (41)	350/159
	90-8006	220 / 1 / 60 / 11			
	90-8223	220 / 3 / 60 / 7			
	90-8636	230 / 1 / 50 / 11			
	90-8635	380 / 3 / 50 / 4			
	90-8634	440 / 3 / 60 / 4			
PW-800	90-8028	220 / 1 / 60 / 17	34-3.0	54 (137) x 24 (61) x 16 (41)	350-159
	90-8637	220 / 3 / 60 / 11			
	90-8047	230 / 1 / 50 / 15			
	90-8638	380 / 3 / 50 / 6			
	90-8292	440 / 3 / 60 / 6			
PW-1200	90-8038	220 / 1 / 60 / 17	50-4.5	54 (137) x 24 (61) x 16 (41)	400-182
	90-8210	220 / 3 / 60 / 11			
	90-8606	230 / 1 / 50 / 15			
	90-8212	380 / 3 / 50 / 6			
	90-8040	440 / 3 / 60 / 6			
PW-1600	90-8600	220 / 1 / 60 / 19	67-6.0	54 (137) x 28 (81) x 16 (41)	425/193
	90-8603	220 / 3 / 60 / 16			
	90-8601	230 / 1 / 50 / 25			
	90-8017	380 / 3 / 50 / 8			
	90-8604	440 / 3 / 60 / 8			
PW-2000	90-8554	220 / 1 / 60 / 19	84-7.5	54 (137) x 28 (81) x 16 (41)	450/205
	90-8039	220 / 3 / 60 / 16			
	90-8597	230 / 1 / 50 / 25			
	90-8598	380 / 3 / 50 / 8			
	90-8011	440 / 3 / 60 / 8			

WARNING: This product can expose you to chemicals including Di(2-ethylhexyl) phthalate (DEHP), which is known to the state of California to cause cancer and birth defects or other reproductive harm. For more information go to www.P65Warnings.ca.gov.

For Commercial Marine Applications

The Pure Water (PW) Series is designed to provide installation flexibility, superior performance, and extended service life in the most rugged conditions.

Designed for 24/7, continuous duty applications, where reliable fresh water supply is critical.

Standard Features (cont.):

- Magnetic drive low pressure pump provides up to 10 psi of boost pressure to the filtration system. No mechanical seal to reduce maintenance requirement.
- Stainless steel, glycerin filled pressure gauges.
- Freshwater flush system is added as either manual flush or optional automatic flush.
- Adjustable 316 SS pressure regulating valve allows use in fresh, brackish or seawater.
- Easy to operate 316 SS high pressure bypass valve controls the operating mode and allows high pressure bypass for start-up and low pressure flushing without.

Spares and Consumables

Part Number	Description
85-0050	Pump Oil
33-0005	Prefilter Element, 5 micron
33-0020	Prefilter Element, 20 micron (models 800+)
33-0311	Flush Filter (models 400, 600)
33-0315	Flush Filter (models 800+)
30-0040	Strainer Element
30-0405	O-Ring, Prefilter Housing
90-0005	O-Ring, Flush Housing (models 400, 600)

Part Number	Description
33-0271	O-Ring, Flush Housing (models 800+)
33-2519	Membrane (model 400)
33-0238	Membrane (models 600+)
90-2512	O-Ring Kit, Membrane Housing
90-0562	Clean and Preservation Kit
70-6184	HP Pump Service Kit
20-4096	Salinity Probe
20-0005/20-2001/20-0243	Fuses (1 of each)

Compact System Dimensions

Front View

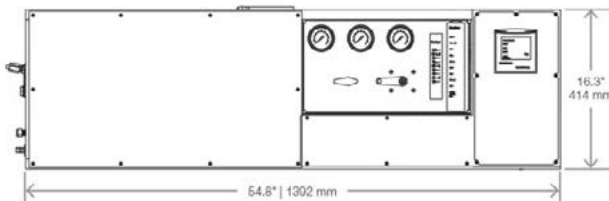

Profile View

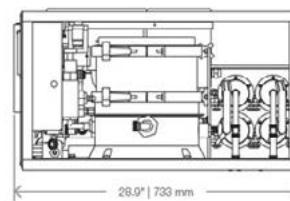

To maintain peak performance, always use genuine Parker Village Marine replacement parts. We reserve the right to change our specifications or standards without notice.

WARNING: This product can expose you to chemicals including Di(2-ethylhexyl) phthalate (DEHP), which is known to the state of California to cause cancer and birth defects or other reproductive harm. For more information go to www.P65Warnings.ca.gov.

Platoon Reverse Osmosis System H2O-PRO



Key Features:

- Simple Operation
- Extremely energy efficient
- Quick set-up
- Light weight
- 100% tool-less maintenance
- Rugged Military fielded design



Specifications

Model	Part No.	Capacity	Power	Weight	Dimension (LWH)
H2O Pro	0500134	25 GPH	24 VDC & 120 VAC	130 lbs	31.6" x 23" x 19"

⚠ WARNING: This product can expose you to chemicals including Di(2-ethylhexyl) phthalate (DEHP), which is known to the state of California to cause cancer and birth defects or other reproductive harm. For more information go to www.P65Warnings.ca.gov.

The Village Marine H2O-PRO unit provides fresh water from any water source, including seawater. The H2O-PRO will process 25 gallons per hour from 24 VDC or 120 VAC power.

- Cleanable Light weight prefilter
- Two staged 20 and 5 micron sediment filtration
- Reverse Osmosis system



Inside Panel



Hose/Tube Conn. Ports



Filter Standup

- USMC Selected - Platoon Water Purification System (PWPS)
- NSN 4610-01-688-0542
- Energy efficient - less than 700 Watts on Seawater or 400 Watts on Freshwater
- Quiet operation - less than 65dB
- Operate with case close for harsh environments
- External filter change out for simplified maintenance.
- Ultra simple tool - less membrane change out
- Cleanable Light weight Prefilter for source water up to 250 NTU
- Auxiliary Case contains AC & Battery power supplies, water test kit, spare parts, cables and hoses.

To maintain peak performance, always use genuine Parker Village Marine replacement parts. We reserve the right to change our specifications or standards without notice.

⚠ WARNING: This product can expose you to chemicals including Di(2-ethylhexyl) phthalate (DEHP), which is known to the state of California to cause cancer and birth defects or other reproductive harm. For more information go to www.P65Warnings.ca.gov.

Coral Sea Watermakers

3,800-6,800 GPD

14-26 m³/D



Features & Benefits

- Enhanced safety designed into the process and operation of the system.
- Easy to maintain.
- Vertical configuration standard.
- Optional configurations voltages available upon request.
- Advanced digital controls.
- Short manufacturing lead times.
- Oil-free pump.
- Large HMI interface.
- All automatic controls and instruments for safe & reliable operations.



Specifications

Part Number A550 Vertical, A551 Horizontal, A552 Modular	Voltage	Capacity M ³ /Day	Permeate GPD	Vertical Dimensions (in/cm)		
				Length	Width	Height
-13	440-480 / 3 / 60	14	3800	30/76	34/86	60/152
-15	380-410 / 3 / 50	14	3800	30/76	34/86	60/152
-23	440-480 / 3 / 60	16	4200	30/76	34/86	60/152
-25	380-410 / 3 / 50	16	4200	30/76	34/86	60/152
-33	440-480 / 3 / 60	20	5200	30/76	34/86	60/152
-35	380-410 / 3 / 50	20	5200	30/76	34/86	60/152
-43	440-480 / 3 / 60	23	6200	34/86	34/86	60/152
-45	380-410 / 3 / 50	23	6200	34/86	34/86	60/152
-53	440-480 / 3 / 60	26	6800	38/97	34/86	60/152
-55	380-410 / 3 / 50	26	6800	38/97	34/86	60/152

WARNING: This product can expose you to chemicals including Di(2-ethylhexyl) phthalate (DEHP), which is known to the state of California to cause cancer and birth defects or other reproductive harm. For more information go to www.P65Warnings.ca.gov.

Available Options:

- MODBUS communication
- Custom Flanges
- pH neutralizer
- External Strainer
- Carbon Filter (Palatability Filter)

Optional Accessories:

- pH neutralizer
- IMF media filter (Auto/Man)
(See separate brochure)
- Chemical dosing system*
(See separate brochure)
- UV Sterilizer*
- External strainer

*Requires Transformer Panel for RO System Control
Part No. 0901166 for 380V-410V RO Systems
Part No. 0901008 for 440V-480V RO Systems

Consumables/Spare Parts

Part Number	Description
40012014	20 Micron Cartridge Filter Element
40012013	5 Micron Cartridge Filter Element
40012004	CIP Cleaning Element #1
40012005	CIP Cleaning Element #2
40012019	Preservation Chemical Element #3
0803004873	FWF Element Charcoal
21-1122	Parker Membrane Lubricant, Single Use Packet
2724011433	Seawater RO Membrane Element
91-3557	Handheld Water Quality Meter

Flange Kit Options

Part Number	Description
61012038	Flange Kit - C/S ANSI, PVC
61012039	Flange Kit - C/S DIN, PN16
61012040	Flange Kit - C/S JIS, 10K
90-5160	Operation Manual - Paper Copy
90-5165	Operation Manual - Electronic Copy (no charge)

Dimensions

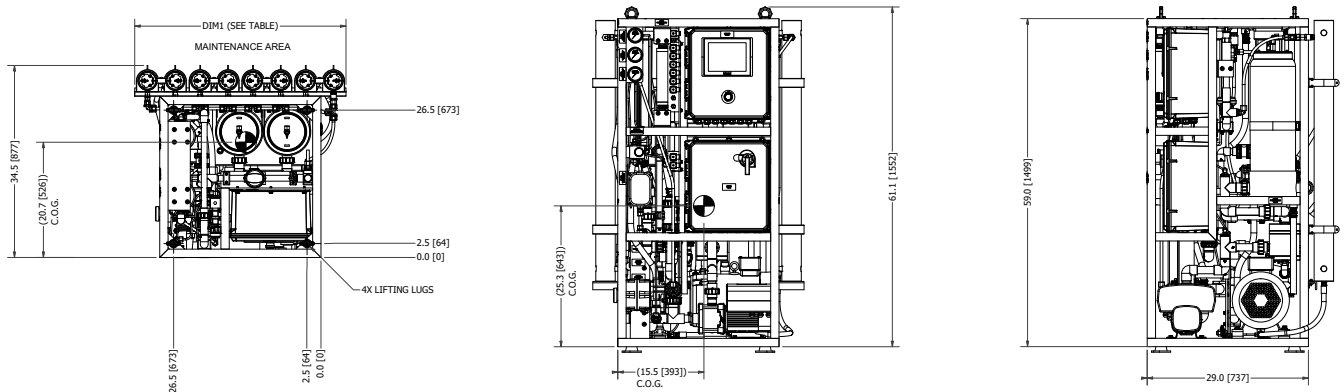

To maintain peak performance, always use genuine Parker Village Marine replacement parts. We reserve the right to change our specifications or standards without notice.

⚠ WARNING: This product can expose you to chemicals including Di(2-ethylhexyl) phthalate (DEHP), which is known to the state of California to cause cancer and birth defects or other reproductive harm. For more information go to www.P65Warnings.ca.gov.

Tasman Sea Watermakers

8,000-18,000 GPD

30-68 m³/D



Features & Benefits

- Oil-free pump
- An Automated Screen Alerts the Operator of Required Maintenance
- All controls & instrumentation for safe and reliable operations
- Compact design
- Automatic control
- Built in cleaning system



Specifications

Part Number A600	Voltage	Capacity GPD/ M ³ /D	Permeate GPD	Weight lbs/kg	Quantity	Membranes Required
-30	440-480 / 60 / 3	30	8000	1291 / 585	2	32-6060
-31	380-410 / 50 / 3			1397 / 633		
-38	440-480 / 60 / 3	38	10000	1388 / 630	3	
-39	380-410 / 50 / 3			1494 / 678		
-44	440-480 / 60 / 3	45	12000	1388 / 630	4	
-45	380-410 / 50 / 3			1494 / 678		
-61	440-480 / 60 / 3	61	16000	1485 / 674	4	
-62	380-410 / 50 / 3			1591 / 722		
-67	440-480 / 60 / 3	68	18000	1485 / 674		
-68	380-410 / 50 / 3			1591 / 722		

*Production may vary +/-20%. For other configuration please inquire with factory.

WARNING: This product can expose you to chemicals including Di(2-ethylhexyl) phthalate (DEHP), which is known to the state of California to cause cancer and birth defects or other reproductive harm. For more information go to www.P65Warnings.ca.gov.

Rugged Design, Mid-Range Production, Quality Throughout

The dependable Tasman Sea series ideally suits the mid-range production requirements of reverse osmosis desalination. Small hotels, villas, oil platforms, mid-sized commercial vessels, and small cruise ships throughout the world rely on the dependability of Tasman Sea series.

The compact yet easily accessible design and maintainable configuration incorporate exclusive features found in no other desalinators. Tasman Sea frames are constructed from light-weight epoxy powder-coated aluminum.

Consumables/Spare Parts

Part Number	Description
33-5105	Filter, 20 Micron
33-5104	Filter, 5 Micron
0803005173	Element Charcoal
20-4096	Probe, Conductivity
2317100701	Transducer 300
2317102001	Transducer 0-2000
40012008	CIP Cleaning Element #1
40012009	CIP Cleaning Element #2
40012021	Preservation Chemical Element #3
21-1122	Silicone Grease, Slube 884-2
91-3557	Meter, TDS, PH, Handheld, Digital
33-6030*	Element, Sea Water
90-5160	Operation Manual, Paper Copy
90-5165	Operation Manual, Electronic Copy (No Charge)

*Membrane elements are sold separately.

Flange Kit Options

Part Number	Description
61012054	Flange Kit - T/S ANSI, PVC
61012055	Flange Kit - T/S DIN, PN16, PVC
61012056	Flange Kit - T/S JIS, 10K, PVC

Optional Accessories:

- pH neutralizer
- IMF media filter (Auto/Man)
- Chemical dosing system*
- UV Sterilizer*
- External strainer

*Requires Transformer Panel for RO System Control
Part No. 0901166 for 380V-410V RO Systems
Part No. 0901008 for 440V-480V RO System

Dimensions

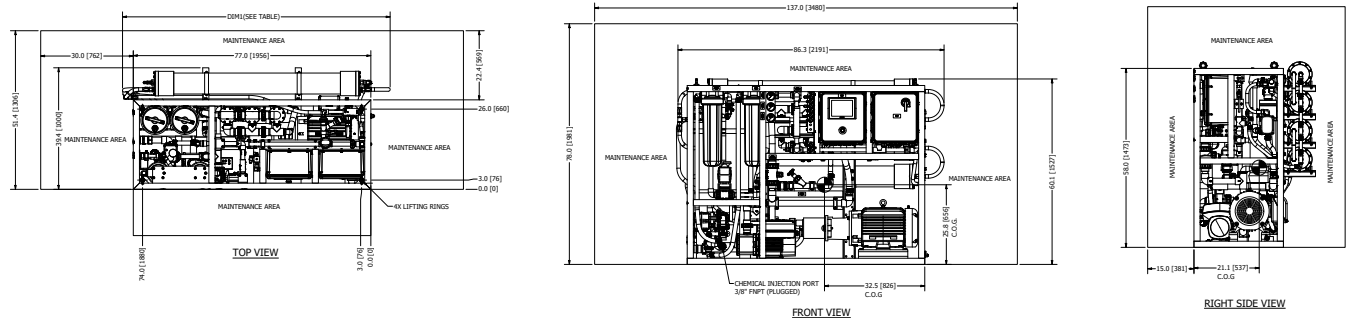

To maintain peak performance, always use genuine Parker Village Marine replacement parts. We reserve the right to change our specifications or standards without notice.

⚠ WARNING: This product can expose you to chemicals including Di(2-ethylhexyl) phthalate (DEHP), which is known to the state of California to cause cancer and birth defects or other reproductive harm. For more information go to www.P65Warnings.ca.gov.

North Sea Watermakers

27,700-25,800 GPD

105-200 m³/D



Features & Benefits

- Oil-free pump
- An Automated Screen Alerts the Operator of Required Maintenance
- All controls and instrumentation for safe and reliable operation
- Compact design
- Automatic control
- Built in cleaning system



Specifications

Part Number A650	Voltage	Capacity M ³ /Day*	Permeate GPD	Weight lbs/kg	Quantity	Membranes Required*
-105	440-480 / 60 / 3	105	27700	2432 / 1103	6	27240331PK
-106	380-415 / 50 / 3					
-145	440-480 / 60 / 3	145	38300	2782 / 1262	9	
-146	380-415 / 50 / 3					
-175	440-480 / 60 / 3	175	46200	3088 / 1400	12	
-176	380-415 / 50 / 3					
-200	440-480 / 60 / 3	200	52800	3181 / 1442	15	
-201	380-415 / 50 / 3					

*Technical water configuration available upon request.

*Production may vary +/-20%. For other configuration please inquire with factory.

*Membrane elements are sold separately.

WARNING: This product can expose you to chemicals including Di(2-ethylhexyl) phthalate (DEHP), which is known to the state of California to cause cancer and birth defects or other reproductive harm. For more information go to www.P65Warnings.ca.gov.

The Reliable Choice for Unlimited Fresh Water Production

The North Sea Series is the top choice of the offshore and commercial marine industry. It has the capacity to provide up to 200 metric tons of fresh water per day. With minimal space and maintenance requirements, the new North Sea has multiple controller configuration options, and provides maximum utility of space while incorporating ease of control and safety standards.

Optional Features: Optional Accessories:

- MODBUS communication
- Custom flanges

- pH neutralizer
- IMF media filter (Auto/Man)
- Chemical dosing system*
- UV sterilizer*
- External strainer

*Requires Transformer Panel

Consumables/Spare Parts

Part Number	Description
33-5105	Filter, 20 Micron
33-5104	Filter, 5 Micron
0803005173	Element Charcoal
20-4096	Probe, Conductivity
2317100701	Transducer 300 PSIA
2317102001	Transducer 0-2000 PSIG
40012008	CIP Cleaning Element #1

Part Number	Description
40012009	CIP Cleaning Element #2
40012021	Preservation Chemical Element #3
21-1122	Silicone Grease, Slube 884-2
91-3557	Meter, TDS, PH, Handheld, Digital
27240331PK*	Element Sea water
Call factory	Operation Manual, Paper Copy
Call factory	Operation Manual, Electronic Copy (No Charge)

Flange Kit Options

Part Number	Description
Call factory	Flange Kit - T/S ANSI, PVC
Call factory	Flange Kit - T/S DIN, PN16, PVC
Call factory	Flange Kit - T/S JIS, 10K, PVC

Dimensions

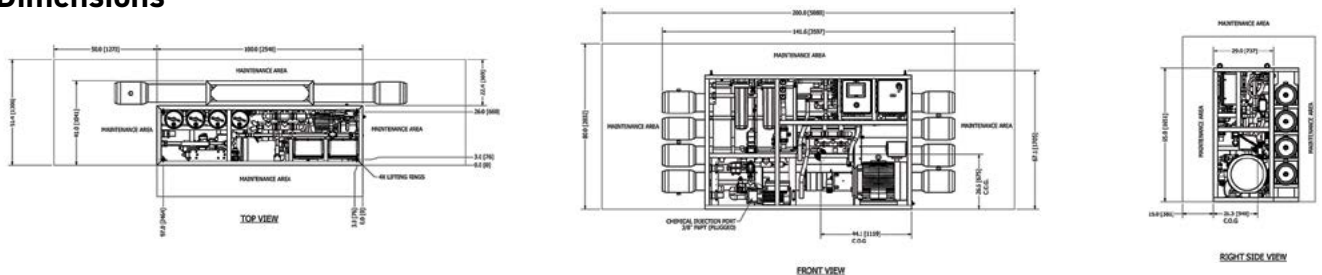

To maintain peak performance, always use genuine Parker Village Marine replacement parts. We reserve the right to change our specifications or standards without notice.

⚠ WARNING: This product can expose you to chemicals including Di(2-ethylhexyl) phthalate (DEHP), which is known to the state of California to cause cancer and birth defects or other reproductive harm. For more information go to www.P65Warnings.ca.gov.

Sea Recovery Atlantic Sea Series

Safe, Reliable, and Supported
Anywhere in the World



Features & Benefits

- Mega production - 1,200 metric tons and above per day
- Digital control with standard MODBUS
- Low-maintenance HP pump
- Energy Recovery
- One-touch start up with instant-on feature



Specifications

A700 Daily System Production	Production/Hour	Production/24 Hrs.
250 M ³ /day	2,752 gal	66,043 gal
300 M ³ /day	3,302 gal	79,252 gal
400 M ³ /day	4,403 gal	105,669 gal
500 M ³ /day	5,504 gal	132,086 gal
600 M ³ /day	6,604 gal	158,503 gal
750 M ³ /day	8,255 gal	198,129 gal
1000 M ³ /day	11,007 gal	264,172 gal
1200 M ³ /day	13,209 gal	317,006 gal

WARNING: This product can expose you to chemicals including Di(2-ethylhexyl) phthalate (DEHP), which is known to the state of California to cause cancer and birth defects or other reproductive harm. For more information go to www.P65Warnings.ca.gov.

Efficiently Productive

The Atlantic Sea is Parker Sea Recovery's Largest series of standard Sea water Reverse Osmosis systems. Its features include a small footprint and fully-automatic controls with the capacity to 1,200 metric tons per day. The Atlantic Sea also boasts the lowest consumption of energy per ton of water produced in the market. This is perfect for those who require an unlimited amount of fresh water anywhere at anytime.

From its fully-automated controller to its low-maintenance HP pump and its energy-recovery system, the Atlantic Sea effortlessly delivers high production capacities. Its automated controller is easy to operate and enables real-time remote monitoring of essential system functions.

The Atlantic Sea's high-pressure pump is the most compact and efficient pump on the market. Its flexible installation doesn't require frames, belt drives or gear boxes. The HP pump is corrosion-resistant and completely eliminates oil leaks and membrane fouling caused by oil leaks.

The Atlantic Sea is capable of instant-on start-up that allows the system to produce usable, fresh water within minutes.

Dimensions

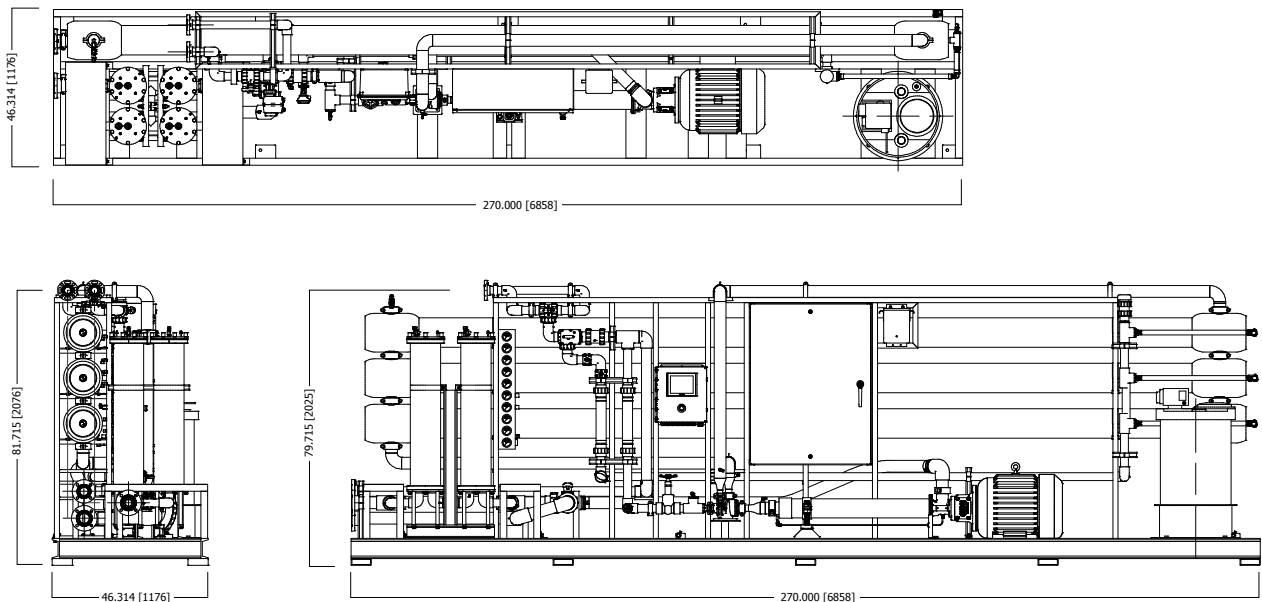

To maintain peak performance, always use genuine Parker Village Marine replacement parts. We reserve the right to change our specifications or standards without notice.

⚠ WARNING: This product can expose you to chemicals including Di(2-ethylhexyl) phthalate (DEHP), which is known to the state of California to cause cancer and birth defects or other reproductive harm. For more information go to www.P65Warnings.ca.gov.

LT Watermakers

3000 to 7000 GPD

(11 to 27 m³/D)



Features & Benefits

- Stainless steel high pressure pump is resistant to the corrosive seawater environment.
- Fiberglass cartridge filter housing holds 100 square foot 5 micron element.
- Marine bronze low pressure pp provides up to 50 psi of boost pressure to the filtration system.
- Glycerine filled pressure gauges.
- Flowmeters to monitor freshwater and reject rates.
- Freshwater flush system included standard.
- 316 stainless steel pressure regulator is adjustable to allow operation in brackish or fresh water.
- Electrical control panel Nema 4X with motor starter and pump controls.
- Automatic diversion valve diverts water to overboard if quality drops below acceptable standards.
- Digital water quality monitor displays purity of product water produced.



Specifications

Model	Part Number*	Power Volts/ phase/Hz/Amps	Dimensions** inch/cm	Capacity GPH-m ³ /Day	Weight
LT-3000	90-6057	220/1/60/53	width 40/102	125/11	1060/480
	90-6059	440/3/60/17	depth 39/99		
	90-6058	380/3/50/17	height 62/157		
LT-4000	90-6060	220/1/60/53	width 40/102	167/15	1080/490
	90-6062	440/3/60/17	depth 39/99		
	90-6061	380/3/50/17	height 62/157		
LT-5000	90-6063	440/3/60/22	width 40/102	208/20	1140/520
	90-6031	380/3/50/24	depth 39/99 height 62/157		
LT-7000	90-6065	440/3/60/22	width 40/102	292/27	1290/585
	90-6064	380/3/50/24	depth 43/109 height 62/157		

*Add part number 90-0264 to include optional media filter.

**Includes membrane rack mounted vertically. Does not include boost pump or optional media filter that increase width to 56/142.

WARNING: This product can expose you to chemicals including Di(2-ethylhexyl) phthalate (DEHP), which is known to the state of California to cause cancer and birth defects or other reproductive harm. For more information go to www.P65Warnings.ca.gov.

Practical and Reliable Fresh Water Supply

The LT desalinator offers a simple watermaker package with a compact frame and small footprint. LT systems have a base frame only 40" wide x 33" deep, allowing a high capacity and high quality watermaker installation in a tight space.

Key Feature - Installation Flexibility



LT units can be supplied with an optional media filter system. Also membrane rack can be mounted horizontally or as a module for remote bulkhead mounting.

Spares and Consumables

Part Number	Description	Part Number	Description
33-5100	Filter Cartridge - 5 micron	32-1016	Membrane O-Ring Kit (LT-7000)
30-0405	O-Ring Seal - Filter Housing	40-0241	Salinity Probe
33-0315	Carbon Flush Filter Element	33-0440	RO Membrane (up to LT 5000)
70-1448	Drive Belt - Check for Exact Size	33-0036	RO Membrane (LT-7000)
85-0050	Pump Oil - Quart Bottle	85-0045	Membrane Cleaner #1, 25 lbs. pail
90-2323	Membrane O-Ring Kit (up to LT-5000)	85-0048	Membrane Cleaner #2, 25 lbs. pail
		85-0049	Membrane Preservative, 25 lbs. pail

Media Required

Part Number	Description	Qty
85-5006	Media #0, Fine Gravel, 3.5 Gal, Pail, 46 lbs	1
85-5010	Media #5, High Perf Sand, 5 Gal, Pail, 37 lbs	6

Note:
Media sold separately

WARNING - USER RESPONSIBILITY

FAILURE OR IMPROPER SELECTION OR IMPROPER USE OF THE PRODUCTS DESCRIBED HEREIN OR RELATED ITEMS CAN CAUSE DEATH, PERSONAL INJURY AND PROPERTY DAMAGE.

- This document and other information from Parker-Hannifin Corporation, its subsidiaries and authorized distributors provide product or system options for further investigation by users having technical expertise.
- The user, through its own analysis and testing, is solely responsible for making the final selection of the system and components and assuring that all performance, endurance, maintenance, safety and warning requirements of the application are met. The user must analyze all aspects of the application, follow applicable industry standards, and follow the information concerning the product in the current product catalog and in any other materials provided from Parker or its subsidiaries or authorized distributors.
- To the extent that Parker or its subsidiaries or authorized distributors provide component or system options based upon data or specifications provided by the user, the user is responsible for determining that such data and specifications are suitable and sufficient for all applications and reasonably foreseeable uses of the components or systems.

To maintain peak performance, always use genuine Parker Village Marine replacement parts. We reserve the right to change our specifications or standards without notice.

 **WARNING:** This product can expose you to chemicals including Di(2-ethylhexyl) phthalate (DEHP), which is known to the state of California to cause cancer and birth defects or other reproductive harm. For more information go to www.P65Warnings.ca.gov.

Commercial Pure Water Series

PW 3000-18000 GPD
(11-68 m³/day)



Standard Features:

- Fiberglass pre-Filtration housings deliver 200 Sq. ft. of filtering area
- Stainless steel, glycerin-filled pressure gauges accurately read pressure at filters, pump and product
- Stainless steel 316L high pressure valve allows bypass for start-up and low pressure flushing without readjustment of regulating valve



Specifications

Model	Part Number	Power Volts/phase/Hertz/Amps	Capacity GPH/m ³	Dimensions W x D x H inch/cm	Weight lbs./kg
PW-3000	90-8651	220/1/60/53	125/11	84/213 x 34/86 x 35/89	800/364
	90-8206	380/3/50/17			
	90-8236	440/3/60/17			
PWM-3000	90-8653	440/3/60/17		Modular	
PW-4000	90-8262	220/1/60/53	167/15	84/213 x 34/86 x 35/89	900/409
	90-8243	380/3/50/17			
	90-8240	440/3/60/17			
PWM-4000	90-8655	440/3/60/17		Modular	
PW-5000	90-8656	380/3/50/24	208/20	84/213 x 34/86 x 35/89	1000/455
	90-8599	440/223/60/22			
PWM-5000	90-8257	440/3/60/22		Modular	
PW-6000	90-8070	380/3/50/24	250/25	84/213 x 44/111 x 35/89	1050/477
	90-8657	440/3/60/22			
PWM-6000	90-8261	440/3/60/22		Modular	
PW-7000	90-8659	380/3/50/24	292/27	84/213 x 48/121 x 35/89	1500/682
	90-8245	440/3/60/22			
PWM-7000	90-8658	440/3/60/22		Modular	
PW-8000	90-8214	380/3/50/28	333/30	84/213 x 48/121 x 35/89	1600/727
	90-8203	440/3/60/27			
PWM-8000	90-8660	440/3/60/27		Modular	
PW-10000	90-8051	380/3/50/28	417/40	84/213 x 48/121 x 35/89	1800/818
	90-8073	440/3/60/27			
PWM-10000	90-8661	440/3/60/27		Modular	
PW-12000	90-8258	380/3/50/37	500/45	88/223 x 52/132 x 35/89	1900/864
	90-8284	440/3/60/33			
PWM-12000	80-8662	440/3/60/33		Modular	
PW-16000	90-8075	380/3/50/37	667/61	88/223 x 52/132 x 43/109	2200/1000
	90-8193	440/3/60/33			
PWM-16000	90-8126	440/3/60/33		Modular	
PW-18000	90-8232	380/3/50/43	750/68	88/223 x 52/132 x 43/109	2250/1022
	90-8543	440/3/60/39			
PWM-18000	90-8663	440/3/60/39		Modular	

⚠ WARNING: This product can expose you to chemicals including Di(2-ethylhexyl) phthalate (DEHP), which is known to the state of California to cause cancer and birth defects or other reproductive harm. For more information go to www.P65Warnings.ca.gov.

For Commercial Marine Applications

The Pure Water Series (PW) reverse osmosis desalination systems are the preferred choice of reliable fresh water generating equipment for the most demanding marine operators (such as major oil companies, The United States Navy, The United States Coast Guard and The Cousteau Society). Thousands of PW installations have proven the performance and longevity under the most rugged conditions.

Key Features:



Titan Head Pump

At the core of each PW series watermaker is the Aqua Pro 3 or 5-plunger titanium high pressure pump.



PWM-16000

Modular configuration enables freedom to install components where space permits, and the modules are small enough to fit through hatchways for installation.

Standard Features (cont.):

- Automatic valve diverts water to discharge if water quality drops below acceptable standards
- Digital water quality monitor displays ppm of total dissolved solids of product water output. Also displays temperature and total hours for accurate service logs.
- Freshwater flush system extends life of membranes without use of preservatives
- Optional multi-media filter for operations in turbid seas
- Optional explosion-proof rating available

Spares and Consumable Parts

Part Number	Description	Part Number	Description
33-5100	Filter Element - 5 micron	70-3075	Pump FE Kit - PW-8000 & up
33-2100	Filter Element, 20 micron	70-0624	Pump CC Kit - up to PW-7000
30-0405	Filter Housing O-Ring	70-3078	Pump CC Kit - PW-8000 & up
33-0315	Carbon Filter - up to PW-7000	90-2323	Membrane O-Ring Kit - up to PW-7000
33-0083	Carbon Filter - PW-8000 & up	32-1016	Membrane O-Ring Kit - PW-8000 & up
70-1448	Drive Belt - up to PW-7000	20-4100	Salinity Probe
70-1440	Drive Belt - PW-8000 & up	85-0045	Membrane Cleaner #1, 25 lbs
85-0050	Pump Oil, Quart	85-0048	Membrane Cleaner #2, 25 lbs
70-0623	Pump FE Kit - up to PW-7000	85-0049	Membrane Preservative, 25 lbs

To maintain peak performance, always use genuine Parker Village Marine replacement parts. We reserve the right to change our specifications or standards without notice.

WARNING: This product can expose you to chemicals including Di(2-ethylhexyl) phthalate (DEHP), which is known to the state of California to cause cancer and birth defects or other reproductive harm. For more information go to www.P65Warnings.ca.gov.

Offshore Desalinators SW Series

SW-24, SW-32, SW-40
(91, 120, 151 m³/day)

Standard Features:

- Single drop skid with two complete watermaker trains including media filter with back wash and rinse
- Fiberglass pre-filtration housings deliver 200 sq. ft. of filtering area per train
- Nickel-aluminum-bronze low pressure pumps drive seawater through the filtration system
- All 316 stainless steel high pressure piping, with titanium fittings where appropriate. Low pressure piping is PVC80 or, optionally, GRE for extra strength
- Full instrumentation including liquid-filled pressure gauges, acrylic flowmeters, digital conductivity meter and hour-meter
- Valving to allow simple startup pressure control, flushing, or clean in place recirculation for membrane cleaning
- Automatic diversion valves direct product water to discharge if water quality drops below acceptable standards

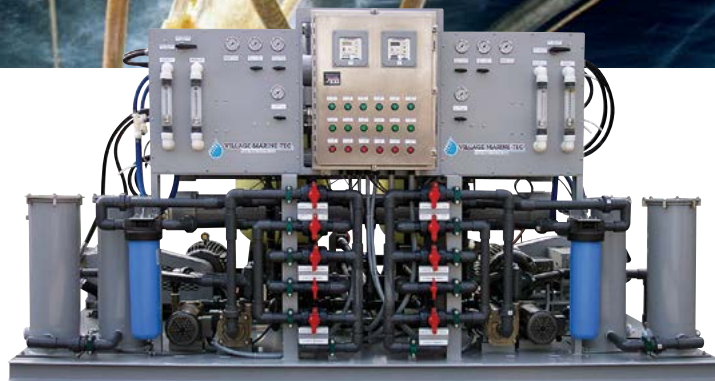

Specifications

Model	Part Number	Product Flow*		Power at 440/3/60	Skid Size	Operating Weight
		GPD	m ³ /day			
SW 24	90-8558	24000	91	60 Amps	142" long	6950 lbs
SW 32	90-8556	32000	120	60 Amps	72" deep	7300 lbs
SW 40	90-8608	40000	151	170 Amps	78" high	7500 lbs

*Product flow based on median seawater conditions, both trains running.

WARNING: This product can expose you to chemicals including Di(2-ethylhexyl) phthalate (DEHP), which is known to the state of California to cause cancer and birth defects or other reproductive harm. For more information go to www.P65Warnings.ca.gov.

For Offshore Rigs and Work-Camps Applications

The SW Series RO desalination systems are designed for rugged use in harsh environments that demand large quantity of potable water duty. Typical installations are offshore rigs, work camps, oceanfront resorts, or cruise ships.

Each SW unit comprises a single skid installation with two complete, independent RO systems. The two trains can run simultaneously or can be operated on a duty/ stand-by basis.

Key Feature:



At the core of each SW series watermaker is the Aqua Pro[®] 5 plunger high pressure pump:

- Titanium head for maximum corrosion resistance.
- Five plunger design allows lower rpm, lower noise and less vibration.
- Ceramic plungers and nylon valves will not corrode.



SW Series (back side view)



SW Series (right side view)

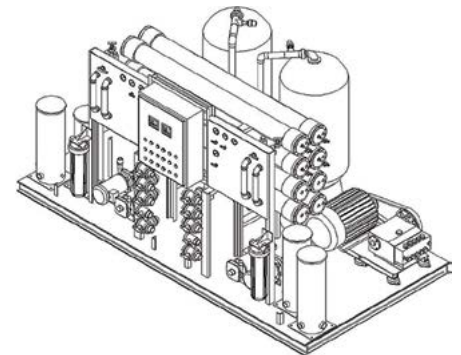

To maintain peak performance, always use genuine Parker Village Marine replacement parts. We reserve the right to change our specifications or standards without notice.

⚠ WARNING: This product can expose you to chemicals including Di(2-ethylhexyl) phthalate (DEHP), which is known to the state of California to cause cancer and birth defects or other reproductive harm. For more information go to www.P65Warnings.ca.gov.

Bilgewater Adsorbent Separator

BAS-500, BAS-1000,
BAS-2000, and BAS-2500

Features & Benefits:

- USCG Certified to meet IMO MEPC 107(49) regulations
- MEPC 107(49) certified oil content monitor included
- Advanced three-stage design for maximum oil separation
- Automated oil flush system
- Compact design minimizes installation requirement
- Certified compliant with European Union Marine Directive 2014/90/EU item MED. 1/2. 1
- Built in Push-to-Start (Priming) for quick operation



Specifications

Model #	Part Number	Power Volts/ phase/Hz	Dimensions inch/mm	Capacity GPM/m ³ /hr	Dry Weight lbs/kg	Operating Weight lbs/kg	Power (Amps)
BAS-500	90-5086	110/1/60	width 34.5/877 depth 28.33/119 height 50.9/1293	2.2 / .5	525/238	700/282	7.9
	90-5087	220/1/60					3.9
	90-5088	220/3/60					2.4
	90-5089	440/3/60					1.2
	90-5090	230/1/50					4.5
	90-5091	380/3/50					1.5
BAS-1000	90-5092	110/1/60	width 33/838 depth 46/1168 height 67/1701	4.4 / 1	630/286	880/399	7.4
	90-5093	220/1/60					3.7
	90-5094	220/3/60					2
	90-5095	440/3/60					1
	90-5096	230/1/50					3.6
	90-5097	380/3/50					1
BAS-2000	90-5098	110/1/60	width 44/1118 depth 66/1676 height 62/1575	8.8 / 2	1200/544	2090/948	7.9
	90-5099	220/1/60					3.9
	90-5100	220/3/60					2.4
	90-5101	440/3/60					1.2
	90-5102	230/1/50					3.6
	90-5103	380/3/50					1
BAS-2500	90-5104	110/1/60	width 44/1118 depth 66/1676 height 62/1575	11 / 2.5	1260/572	2150/975	7.4
	90-5105	220/1/60					3.7
	90-5106	220/3/60					21
	90-5107	440/3/60					3.6
	90-5108	230/1/50					1
	90-5109	380/3/50					1

*Water production capacity may be slightly less than rated for all 50 Hz units.

WARNING: This product can expose you to chemicals including Di(2-ethylhexyl) phthalate (DEHP), which is known to the state of California to cause cancer and birth defects or other reproductive harm. For more information go to www.P65Warnings.ca.gov.

Bilge Water Treatment

Parker Village Marine Tec. oily water separators meet the Village Marine Tec. IMO Resolution MEPC 107(49). The Village Marine Tec. units are an advanced three-stage system optimizing the separation and removal of free and emulsified oils.

Heavy duty construction, corrosion resistant materials, permanent oil attractant media, quiet operation, automatic diversion valves and advanced oil adsorbent media technology result in an easy to use, high quality, affordable solution to meet your bilge water treatment needs.

General Specifications:

- Inlet Connection:
3/4" FNPT on models
BAS-500 - BAS-1000
1-1/4" FNPT on models
BAS-2000 and BAS-2500
- Oil Discharge:
3/4" FNPT on all models
- Clean Water Flush Inlet:
3/4" FNPT on all models
maximum water pressure 20 psi
- Treated Water Outlet:
3/4" FNPT on all models

Spares and Consumable Parts

Part Number	Description	Part Number	Description
33-0057	Process filter 5 micron all models	20-0505	Light, Incandescent (110)
90-5026	Coalescer Media Fill Kit (model BAS-500)	20-0296	Relay level control 110 VAC/50-60
90-5028	Coalescer Media Fill Kit (model BAS-1000)	90-5030 Kit,	Adsorptive media replacement (BAS-500 - BAS-1000)
90-5029	Coalescer Media Fill Kit (models BAS-2000 & BAS-2500)	90-5031 Kit,	Adsorptive media replacement (BAS-2000 - BAS-2500)
33-0082	Process filter housing cover seal O-ring	30-1164	O-ring, Riser tube, Media filter
20-0029	Switch, 3-pos	30-0935	O-ring, Distributor head, Media filter
20-0028	Switch, 2-pos	70-0392	Feed pump seal kit
20-3004	Light, Indicator, Green	90012515	Push Button, Momen Tary, Red
20-3006	Light, Indicator, Red	0101018	Media Filter With Stand, BAS 500

WARNING - USER RESPONSIBILITY

FAILURE OR IMPROPER SELECTION OR IMPROPER USE OF THE PRODUCTS DESCRIBED HEREIN OR RELATED ITEMS CAN CAUSE DEATH, PERSONAL INJURY AND PROPERTY DAMAGE.

- This document and other information from Parker-Hannifin Corporation, its subsidiaries and authorized distributors provide product or system options for further investigation by users having technical expertise.
- The user, through its own analysis and testing, is solely responsible for making the final selection of the system and components and assuring that all performance, endurance, maintenance, safety and warning requirements of the application are met. The user must analyze all aspects of the application, follow applicable industry standards, and follow the information concerning the product in the current product catalog and in any other materials provided from Parker or its subsidiaries or authorized distributors.
- To the extent that Parker or its subsidiaries or authorized distributors provide component or system options based upon data or specifications provided by the user, the user is responsible for determining that such data and specifications are suitable and sufficient for all applications and reasonably foreseeable uses of the components or systems.

To maintain peak performance, always use genuine Parker Village Marine replacement parts. We reserve the right to change our specifications or standards without notice.

 **WARNING:** This product can expose you to chemicals including Di(2-ethylhexyl) phthalate (DEHP), which is known to the state of California to cause cancer and birth defects or other reproductive harm. For more information go to www.P65Warnings.ca.gov.

Maintenance Kits

PRO MINI - MAINTENANCE KIT			
	Qty	Part Number	Description
B675220002 Includes	6	33-0117	ELEMENT PREFILTER 10/05
	1	0804743278	SCREEN MESH 3/8 SEA STRAI
	2	2614010473	ORING BLUE HSG 237
	2	2614100278	ORING SEA STRAINER 3/8 SQ
	3	0803004773	ELEMENT CHARCOAL 10"L NON
	1	B645800001	MCC-1 ALKALINE CLEANER
	1	B645800002	MCC-2 ACID CLEANER
	1	B645800003	CLEANING STORAGE BOTTLE
	1	85-0050	OIL PMP 16OZ

AQUA MATIC - MAINTENANCE KIT W/DUAL PRE-FILTER ASSY			
	Qty	Part Number	Description
B675120001 Includes	6	0801130257	ELEMENT PREFILTER 10/25
	6	33-0117	ELEMENT PREFILTER 10/05
	3	0803004773	ELEMENT CHARCOAL 10"L NON
	2	B646800001	MCC - CLEANING KIT MCC 1 & 2
	2	B645800002	MCC-2 ACID CLEANER
	1	B645800003	CLEANING STORAGE BOTTLE
	1	08251950AS	ELEMENT PH 9-3/4L
	1	85-0050	OIL PMP 16OZ
	3	2614015800	ORING GAUGE/PRES SWITCH 0

AQUA PRO - MAINTENANCE KIT AW CPFE/OWS 32.5			
	Qty	Part Number	Description
B675800003 Includes	2	0801063357	ELEMENT CPFE 5MIC 32.5 SQ
	1	08020723KD	ELEMENT OWSE 32.5SQFT
	3	0803004773	ELEMENT CHARCOAL 10"L NON
	2	B646800001	MCC - CLEANING KIT MCC 1 & 2
	2	B645800002	MCC-2 ACID CLEANER
	1	85-0050	OIL PMP 16OZ
	1	B645800003	CLEANING STORAGE BOTTLE

AQUA MATIC XL Kit			
	Qty	Part Number	Description
61012013 Includes	6	0801063357	ELEMENT CPFE 5MIC
	3	08020723KD	Oil Water Separator
	6	0801133257	ELEMENT CPFE 20MIC
	4	07620310WA-06	O-Ring CPF/OWS 32.5 Sq. Ft
	1	2625130172	SEAL/SEAT BOOSTER PMP HP75
	3	85-0050	Pump Oil
	6	B646800001	MCC 1 & 2 Cleaning Kit
	3	B645800003	Storage Chemical
	3	0803004773	Charcoal Filter
	1	08251950AS	Ph Neutralizer Element
	1	0805823578	Plankton Filter

AQUA PRO - MAINTENANCE KIT AW DUAL PREFILTER			
	Qty	Part Number	Description
B675800002 Includes	6	33-0117	ELEMENT PREFILTER 10/05
	6	0801130257	ELEMENT PREFILTER 10/25
	3	0803004773	ELEMENT CHARCOAL 10"L NON
	3	2614010473	ORING BLUE HSG 237
	2	B646800001	MCC - CLEANING KIT MCC 1 & 2
	2	B645800002	MCC-2 ACID CLEANER
	1	B645800003	CLEANING STORAGE BOTTLE
	1	85-0050	OIL PMP 16OZ

SRC MEMBRANES	
Production/ Day	Membrane Required:
450-1	2724011233 x1
700-1	2724011333 x1
900-1	2724011433 x1
900-2	2724011233 x2
1400-2	2724011333 x2
1800-2	2724011433 x2

AQUA MATIC - MAINTENANCE KIT AQM WITH CPFE/OWS 32.5			
	Qty	Part Number	Description
B675120002 Includes	2	0801063357	ELEMENT CPFE 5MIC 32.5 SQ
	1	08020723KD	ELEMENT OWSE 32.5SQFT
	3	0803004773	ELEMENT CHARCOAL 10"L NON
	1	08251950AS	ELEMENT PH 9-3/4L
	2	B646800001	MCC - CLEANING KIT MCC 1 & 2
	1	B645800003	CLEANING STORAGE BOTTLE
	1	85-0050	OIL PMP 16OZ
	3	2614015800	ORING GAUGE/PRES SWITCH 0

WARNING: This product can expose you to chemicals including Di(2-ethylhexyl) phthalate (DEHP), which is known to the state of California to cause cancer and birth defects or other reproductive harm. For more information go to www.P65Warnings.ca.gov.

Maintenance Kits

KIT,CRUISE,LWM 145/200 GP		
Qty	Part Number	Description
1	85-0050	OIL, PLUNGER PUMP, PER 1 QUART
6	33-0117	FILTER,PLT,5 MIC,10.0" LG
1	33-0311	FILTER,CARBON,5 MIC,2.5" X10"
1	90-0005	O-RING, FILTER HOUSING, 10 SQF
1	99-6880	WRENCH,FILTER,10 SQFT HOUSING,
2	90-2512	KIT, O-RING, 2.5" PRESSURE VES
2	85-0102	KIT, CLEANING, FILTER CARTRIDG
1	85-0103	KIT,PRESERVATIVE,FILTER CARTRI
4	32-2116	O-RING,END PLUG PRODUCT TUBE,
1	90-0005	O-RING, FILTER HOUSING, 10 SQF

MAINTENANCE KIT SF> VOYAGER		
Qty	Part Number	Description
2	0801063357	FILTER,PLT,5 MIC,13.0" LG
2	08020723KD	ELEMENT OWSE 32.5SQFT
3	0803004773	ELEMENT CHARCOAL 10"L NON-LBL
2	H41949001A	MEMBRANE CLEANING CC1 AKALINE
2	H41949002A	MEMBRANE CLEANING CC2 ACID ASS
1	H41949005A	MEMBRANE STORAGE CHEM ASSY
1	0421051239-2	ORING SEA STRAINER 3/4 RUBBER
1	0421051239-6	SCREEN MESH 3/4 MONEL BRONZE
1	85-0050	OIL, PLUNGER PUMP, PER 1 QUART
2	07620310WA-06	ORING LID 32.5SQFT CPF/OWS

KIT,CRUISE,LTM 500-800 GP		
Qty	Part Number	Description
1	85-0050	OIL, PLUNGER PUMP, PER 1 QUART
6	33-0117	FILTER,PLT,5 MIC,10.0" LG
1	33-0311	FILTER,CARBON,5 MIC,2.5" X10"
1	90-0005	O-RING, FILTER HOUSING, 10 SQF
1	99-6880	WRENCH,FILTER,10 SQFT HOUSING,
2	90-2512	KIT, O-RING, 2.5" PRESSURE VES
2	85-0102	KIT, CLEANING, FILTER CARTRIDG
1	85-0103	KIT,PRESERVATIVE,FILTER CARTRI

KIT SF CRUISER UPGRADE		
Qty	Part Number	Description
2	0801063357	FILTER,PLT,5 MIC,13.0" LG
1	08020723KD	ELEMENT OWSE 32.5SQFT
3	0803004773	ELEMENT CHARCOAL 10"L NON-LBL
2	B645800001	MCC-1 ALKALINE CLEANER
2	B645800002	MCC-2 ACID CLEANER
1	B645800003	CLEANING STORAGE BOTTLE
2	85-0050	OIL, PLUNGER PUMP, PER 1 QUART
2	07620310WA-06	ORING LID 32.5SQFT CPF/OWS

KIT,CRUISE,LTM 1000-1800		
Qty	Part Number	Description
1	85-0050	OIL, PLUNGER PUMP, PER 1 QUART
1	33-0311	FILTER,CARBON,5 MIC,2.5" X10"
1	90-0005	O-RING, FILTER HOUSING, 10 SQF
2	90-2512	KIT, O-RING, 2.5" PRESSURE VES
6	33-0052	FILTER,PLT,5 MIC,10.0" LG
1	99-0265	WRENCH, FILTER, BIG WHITE HOUS
1	33-0271	O-RING, FILTER HOUSING, BIG WH
1	90-0562	KIT,CLEAN & PRESERVE,PW UNITS

To maintain peak performance, always use genuine Parker Village Marine replacement parts. We reserve the right to change our specifications or standards without notice.

WARNING: This product can expose you to chemicals including Di(2-ethylhexyl) phthalate (DEHP), which is known to the state of California to cause cancer and birth defects or other reproductive harm. For more information go to www.P65Warnings.ca.gov.

Maintenance Kits

MAINTENANCE KIT SF CRUISER With STD 10" PF			
	Qty	Part Number	Description
B675210022	2	H41949001A	MEMBRANE CLEANING CC1 AKALINE
	2	H41949002A	MEMBRANE CLEANING CC2 ACID ASS
	1	H41949005A	MEMBRANE STORAGE CHEM ASSY
	2	2614010473	ORING BLUE HSG 237
	6	0801130257	FILTER,PLT,25 MIC,10.0" LG
	6	33-0117	FILTER,PLT,5 MIC,10.0" LG
	1	85-0050	OIL, PLUNGER PUMP, PER 1 QUART
	2	0803004773	ELEMENT CHARCOAL 10"L NON-LBL

MAINTENANCE KIT SF BASIC (For SEAFARI BASIC)			
	Qty	Part Number	Description
B675210021	6	33-0117	FILTER,PLT,5 MIC,10.0" LG
	6	0801130257	FILTER,PLT,25 MIC,10.0" LG
	2	2614010473	ORING BLUE HSG 237
	2	B645800001	MCC-1 ALKALINE CLEANER
	2	B645800002	MCC-2 ACID CLEANER
	1	B645800003	CLEANING STORAGE BOTTLE
	1	85-0050	OIL, PLUNGER PUMP, PER 1 QUART

KIT,CRUISE,PW400 GPD			
	Qty	Part Number	Description
99-0140	2	33-0005	FILTER,PLT,5 MIC,8.0" LG
	1	33-0311	FILTER,CARBON,5 MIC,2.5" X10"
	2	32-2228	O-RING,END PLUG,2.5" PV
	4	32-2116	O-RING,END PLUG PRODUCT TUBE,
	1	30-0405	O-RING,FILTER HOUSING,30SQFT
	1	85-0036	CLEANER, #1, DETERGENT, 1 LB,
	1	85-0037	CLEANER, #2, SCALE REMOVER, 1
	1	85-0038	PRESERVATIVE,#3,600G,1 LB JAR
	1	70-6174	#N/A
	1	90-0005	O-RING, FILTER HOUSING, 10 SQF
	2	85-0050	OIL, PLUNGER PUMP, PER 1 QUART

KIT,CRUISE,PW800-2000 GPD			
	Qty	Part Number	Description
99-0257	2	33-0005	FILTER,PLT,5 MIC,8.0" LG
	2	33-0020	FILTER,PLT,20 MIC,8.0" LG
	1	33-0315	ELEMENT,CARBON FILTER,5X10,BIG
	4	32-2228	O-RING,END PLUG,2.5" PV
	8	32-2116	O-RING,END PLUG PRODUCT TUBE,
	1	30-0405	O-RING,FILTER HOUSING,30SQFT
	1	20-4096	PROBE,CONDUCTIVITY,5-WIRE,5'
	1	70-6184	KIT,PUMP,MANIFOLD,708-5
	1	33-0271	O-RING, FILTER HOUSING, BIG WH
	2	85-0050	OIL, PLUNGER PUMP, PER 1 QUART
	1	85-0036	CLEANER, #1, DETERGENT, 1 LB,
	1	85-0037	CLEANER, #2, SCALE REMOVER, 1
	1	85-0038	PRESERVATIVE,#3,600G,1 LB JAR

WARNING: This product can expose you to chemicals including Di(2-ethylhexyl) phthalate (DEHP), which is known to the state of California to cause cancer and birth defects or other reproductive harm. For more information go to www.P65Warnings.ca.gov.



Parker Hannifin Corporation
Bioscience Water Filtration
Division Water Purification

2630 E. El Presidio Street
Carson, CA 90810

310 608 5600

fax 310 608 5692

www.parker.com/waterpurification

Customer & Sales Support:

bwf.car.support@support.parker.com

Technical Support:

bwf.car.technical@support.parker.com