

# Operating Instructions

TDR sensor for continuous level and interface measurement of liquids

## VEGAFLEX 83

Two-wire 4 ... 20 mA/HART

PFA coated rod and cable probe



Document ID: 41834



**VEGA**

# Contents

<b>1</b>	<b>About this document</b> .....	<b>4</b>
1.1	Function .....	4
1.2	Target group .....	4
1.3	Symbols used.....	4
<b>2</b>	<b>For your safety</b> .....	<b>5</b>
2.1	Authorised personnel .....	5
2.2	Appropriate use.....	5
2.3	Warning about incorrect use.....	5
2.4	General safety instructions .....	5
2.5	EU conformity.....	6
2.6	NAMUR recommendations .....	6
2.7	Installation and operation in the USA and Canada .....	6
2.8	Environmental instructions .....	6
<b>3</b>	<b>Product description</b> .....	<b>8</b>
3.1	Configuration.....	8
3.2	Principle of operation.....	10
3.3	Packaging, transport and storage.....	12
3.4	Accessories.....	12
<b>4</b>	<b>Mounting</b> .....	<b>14</b>
4.1	General instructions .....	14
4.2	Mounting instructions .....	15
<b>5</b>	<b>Connecting to power supply</b> .....	<b>20</b>
5.1	Preparing the connection .....	20
5.2	Connecting.....	21
5.3	Wiring plan, single chamber housing.....	22
5.4	Wiring plan, double chamber housing .....	23
5.5	Wiring plan, Ex-d-ia double chamber housing.....	25
5.6	Double chamber housing with VEGADIS-Adapter .....	26
5.7	Wiring plan - version IP66/IP68, 1 bar .....	27
5.8	Supplementary electronics.....	27
5.9	Switch-on phase.....	27
<b>6</b>	<b>Set up with the display and adjustment module</b> .....	<b>28</b>
6.1	Insert display and adjustment module .....	28
6.2	Adjustment system .....	29
6.3	Parameter adjustment - Quick setup .....	30
6.4	Parameter adjustment - Extended adjustment.....	31
6.5	Saving the parameterisation data .....	49
<b>7</b>	<b>Setup with PACTware</b> .....	<b>50</b>
7.1	Connect the PC .....	50
7.2	Parameter adjustment with PACTware .....	50
7.3	Set up with the quick setup.....	52
7.4	Saving the parameterisation data .....	53
<b>8</b>	<b>Set up with other systems</b> .....	<b>54</b>
8.1	DD adjustment programs .....	54
8.2	Field Communicator 375, 475 .....	54

<b>9</b>	<b>Diagnostics and servicing .....</b>	<b>55</b>
9.1	Maintenance .....	55
9.2	Diagnosis memory .....	55
9.3	Status messages.....	56
9.4	Rectify faults.....	59
9.5	Exchanging the electronics module.....	62
9.6	Software update .....	63
9.7	How to proceed if a repair is necessary.....	63
<b>10</b>	<b>Dismount.....</b>	<b>64</b>
10.1	Dismounting steps.....	64
10.2	Disposal .....	64
<b>11</b>	<b>Supplement .....</b>	<b>65</b>
11.1	Technical data .....	65
11.2	Dimensions .....	75
11.3	Industrial property rights.....	80
11.4	Trademark .....	80



**Safety instructions for Ex areas**

Take note of the Ex specific safety instructions for Ex applications. These instructions are attached as documents to each instrument with Ex approval and are part of the operating instructions.

Editing status: 2020-01-24

# 1 About this document

## 1.1 Function

This instruction provides all the information you need for mounting, connection and setup as well as important instructions for maintenance, fault rectification, the exchange of parts and the safety of the user. Please read this information before putting the instrument into operation and keep this manual accessible in the immediate vicinity of the device.

## 1.2 Target group

This operating instructions manual is directed to trained personnel. The contents of this manual must be made available to the qualified personnel and implemented.

## 1.3 Symbols used



### Document ID

This symbol on the front page of this instruction refers to the Document ID. By entering the Document ID on [www.vega.com](http://www.vega.com) you will reach the document download.



**Information, note, tip:** This symbol indicates helpful additional information and tips for successful work.



**Note:** This symbol indicates notes to prevent failures, malfunctions, damage to devices or plants.



**Caution:** Non-observance of the information marked with this symbol may result in personal injury.



**Warning:** Non-observance of the information marked with this symbol may result in serious or fatal personal injury.



**Danger:** Non-observance of the information marked with this symbol results in serious or fatal personal injury.



### Ex applications

This symbol indicates special instructions for Ex applications.



### List

The dot set in front indicates a list with no implied sequence.



### Sequence of actions

Numbers set in front indicate successive steps in a procedure.



### Battery disposal

This symbol indicates special information about the disposal of batteries and accumulators.

## 2 For your safety

### 2.1 Authorised personnel

All operations described in this documentation must be carried out only by trained, qualified personnel authorised by the plant operator.

During work on and with the device, the required personal protective equipment must always be worn.

### 2.2 Appropriate use

VEGAFLEX 83 is a sensor for continuous level measurement.

You can find detailed information about the area of application in chapter "*Product description*".

Operational reliability is ensured only if the instrument is properly used according to the specifications in the operating instructions manual as well as possible supplementary instructions.

### 2.3 Warning about incorrect use

Inappropriate or incorrect use of this product can give rise to application-specific hazards, e.g. vessel overflow through incorrect mounting or adjustment. Damage to property and persons or environmental contamination can result. Also, the protective characteristics of the instrument can be impaired.

### 2.4 General safety instructions

This is a state-of-the-art instrument complying with all prevailing regulations and directives. The instrument must only be operated in a technically flawless and reliable condition. The operator is responsible for the trouble-free operation of the instrument. When measuring aggressive or corrosive media that can cause a dangerous situation if the instrument malfunctions, the operator has to implement suitable measures to make sure the instrument is functioning properly.

During the entire duration of use, the user is obliged to determine the compliance of the necessary occupational safety measures with the current valid rules and regulations and also take note of new regulations.

The safety instructions in this operating instructions manual, the national installation standards as well as the valid safety regulations and accident prevention rules must be observed by the user.

For safety and warranty reasons, any invasive work on the device beyond that described in the operating instructions manual may be carried out only by personnel authorised by the manufacturer. Arbitrary conversions or modifications are explicitly forbidden. For safety reasons, only the accessory specified by the manufacturer must be used.

To avoid any danger, the safety approval markings and safety tips on the device must also be observed.

## 2.5 EU conformity

The device fulfils the legal requirements of the applicable EU directives. By affixing the CE marking, we confirm the conformity of the instrument with these directives.

The EU conformity declaration can be found on our homepage.

### Electromagnetic compatibility

Instruments in four-wire or Ex-d-ia version are designed for use in an industrial environment. Nevertheless, electromagnetic interference from electrical conductors and radiated emissions must be taken into account, as is usual with class A instruments according to EN 61326-1. If the instrument is used in a different environment, the electromagnetic compatibility to other instruments must be ensured by suitable measures.

## 2.6 NAMUR recommendations

NAMUR is the automation technology user association in the process industry in Germany. The published NAMUR recommendations are accepted as the standard in field instrumentation.

The device fulfils the requirements of the following NAMUR recommendations:

- NE 21 – Electromagnetic compatibility of equipment
- NE 43 – Signal level for fault information from measuring transducers
- NE 53 – Compatibility of field devices and display/adjustment components
- NE 107 – Self-monitoring and diagnosis of field devices

For further information see [www.namur.de](http://www.namur.de).

## 2.7 Installation and operation in the USA and Canada

This information is only valid for USA and Canada. Hence the following text is only available in the English language.

Installations in the US shall comply with the relevant requirements of the National Electrical Code (ANSI/NFPA 70).

Installations in Canada shall comply with the relevant requirements of the Canadian Electrical Code

A Class 2 power supply unit has to be used for the installation in the USA and Canada.

## 2.8 Environmental instructions

Protection of the environment is one of our most important duties. That is why we have introduced an environment management system with the goal of continuously improving company environmental protection. The environment management system is certified according to DIN EN ISO 14001.

Please help us fulfil this obligation by observing the environmental instructions in this manual:

- Chapter "*Packaging, transport and storage*"
- Chapter "*Disposal*"

## 3 Product description

### 3.1 Configuration

#### Scope of delivery

The scope of delivery encompasses:

- Sensor VEGAFLEX 83
- Optional accessory
- Optionally integrated Bluetooth module

The further scope of delivery encompasses:

- Documentation
  - Quick setup guide VEGAFLEX 83
  - Instructions for optional instrument features
  - Ex-specific "*Safety instructions*" (with Ex versions)
  - If necessary, further certificates



#### Information:

Optional instrument features are also described in this operating instructions manual. The respective scope of delivery results from the order specification.

#### Scope of this operating instructions

This operating instructions manual applies to the following instrument versions:

- Hardware from 1.0.0
- Software from 1.3.0
- Only for instrument versions without SIL qualification

#### Type label

The type label contains the most important data for identification and use of the instrument:



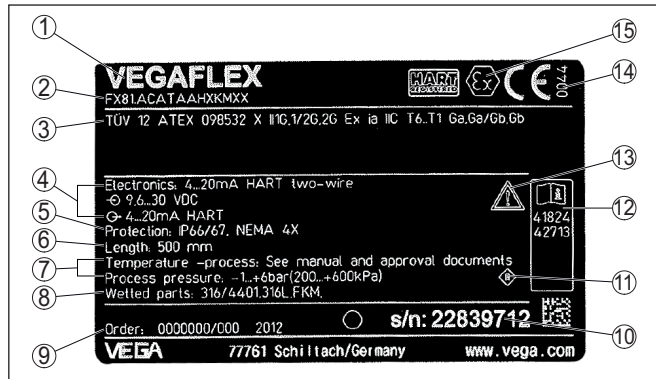

Fig. 1: Layout of the type label (example)

- 1 Instrument type
- 2 Product code
- 3 Approvals
- 4 Power supply and signal output, electronics
- 5 Protection rating
- 6 Probe length (measurement accuracy optional)
- 7 Process and ambient temperature, process pressure
- 8 Material wetted parts
- 9 Order number
- 10 Serial number of the instrument
- 11 Symbol of the device protection class
- 12 ID numbers, instrument documentation
- 13 Reminder to observe the instrument documentation
- 14 Notified authority for CE marking
- 15 Approval directives

**Serial number - Instrument search**

The type label contains the serial number of the instrument. With it you can find the following instrument data on our homepage:

- Product code (HTML)
- Delivery date (HTML)
- Order-specific instrument features (HTML)
- Operating instructions and quick setup guide at the time of shipment (PDF)
- Order-specific sensor data for an electronics exchange (XML)
- Test certificate (PDF) - optional

Move to "[www.vega.com](http://www.vega.com)" and enter in the search field the serial number of your instrument.

Alternatively, you can access the data via your smartphone:

- Download the VEGA Tools app from the "Apple App Store" or the "Google Play Store"
- Scan the DataMatrix code on the type label of the instrument or
- Enter the serial number manually in the app

### 3.2 Principle of operation

#### Application area

The VEGAFLEX 83 is a level sensor with coated cable or rod probe for continuous level or interface measurement, particularly suitable for applications in the chemical industry.

#### Functional principle - level measurement

High frequency microwave pulses are guided along a steel cable or a rod. Upon reaching the product surface, the microwave pulses are reflected. The running time is evaluated by the instrument and output as level.

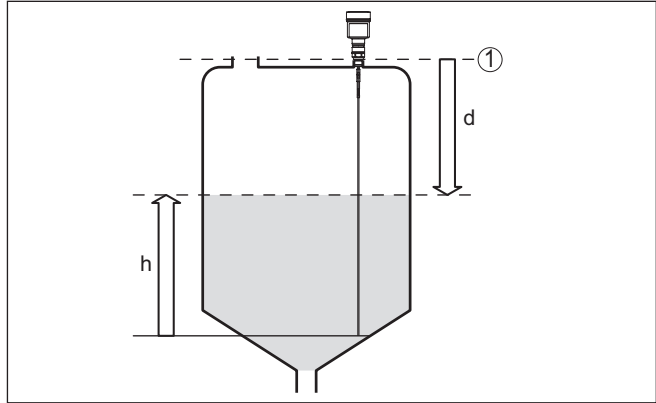

Fig. 2: Level measurement

- 1 Sensor reference plane (seal surface of the process fitting)
- d Distance to the level
- h Height - Level

#### Functional principle - interface measurement

High frequency microwave impulses are guided along a steel cable or rod. Upon reaching the product surface, a part of the microwave impulses is reflected. The other part passes through the upper product and is reflected by the interface. The running times to the two product layers are processed by the instrument.

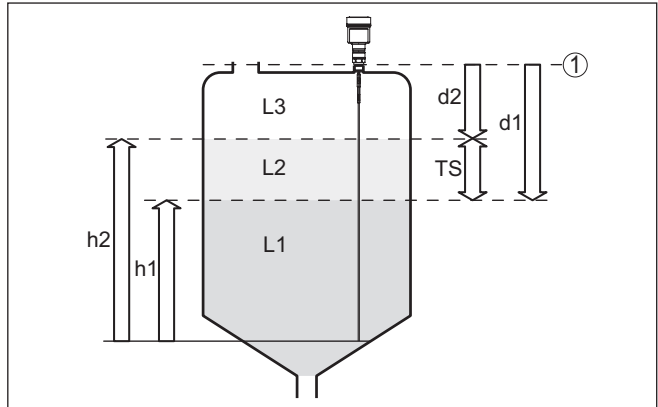

Fig. 3: Interface measurement

- 1 Sensor reference plane (seal surface of the process fitting)
- d1 Distance to the interface
- d2 Distance to the level
- TS Thickness of the upper medium ( $d1 - d2$ )
- h1 Height - Interface
- h2 Height - Level
- L1 Lower medium
- L2 Upper medium
- L3 Gas phase

**Prerequisites for interface measurement**

**Upper medium (L2)**

- The upper medium must not be conductive
- The dielectric constant of the upper medium or the actual distance to the interface must be known (input required). Min. dielectric constant: 1.6. You can find a list of dielectric constants on our home page: [www.vega.com](http://www.vega.com).
- The composition of the upper medium must be stable, no varying products or mixtures
- The upper medium must be homogeneous, no stratifications within the medium
- Min. thickness of the upper medium 50 mm (1.97 in)
- Clear separation from the lower medium, emulsion phase or detritus layer max. 50 mm (1.97 in)
- If possible, no foam on the surface

**Lower medium (L1)**

- The dielectric constant must be 10 higher than the dielectric constant of the upper medium, preferably electrically conductive. Example: upper medium dielectric constant 2, lower medium at least dielectric constant 12.

**Gas phase (L3)**

- Air or gas mixture
- Gas phase - dependent on the application, gas phase does not always exist ( $d2 = 0$ )

**Output signal** The instrument is always preset to the application "*Level measurement*".  
For the interface measurement, you can select the requested output signal with the setup.

### 3.3 Packaging, transport and storage

**Packaging** Your instrument was protected by packaging during transport. Its capacity to handle normal loads during transport is assured by a test based on ISO 4180.

The packaging consists of environment-friendly, recyclable cardboard. For special versions, PE foam or PE foil is also used. Dispose of the packaging material via specialised recycling companies.

**Transport** Transport must be carried out in due consideration of the notes on the transport packaging. Nonobservance of these instructions can cause damage to the device.

**Transport inspection** The delivery must be checked for completeness and possible transit damage immediately at receipt. Ascertained transit damage or concealed defects must be appropriately dealt with.

**Storage** Up to the time of installation, the packages must be left closed and stored according to the orientation and storage markings on the outside.  
Unless otherwise indicated, the packages must be stored only under the following conditions:

- Not in the open
- Dry and dust free
- Not exposed to corrosive media
- Protected against solar radiation
- Avoiding mechanical shock and vibration

**Storage and transport temperature**

- Storage and transport temperature see chapter "*Supplement - Technical data - Ambient conditions*"
- Relative humidity 20 ... 85 %

**Lifting and carrying** With instrument weights of more than 18 kg (39.68 lbs) suitable and approved equipment must be used for lifting and carrying.

### 3.4 Accessories

The instructions for the listed accessories can be found in the download area on our homepage.

**PLICSCOM** The display and adjustment module is used for measured value indication, adjustment and diagnosis.

The integrated Bluetooth module (optional) enables wireless adjustment via standard adjustment devices.

**VEGACONNECT** The interface adapter VEGACONNECT enables the connection of communication-capable instruments to the USB interface of a PC.

<b>VEGADIS 81</b>	The VEGADIS 81 is an external display and adjustment unit for VEGA plics® sensors.
<b>VEGADIS adapter</b>	The VEGADIS adapter is an accessory part for sensors with double chamber housings. It enables the connection of VEGADIS 81 to the sensor housing via an M12 x 1 plug.
<b>VEGADIS 82</b>	VEGADIS 82 is suitable for measured value indication and adjustment of sensors with HART protocol. It is looped into the 4 ... 20 mA/HART signal cable.
<b>PLICSMOBILE T81</b>	The PLICSMOBILE T81 is an external GSM/GPRS/UMTS radio unit for transmission of measured values and for remote parameter adjustment of HART sensors.
<b>PLICSMOBILE 81</b>	PLICSMOBILE 81 is an internal GSM/GPRS/UMTS radio unit for HART sensors for transmitting measured values and for remote parameterization.
<b>Protective cover</b>	The protective cover protects the sensor housing against soiling and intense heat from solar radiation.
<b>Flanges</b>	Screwed flanges are available in different versions according to the following standards: DIN 2501, EN 1092-1, BS 10, ASME B 16.5, JIS B 2210-1984, GOST 12821-80.
<b>Display and adjustment module with heating</b>	<p>The display and adjustment module can be optionally replaced by a display and adjustment module with heating function.</p> <p>You can use this display and adjustment module in an ambient temperature range of -40 ... +70 °C.</p>
<b>External housing</b>	<p>If the standard sensor housing is too big or in case of strong vibrations, an external housing can be used.</p> <p>Then the sensor housing is made of stainless steel. The electronics is located in the external housing which can be mounted in a distance of up to 10 m (32.8 ft) to the sensor by using a connection cable.</p>
<b>Centering</b>	If you mount the VEGAFLEX 83 in a bypass tube or standpipe, you have to avoid contact to the bypass tube by using a spacer at the probe end.

## 4 Mounting

### 4.1 General instructions

#### Protection against moisture

Protect your instrument against moisture ingress through the following measures:

- Use a suitable connection cable (see chapter "*Connecting to power supply*")
- Tighten the cable gland or plug connector
- Lead the connection cable downward in front of the cable entry or plug connector

This applies mainly to outdoor installations, in areas where high humidity is expected (e.g. through cleaning processes) and on cooled or heated vessels.



#### Note:

Make sure that the degree of contamination specified in chapter "*Technical data*" meets the existing ambient conditions.



#### Note:

Make sure that during installation or maintenance no moisture or dirt can get inside the instrument.

To maintain the housing protection, make sure that the housing lid is closed during operation and locked, if necessary.

#### Cable glands

##### Metric threads

In the case of instrument housings with metric thread, the cable glands are screwed in at the factory. They are sealed with plastic plugs as transport protection.

You have to remove these plugs before electrical connection.

##### NPT thread

In the case of instrument housings with self-sealing NPT threads, it is not possible to have the cable entries screwed in at the factory. The free openings for the cable glands are therefore covered with red dust protection caps as transport protection. The dust protection caps do not provide sufficient protection against moisture.

Prior to setup you have to replace these protective caps with approved cable glands or close the openings with suitable blind plugs.

#### Process conditions



#### Note:

For safety reasons, the instrument must only be operated within the permissible process conditions. You can find detailed information on the process conditions in chapter "*Technical data*" of the operating instructions or on the type label.

Hence make sure before mounting that all parts of the instrument exposed to the process are suitable for the existing process conditions.

These are mainly:

- Active measuring component
- Process fitting
- Process seal

Process conditions in particular are:

- Process pressure
- Process temperature
- Chemical properties of the medium
- Abrasion and mechanical influences

## Installation position

### 4.2 Mounting instructions

Mount VEGAFLEX 83 in such a way that the distance to vessel installations or to the vessel wall is at least 300 mm (12 in). In non-metallic vessels, the distance to the vessel wall should be at least 500 mm (19.7 in).

During operation, the probe must not touch any installations or the vessel wall. If necessary, fasten the probe end.

In vessels with conical bottom it can be advantageous to mount the sensor in the center of the vessel, as measurement is then possible nearly down to the lowest point of the bottom. Keep in mind that measurement all the way down to the tip of the probe may not be possible. The exact value of the min. distance (lower dead zone) is stated in chapter "Technical data" of the operating instructions.

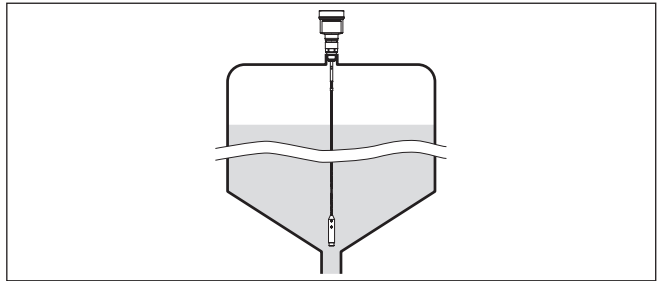

Fig. 4: Vessel with conical bottom

## Type of vessel

### Plastic vessel/Glass vessel

The guided microwave principle requires a metallic surface on the process fitting. Therefore, in plastic vessels, etc., use an instrument version with flange (from DN 50) or place a metal sheet ( $\varnothing > 200$  mm/8 in) beneath the process fitting when screwing it in.

Make sure that the plate has direct contact with the process fitting.

When mounting rod or cable probes in vessels without metal walls, e.g. in plastic vessels, the measured value can be influenced by strong electromagnetic fields (emitted interference according to EN 61326: class A). In this case, use a probe with coaxial version.

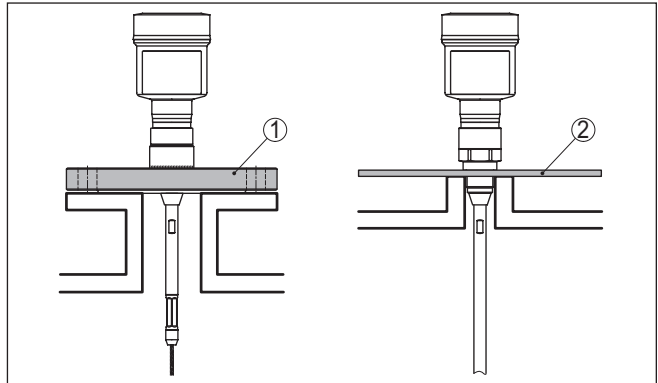

Fig. 5: Mounting in non-metallic vessel

- 1 Flange
- 2 Metal sheet

### Mounting socket

If possible, avoid sockets. Mount the sensor flush with the vessel top. If this is not possible, use short sockets with small diameter.

Higher sockets or sockets with a bigger diameter can generally be used. They can, however, increase the upper dead zone. Check if this is relevant for your measurement.

In such cases, always carry out a false signal suppression after mounting. You can find further information under "Setup procedure".

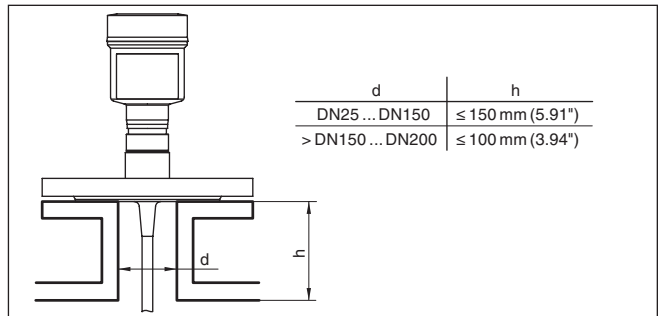

Fig. 6: Mounting socket

When welding the socket, make sure that the socket is flush with the vessel top.



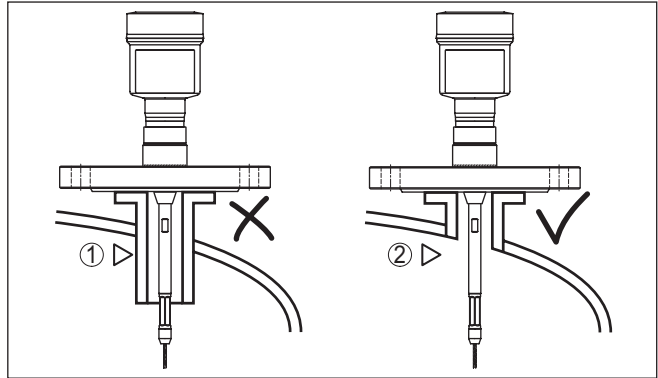

Fig. 7: Socket must be installed flush

- 1 Unfavourable mounting
- 2 Socket flush - optimum mounting

**Welding work**

Before beginning the welding work, remove the electronics module from the sensor. By doing this, you avoid damage to the electronics through inductive coupling.

**Inflowing medium**

Do not mount the instruments in or above the filling stream. Make sure that you detect the product surface, not the inflowing product.

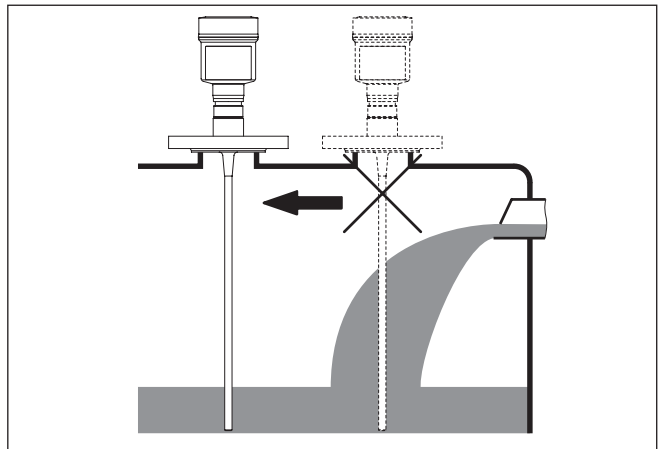

Fig. 8: Mounting of the sensor with inflowing medium

**Measuring range**

The reference plane for the measuring range of the sensors is the sealing surface of the thread or flange.

Keep in mind that a min. distance must be maintained below the reference plane and possibly also at the end of the probe - measurement in these areas is not possible (dead zone). The length of the cable can be used all the way to the end only when measuring conductive

products. These dead zones for different mediums are listed in chapter "*Technical data*". Keep in mind for the adjustment that the default setting for the measuring range refers to water.

### Pressure

The process fitting must be sealed if there is gauge or low pressure in the vessel. Before use, check if the seal material is resistant against the measured product and the process temperature.

The max. permissible pressure is specified in chapter "*Technical data*" or on the type label of the sensor.

### Lateral installation

In case of difficult installation conditions, the probe can also be mounted laterally. For this, adapt the rod with rod extensions or angled segments.

To compensate for the resulting changes in signal runtime, let the instrument determine the probe length automatically.

The determined probe length can deviate from the actual probe length when using curved or angled segments.

If internal installations such as struts, ladders, etc. are present on the vessel wall, the measuring probe should be mounted at least 300 mm (11.81 in) away from the vessel wall.

You can find further information in the supplementary instructions of the rod extension.

### Rod extension

In case of difficult installation conditions, for example in a socket, the probe can be suitably adapted with a rod extension.

To compensate for the resulting changes in signal runtime, let the instrument determine the probe length automatically.

You can find further information in the supplementary instructions of the rod and cable components.

### Torque with PTFE plated flanges

The PTFE washer of the antenna encapsulation serves also as process seal.

To compensate the normal prestress loss due to the seal materials, you have to use also disc springs in addition to the flange screws for fastening PTFE plated flanges.

We recommend flexible retaining washers (e.g. Schnorr VS or S) or detent edged rings (e.g. Gross VS KD).

Suitable retaining elements are also available from us.

Size	Article no.	Type
M16, $\frac{7}{8}$ "	32880	Detent edged ring Gross VS KD
M20, $\frac{3}{4}$ "	32881	Detent edged ring Gross VS KD
M24, $\frac{5}{8}$ "	32882	Retaining washer Schnorr VS, Schnorr S

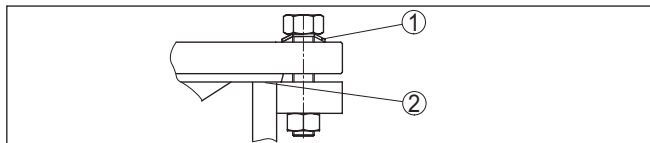

Fig. 9: Use of disc springs

- 1 Single disc spring
- 2 Laminated disc spring

The flange screws of VEGAFLEX 83 must be tightened with a torque of approx. 60 Nm (44 lbf ft) so that the PTFE washer seals reliably.



**Note:**

We recommend, retightening the screws in regular intervals depending on process pressure and temperature

## 5 Connecting to power supply

### 5.1 Preparing the connection

#### Safety instructions

Always keep in mind the following safety instructions:

- Carry out electrical connection by trained, qualified personnel authorised by the plant operator
- If overvoltage surges are expected, overvoltage arresters should be installed



#### Warning:

Only connect or disconnect in de-energized state.

#### Voltage supply

Power supply and current signal are carried on the same two-wire cable. The operating voltage can differ depending on the instrument version.

The data for power supply are specified in chapter "*Technical data*".

Provide a reliable separation between the supply circuit and the mains circuits according to DIN EN 61140 VDE 0140-1.

Power the instrument via an energy-limited circuit acc. to IEC 61010-1, e.g. via Class 2 power supply unit.

Keep in mind the following additional factors that influence the operating voltage:

- Lower output voltage of the power supply unit under nominal load (e.g. with a sensor current of 20.5 mA or 22 mA in case of fault)
- Influence of additional instruments in the circuit (see load values in chapter "*Technical data*")

#### Connection cable

The instrument is connected with standard two-wire cable without screen. If electromagnetic interference is expected which is above the test values of EN 61326-1 for industrial areas, screened cable should be used.

Use cable with round cross section for instruments with housing and cable gland. Use a cable gland suitable for the cable diameter to ensure the seal effect of the cable gland (IP protection rating).

We generally recommend the use of shielded cable for HART multidrop mode.

#### Cable glands

##### Metric threads

In the case of instrument housings with metric thread, the cable glands are screwed in at the factory. They are sealed with plastic plugs as transport protection.



#### Note:

You have to remove these plugs before electrical connection.

##### NPT thread

In the case of instrument housings with self-sealing NPT threads, it is not possible to have the cable entries screwed in at the factory. The free openings for the cable glands are therefore covered with red dust protection caps as transport protection.

**Note:**

Prior to setup you have to replace these protective caps with approved cable glands or close the openings with suitable blind plugs.

On plastic housings, the NPT cable gland or the Conduit steel tube must be screwed into the threaded insert without grease.

Max. torque for all housings, see chapter "*Technical data*".

**Cable screening and grounding**

If screened cable is required, we recommend connecting the cable screening on both ends to ground potential. In the sensor, the cable screening must be connected directly to the internal ground terminal. The ground terminal on the outside of the housing must be connected to the ground potential (low impedance).



In Ex systems, the grounding is carried out according to the installation regulations.

In electroplating plants as well as plants for cathodic corrosion protection it must be taken into account that significant potential differences exist. This can lead to unacceptably high currents in the cable screen if it is grounded at both ends.

**Note:**

The metallic parts of the instrument (process fitting, sensor, concentric tube, etc.) are connected with the internal and external ground terminal on the housing. This connection exists either directly via the conductive metallic parts or, in case of instruments with external electronics, via the screen of the special connection cable.

You can find specifications on the potential connections inside the instrument in chapter "*Technical data*".

**5.2 Connecting****Connection technology**

The voltage supply and signal output are connected via the spring-loaded terminals in the housing.

Connection to the display and adjustment module or to the interface adapter is carried out via contact pins in the housing.

**Information:**

The terminal block is pluggable and can be removed from the electronics. To do this, lift the terminal block with a small screwdriver and pull it out. When reinserting the terminal block, you should hear it snap in.

**Connection procedure**

Proceed as follows:

1. Unscrew the housing lid
2. If a display and adjustment module is installed, remove it by turning it slightly to the left
3. Loosen compression nut of the cable gland and remove blind plug
4. Remove approx. 10 cm (4 in) of the cable mantle, strip approx. 1 cm (0.4 in) of insulation from the ends of the individual wires
5. Insert the cable into the sensor through the cable entry

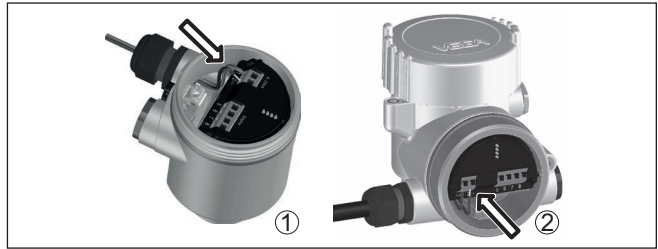

Fig. 10: Connection steps 5 and 6

- 1 Single chamber housing
- 2 Double chamber housing

6. Insert the wire ends into the terminals according to the wiring plan



**Note:**

Solid cores as well as flexible cores with wire end sleeves are inserted directly into the terminal openings. In case of flexible cores without end sleeves, press the terminal from above with a small screwdriver, the terminal opening is then free. When the screwdriver is released, the terminal closes again.

7. Check the hold of the wires in the terminals by lightly pulling on them
8. Connect the screen to the internal ground terminal, connect the external ground terminal to potential equalisation
9. Tighten the compression nut of the cable entry gland. The seal ring must completely encircle the cable
10. Reinsert the display and adjustment module, if one was installed
11. Screw the housing lid back on

The electrical connection is finished.

### 5.3 Wiring plan, single chamber housing



The following illustration applies to the non-Ex, Ex-ia and Ex-d version.

**Electronics and connection compartment**

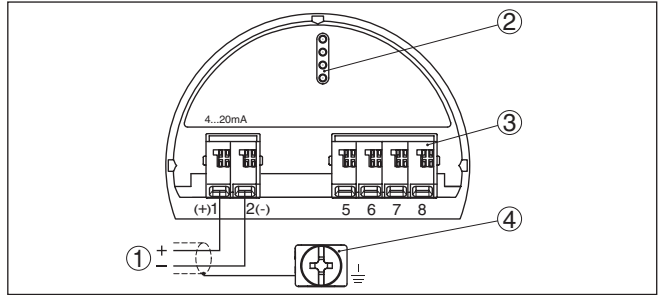

Fig. 11: Electronics and connection compartment - single chamber housing

- 1 Voltage supply, signal output
- 2 For display and adjustment module or interface adapter
- 3 For external display and adjustment unit
- 4 Ground terminal for connection of the cable screening

**5.4 Wiring plan, double chamber housing**



The following illustration applies to the non-Ex, Ex-ia and Ex-d version.

**Electronics compartment**

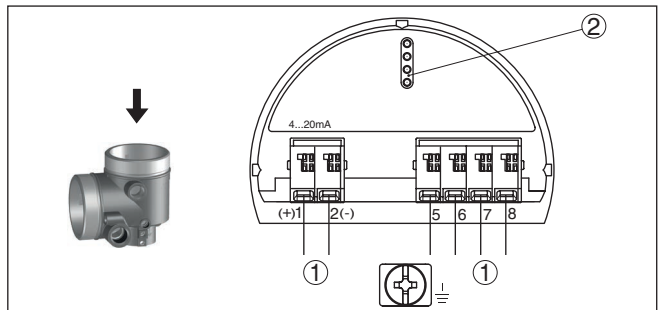

Fig. 12: Electronics compartment - double chamber housing

- 1 Internal connection to the connection compartment
- 2 For display and adjustment module or interface adapter

## Connection compartment

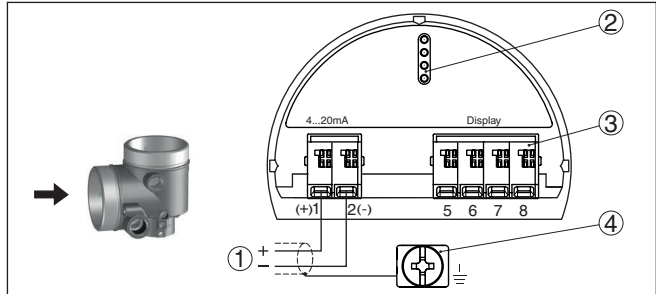

Fig. 13: Connection compartment - double chamber housing

- 1 Voltage supply, signal output
- 2 For display and adjustment module or interface adapter
- 3 For external display and adjustment unit
- 4 Ground terminal for connection of the cable screening

**Connection compartment - Radio module  
PLICSMOBILE 81**

Fig. 14: Connection compartment - Radio module PLICSMOBILE 81

- 1 Voltage supply

You can find detailed information for connection in the operating instructions "PLICSMOBILE".

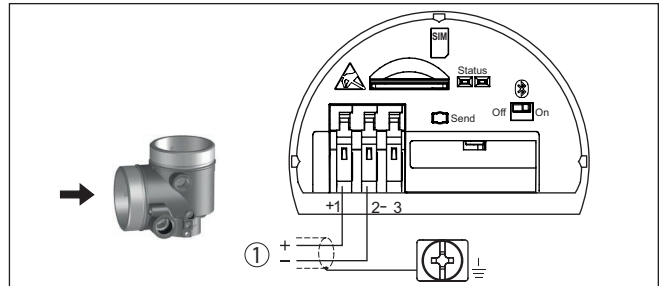

### 5.5 Wiring plan, Ex-d-ia double chamber housing

#### Electronics compartment

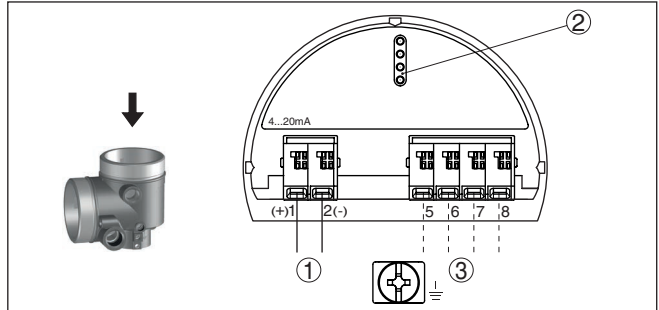

Fig. 15: Electronics compartment - Ex-d-ia double chamber housing

- 1 Internal connection to the connection compartment
- 2 For display and adjustment module or interface adapter
- 3 Internal connection to the plug connector for external display and adjustment unit (optional)



**Note:**

HART multidrop mode is not possible when using an Ex-d-ia instrument.

#### Connection compartment

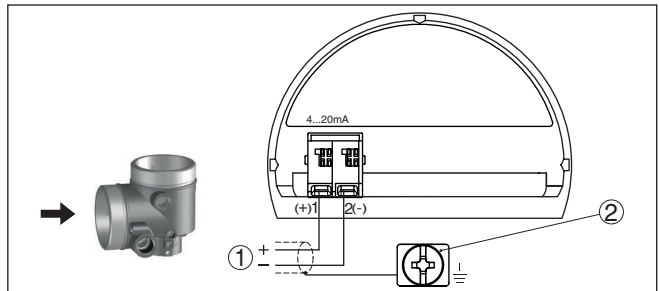

Fig. 16: Connection compartment - Ex-d-ia double chamber housing

- 1 Voltage supply, signal output
- 2 Ground terminal for connection of the cable screening

## 5.6 Double chamber housing with VEGADIS-Adapter

### Electronics compartment

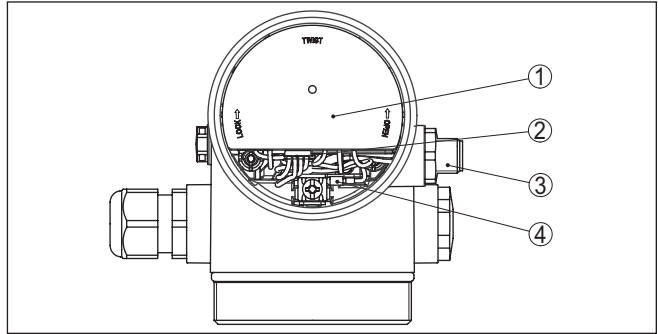

Fig. 17: View to the electronics compartment with VEGADIS adapter for connection of the external display and adjustment unit

- 1 VEGADIS adapter
- 2 Internal plug connection
- 3 M12 x 1 plug connector

### Assignment of the plug connector

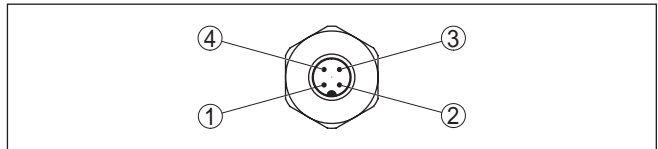

Fig. 18: View to the plug connector M12 x 1

- 1 Pin 1
- 2 Pin 2
- 3 Pin 3
- 4 Pin 4

Contact pin	Colour, connection cable in the sensor	Terminal, electronics module
Pin 1	Brown	5
Pin 2	White	6
Pin 3	Blue	7
Pin 4	Black	8

**Wire assignment, connection cable**

**5.7 Wiring plan - version IP66/IP68, 1 bar**

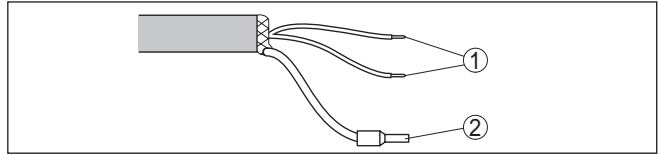

Fig. 19: Wire assignment in permanently connected connection cable

- 1 Brown (+) and blue (-) to power supply or to the processing system
- 2 Shielding

**Supplementary electronics - Additional current output**

**5.8 Supplementary electronics**

To make a second measured value available for use, you can use the supplementary electronics "Additional current output".

Both current outputs are passive and need a power supply.

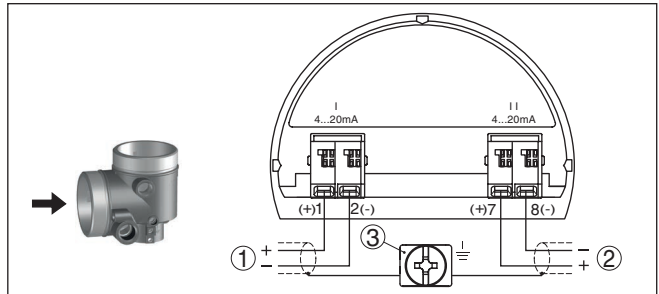

Fig. 20: Terminal compartment, double chamber housing, supplementary electronics "Additional current output"

- 1 First current output (I) - Voltage supply and signal output, sensor (HART)
- 2 Additional current output (II) - Voltage supply and signal output (without HART)
- 3 Ground terminal for connection of the cable screening

**5.9 Switch-on phase**

After connection of the device to power supply, the device first carries out a self-test:

- Internal check of the electronics
- Indication of the status message "F 105 Determine measured value" on the display or PC
- The output signal jumps briefly to the set fault current

Then the actual measured value is output to the signal cable. The value takes into account settings that have already been carried out, e.g. default setting.

## 6 Set up with the display and adjustment module

### 6.1 Insert display and adjustment module

The display and adjustment module can be inserted into the sensor and removed again at any time. You can choose any one of four different positions - each displaced by 90°. It is not necessary to interrupt the power supply.

Proceed as follows:

1. Unscrew the housing lid
2. Place the display and adjustment module on the electronics in the desired position and turn it to the right until it snaps in.
3. Screw housing lid with inspection window tightly back on

Disassembly is carried out in reverse order.

The display and adjustment module is powered by the sensor, an additional connection is not necessary.



Fig. 21: Installing the display and adjustment module in the electronics compartment of the single chamber housing

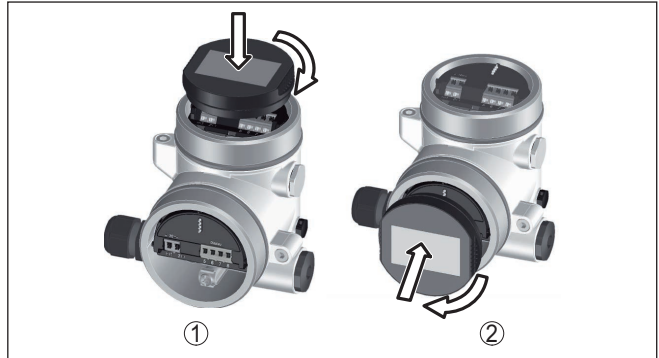

Fig. 22: Installing the display and adjustment module in the double chamber housing

- 1 In the electronics compartment
- 2 In the connection compartment



**Note:**

If you intend to retrofit the instrument with a display and adjustment module for continuous measured value indication, a higher lid with an inspection glass is required.

**6.2 Adjustment system**

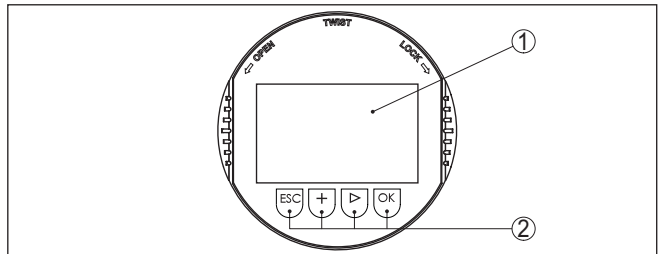

Fig. 23: Display and adjustment elements

- 1 LC display
- 2 Adjustment keys

**Key functions**

- **[OK]** key:
  - Move to the menu overview
  - Confirm selected menu
  - Edit parameter
  - Save value
- **[>]** key:
  - Change measured value presentation
  - Select list entry
  - Select editing position
- **[+]** key:
  - Change value of the parameter

- **[ESC]** key:
  - Interrupt input
  - Jump to next higher menu

### Adjustment system

The sensor is operated via the four keys of the display and adjustment module. The individual menu items are shown on the LC display. You can find the function of the individual keys in the previous illustration.

When the **[+]** and **[->]** keys are pressed quickly, the edited value, or the cursor, changes one value or position at a time. If the key is pressed longer than 1 s, the value or position changes continuously.

When the **[OK]** and **[ESC]** keys are pressed simultaneously for more than 5 s, the display returns to the main menu. The menu language is then switched over to "English".

Approx. 60 minutes after the last pressing of a key, an automatic reset to measured value indication is triggered. Any values not confirmed with **[OK]** will not be saved.

### Switch-on phase

After switching on, the VEGAFLEX 83 carries out a short self-test where the device software is checked.

The output signal transmits a fault signal during the switch-on phase.

The following information is displayed on the display and adjustment module during the startup procedure:

- Instrument type
- Device name
- Software version (SW-Ver)
- Hardware version (HW-Ver)

### Measured value indication

With the **[->]** key you can move between three different indication modes.

In the first view, the selected measured value is displayed in large digits.

In the second view, the selected measured value and a corresponding bar graph presentation are displayed.

In the third view, the selected measured value as well as a second selectable value, e.g. the temperature, are displayed.



## 6.3 Parameter adjustment - Quick setup

### Quick setup

To quickly and easily adapt the sensor to the application, select the menu item "Quick setup" in the start graphic on the display and adjustment module.

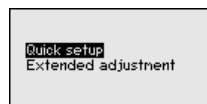

The following steps for the quick setup can be reached also in the "Extended adjustment".

- Instrument address
- Measurement loop name
- Medium type (optional)
- Application
- Max. adjustment
- Min. adjustment
- False signal suppression

You can find the description of the individual menu items in the following chapter "Parameter adjustment - Extended adjustment".

### 6.4 Parameter adjustment - Extended adjustment

For technically demanding measuring points, you can carry out extended settings in "Extended adjustment".



#### Main menu

The main menu is divided into five sections with the following functions:

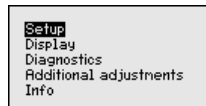

**Setup:** Settings, e.g. measurement loop name, medium, vessel, adjustment, signal output, device unit, false signal suppression, linearization curve

**Display:** Settings, e.g., for language, measured value display, lighting

**Diagnosis:** Information, e.g. on instrument status, pointer, measurement reliability, simulation, echo curve

**Additional adjustments:** Reset, date/time, reset, copy function

**Info:** Instrument name, hardware and software version, date of manufacture, instrument features



#### Note:

For optimum adjustment of the measuring point, the individual sub-menu items in the main menu item "Setup" should be selected one after the other and provided with the correct parameters. If possible, go through the items in the given sequence.

The procedure is described below.

The following submenu points are available:

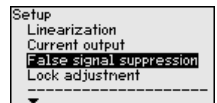
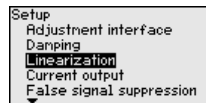
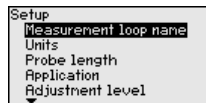

The submenu points are described below.

### 6.4.1 Setup

**Measurement loop name** Here you can assign a suitable measurement loop name. Push the "OK" key to start the editing. With the "+" key you change the sign and with the "->" key you jump to the next position.

You can enter names with max. 19 characters. The character set comprises:

- Capital letters from A ... Z
- Numbers from 0 ... 9
- Special characters + - / \_ blanks

Measurement loop name  
TANK 04

#### Units

In this menu item you select the distance unit and the temperature unit.

Distance unit  
mm

Temperature unit  
°C

For the distance units you can choose between m, mm and ft and for the temperature units °C, °F and K.

#### Probe length

In this menu item you can enter the probe length or have the length determined automatically by the sensor system.

When choosing "Yes", then the probe length will be determined automatically. When choosing "No", you can enter the probe length manually.

Probe length  
1000 mm

Probe length  
determine automatically?  
Yes  
No

Probe length  
1000  
mm  
0 80000

#### Application - Medium type

In this menu item you can select which type of medium you want to measure. You can choose between liquid or bulk solid.

Application  
Type of medium  
Application  
Medium/Dielectric figure

Type of medium  
Liquid

Type of medium  
✓ Liquid  
Solid

#### Application - Application

In this menu item, you can select the application. You can choose between level measurement and interface measurement. You can also choose between measurement in a vessel or in a bypass or standpipe.



#### Note:

The selection of the application has a considerable influence on all other menu items. Keep in mind that as you continue with the parameter adjustment, individual menu items are only optionally available.



You have the option of choosing the demonstration mode. This mode is only suitable for test and demonstration purposes. In this mode, the sensor ignores the parameters of the application and reacts immediately to any change.

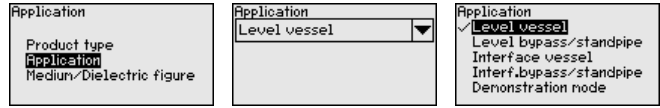

**Application - Medium, dielectric constant**

In this menu item, you can define the type of medium (product).

This menu item is only available if you have selected level measurement under the menu item "Application".

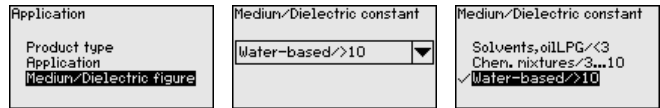

You can choose between the following medium types:

Dielectric constant	Type of medium	Examples
> 10	Water-based liquids	Acids, alcalis, water
3 ... 10	Chemical mixtures	Chlorobenzene, nitro lacquer, aniline, isocyanate, chloroform
< 3	Hydrocarbons	Solvents, oils, liquid gas

**Application - Gas phase**

This menu item is only available, if you have chosen interface measurement under the menu item "Application". In this menu item you can enter if there is a superimposed gas phase in your application.

Only set the function to "Yes", if the gas phase is permanently present.

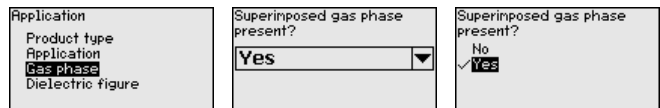

**Application - Dielectric constant**

This menu item is only available if you have selected interface measurement under the menu item "Application". In this menu item you can enter the dielectric constant of the upper medium.

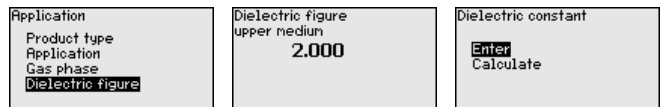

You can directly enter the dielectric constant of the upper medium or have the value determined by the instrument.

If you want the dielectric constant to be determined by the instrument, you have to enter the measured or known distance to the interface.

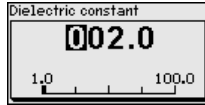
**Max. adjustment level**

In this menu item you can enter the max. adjustment for the level. With interface measurement this is the maximum total level.

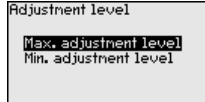

Adjust the requested percentage value with **[+]** and store with **[OK]**.

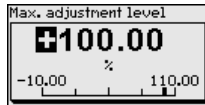

Enter the appropriate distance value in m (corresponding to the percentage value) for the full vessel. The distance refers to the sensor reference plane (seal surface of the process fitting). Keep in mind that the max. level must lie below the dead zone.

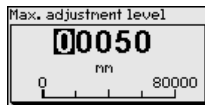
**Min. adjustment level**

In this menu item you can enter the min. adjustment for the level. With interface measurement this is the minimum total level.

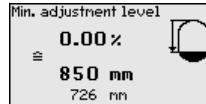
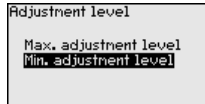

Adjust the requested percentage value with **[+]** and store with **[OK]**.

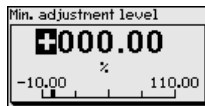

Enter the suitable distance value in m for the empty vessel (e.g. distance from the flange to the probe end) corresponding to the percentage value. The distance refers to the sensor reference plane (seal surface of the process fitting).

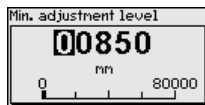

**Max. adjustment interface** This menu item is only available if you have selected interface measurement under the menu item "Application".



Enter the requested percentage value for the max. adjustment.

As an alternative, you have the possibility taking over the adjustment of the level measurement also for the interface.

Enter the respective distance value in m for the surface of the upper medium corresponding to the percentage value.

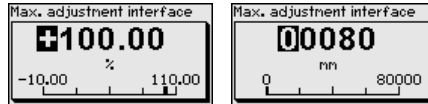

**Min. adjustment interface**

This menu item is only available if you have selected interface measurement under the menu item "Application".

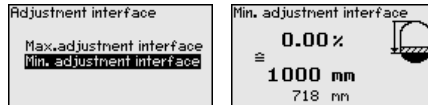

Enter the requested percentage value for the min. adjustment (interface).

Enter the respective distance value in m for the interface corresponding to the percentage value of the interface.

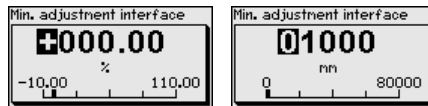

**Damping**

To damp process-dependent measured value fluctuations, set an integration time of 0 ... 999 s in this menu item.

If you have selected interface measurement under the menu item "Application", you can adjust the damping for the level and the interface separately.

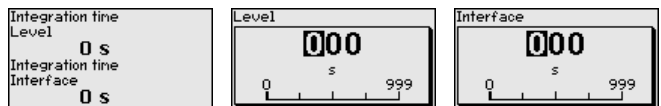

The default setting is a damping of 0 s.

**Linearisation**

A linearisation is necessary for all vessels in which the vessel volume does not increase linearly with the level - e.g. a horizontal cylindrical or spherical tank, when the indication or output of the volume is required. Corresponding linearisation curves are preprogrammed for these vessels. They represent the correlation between the level percentage and vessel volume.

The linearisation applies to the measured value indication and the current output. By activating the appropriate curve, the volume per-

centage of the vessel is displayed correctly. If the volume should not be displayed in percent but e.g. in l or kg, a scaling can be also set in the menu item "Display".

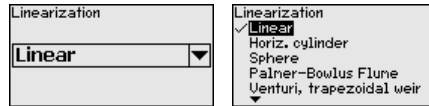

### Warning:

If a linearisation curve is selected, the measuring signal is no longer necessarily linear to the filling height. This must be considered by the user especially when setting the switching point on the limit signal transmitter.

In the following, you have to enter the values for your vessel, for example the vessel height and the socket correction.

For non-linear vessel forms, enter the vessel height and the socket correction.

For the vessel height, you have to enter the total height of the vessel.

For the socket correction you have to enter the height of the socket above the upper edge of the vessel. If the socket is lower than the upper edge of the vessel, this value can also be negative.

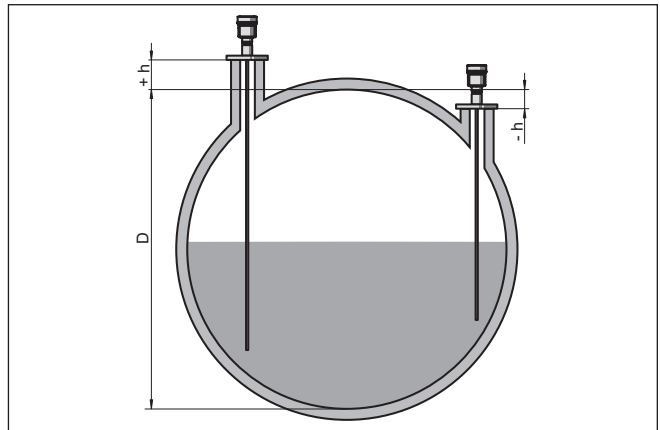
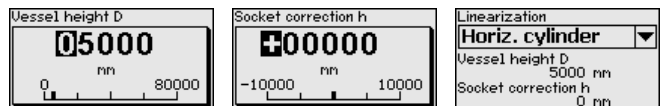

Fig. 24: Vessel height and socket correction value

$D$  Vessel height

$+h$  Positive socket correction value

$-h$  Negative socket correction value



### Current output mode

In the menu item "Current output mode" you determine the output characteristics and reaction of the current output in case of fault.

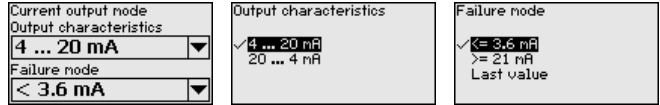

The default setting is output characteristics 4 ... 20 mA, fault mode < 3.6 mA.

**Current output, min./max.** In the menu item "Current output Min./Max.", you determine the reaction of the current output during operation.



The default setting is min. current 3.8 mA and max. current 20.5 mA.

**False signal suppression** The following circumstances cause interfering reflections and can influence the measurement:

- High mounting sockets
- Vessel internals such as struts



**Note:**

A false signal suppression detects, marks and saves these false signals so that they are no longer taken into account for the level and interface measurement. We generally recommend carrying out a false signal suppression to achieve the best possible accuracy. This should be done with the lowest possible level so that all potential interfering reflections can be detected.

Proceed as follows:

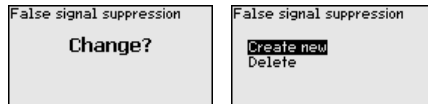

Select first if the probe is covered or uncovered.

If the probe is covered, enter the actual distance from the sensor to the product surface.

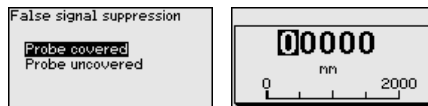

All interfering signals in this section are detected by the sensor and stored.

Keep in mind that with covered probe only false signals in the uncovered area of the probe are detected.



**Note:**

Check the distance to the product surface, because if an incorrect (too large) value is entered, the existing level will be saved as a false signal. The level would then no longer be detectable in this area.

If a false signal suppression has already been created in the sensor, the following menu window appears when selecting "*False signal suppression*":



The instrument carries out an automatic false signal suppression as soon as the probe is uncovered. The false signal suppression is always updated.

The menu item "*Delete*" is used to completely delete an already created false signal suppression. This is useful if the saved false signal suppression no longer matches the metrological conditions in the vessel.

### Lock/Unlock adjustment

In the menu item "*Lock/unlock adjustment*", you can protect the sensor parameters against unauthorized or inadvertent modification. The PIN is activated/deactivated permanently.

With active PIN, only the following adjustment functions are possible without entering a PIN:

- Select menu items and show data
- Read data from the sensor into the display and adjustment module

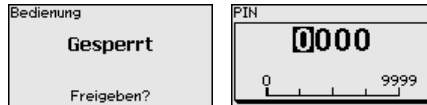

#### Caution:

When the PIN is active, adjustment via PACTware/DTM as well as other systems is also blocked.

In delivery status, the PIN is **0000**.

Call our service department if you have modified and forgotten the PIN.

### Current output 2

If a supplementary electronics with an additional current output is installed in the instrument, you can adjust the additional current output separately.

In menu item "*Current output 2*" you specify which measured value the additional current output refers to.

The procedure corresponds to the previous settings of the standard current output. See "*Setup - Current output*".

### 6.4.2 Display

#### Display

In the main menu point "*Display*", the individual submenu points should be selected one after the other and provided with the correct parameters to ensure the optimum adjustment of the display options. The procedure is described in the following.

The following submenu points are available:

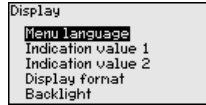

The submenu points are described below.

**Menu language**

This menu item enables the setting of the requested national language.

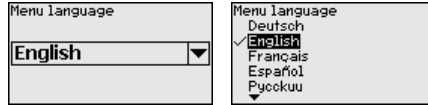

In delivery status, the sensor is set to English.

**Displayed value 1**

In this menu item, you define the indication of the measured value on the display. You can display two different measured values. In this menu item, you define measured value 1.

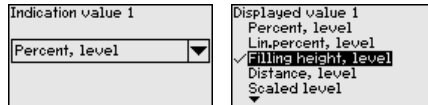

The default setting for the displayed value 1 is "Filling height Level".

**Displayed value 2**

In this menu item, you define the indication of the measured value on the display. You can display two different measured values. In this menu item, you define measured value 2.

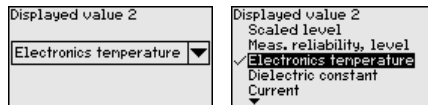

The default setting for the displayed value 2 is the electronics temperature.

**Display format**

In this menu item, you define the display format of the measured value on the display. You can define different display formats for the two measured values.

You can thus define the number of decimal positions the measured value is displayed with.

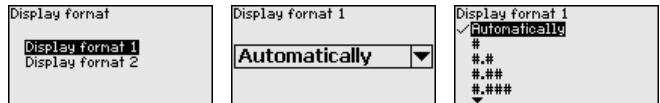

The default setting for the display format is "Automatic".

**Backlight**

The integrated background lighting can be switched off via the adjustment menu. The function depends on the strength of the supply voltage, see "Technical data".

To maintain the function of the device, the lighting is temporarily switched off if the power supply is insufficient.



In delivery status, the lighting is switched on.

### 6.4.3 Diagnostics

#### Sensor status

In this menu item, the device status is displayed.

When the instrument displays a failure message, you can here get detailed information on the failure reason.

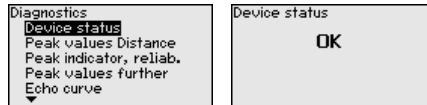

#### Peak values, distance

The respective min. and max. measured value is saved in the sensor. The two values are displayed in the menu item "*Peak values, distance*".

If you have selected interface measurement under the menu item "*Setup - Application*", the peak values of the interface measurement are displayed in addition to the peak values of the level measurement.

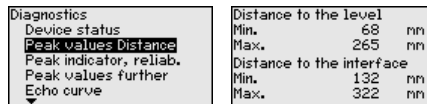

In another window you can carry out a reset of the two peak values separately.

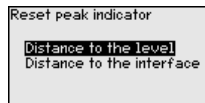

#### Peak values, measurement reliability

The respective min. and max. measured values are saved in the sensor. The two values are displayed in the menu item "*Peak values, measurement reliability*".

The measurement can be influenced by the process conditions. In this menu item, the measurement reliability of the level measurement is displayed in mV. The higher the value, the more reliable the measurement.

If you have selected interface measurement under the menu item "*Setup - Application*", the peak values of the interface measurement are displayed in addition to the peak values of the level measurement.

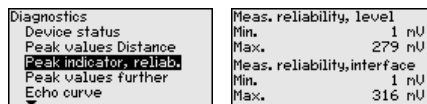

In another window you can carry out a reset of the two peak values separately.



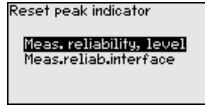

**Peak values, additional**

The respective min. and max. measured values are saved in the sensor. The values are displayed in the menu item "*Peak values Additional*".

This menu item displays the peak values of the electronics temperature as well as the dielectric constant.

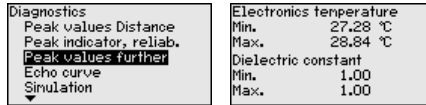

In another window you can carry out a reset of the two peak values separately.

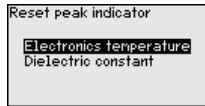

**Information:**

If one of the display values flashes, there is actually no valid value available.

**Echo curve**

The menu item "*Echo curve*" shows the signal strength of the echoes over the measuring range in V. The signal strength enables an evaluation of the quality of the measurement.

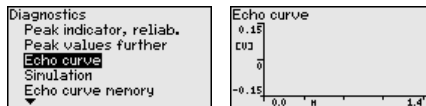

With the following functions you can zoom part sections of the echo curve.

- "X-Zoom": Zoom function for the meas. distance
- "Y-Zoom": 1, 2, 5 and 10x signal magnification in "V"
- "Unzoom": Reset the presentation to the nominal measuring range without magnification

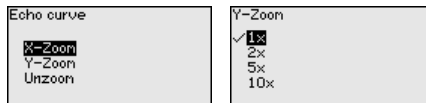

**Simulation**

In this menu item you can simulate measured values via the current output. This allows the signal path to be tested, e.g. through downstream indicating instruments or the input card of the control system.

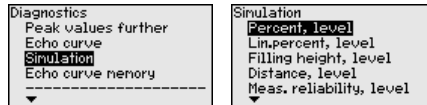

Select the requested simulation variable and set the requested value.

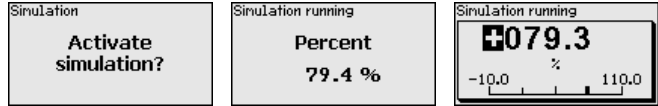

#### Caution:

During simulation, the simulated value is output as 4 ... 20 mA current value and digital HART signal.

Push the **[ESC]** key to deactivate the simulation.



#### Information:

The simulation is terminated automatically 60 minutes after the activation of the simulation.

## Echo curve memory

With the menu item "*Setup*" the echo curve it is possible to save at the time of setup. This is generally recommended; for using the Asset Management functions it is necessary. If possible, the curve should be saved with a low level in the vessel.

With this, you can detect signal changes over the operating time. With the adjustment software PACTware and the PC, the high-resolution echo curve can be displayed and used to compare the echo curve of the setup with the actual echo curve.

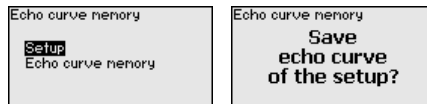

The function "*Echo curve memory*" enables storing echo curves of the measurement.

Under the sub-menu item "*Echo curve memory*" you can store the current echo curve.

Parameter settings for recording the echo curve and the settings of the echo curve itself can be carried out in the adjustment software PACTware.

With the adjustment software PACTware and the PC the high-resolution echo curve can be displayed and used later on to assess the quality of the measurement.

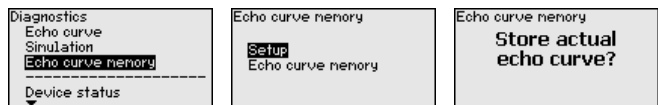

### 6.4.4 Additional adjustments

#### Date/Time

In this menu item, the internal clock of the sensor is set.

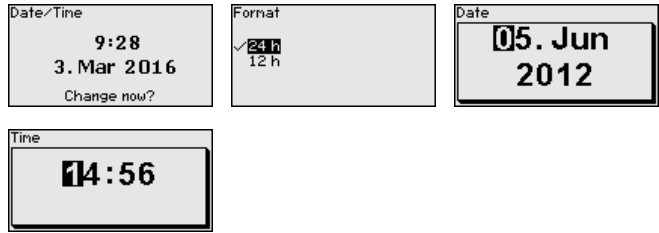

**Reset**

After a reset, certain parameter adjustments made by the user are reset.



**Note:**

After this menu window, the reset process is carried out. No further safety inquiry follows.



The following reset functions are available:

**Delivery status:** Restores the parameter settings at the time of shipment from the factory, incl. order-specific settings. Any stored false signal suppression or user-programmed linearisation curve, as well as the measured value memory, are deleted.

**Basic settings:** Restores the parameter settings, incl. special parameters, to the default values of the respective instrument. Any stored false signal suppression or user-programmed linearisation curve, as well as the measured value memory, are deleted.

The following table shows the default values of the instrument. Depending on the instrument version or application, all menu items may not be available or some may be differently assigned:

**Menu - Setup**

Menu item	Default value
Lock adjustment	Released
Measurement loop name	Sensor
Units	Distance unit: order-specific Temperature unit: order-specific
Probe length	Länge der Messsonde factory setting
Type of medium	Liquid
Application	Level, vessel
Medium, dielectric constant	Water-based, > 10
Superimposed gas phase	Yes
Dielectric constant, upper medium (TS)	1.5
Tube inner diameter	200 mm

Menu item	Default value
Max. adjustment - Level	100 % Distance: 0.000 m(d) - Note dead zones
Min. adjustment - Level	0 % Distance: Probe length - Note dead zones
Max. adjustment - Interface	100 % Distance: 0.000 m(d) - Note dead zones
Min. adjustment - Interface	0 % Distance: Probe length - Note dead zones
Damping - Level	0.0 s
Damping - Interface	0.0 s
Linearisation type	Linear
Linearisation - Socket correction	0 mm
Linearisation - Vessel height	Probe length
Scaling variable - Level	Volume in l
Scaling unit - Level	Litres
Scaling format - Level	Without decimal positions
Scaling level - 100 % corresponds to	100
Scaling level - 0 % corresponds to	0
Scaling variable - Interface	Volume
Scaling unit - Interface	Litres
Scaling format - Interface	Without decimal positions
Scaling interface - 100 % corresponds to	100
Scaling interface - 0 % corresponds to	0
Current output, output variable	Lin. percent - Level
Current output - Output characteristics	0 ... 100 % correspond to 4 ... 20 mA
Current output - Reaction in case of fault	≤ 3.6 mA
Current output - Min.	3.8 mA
Current output - Max.	20.5 mA
Current output 2 - Output variable	Distance - Level
Current output 2 - Output characteristics	0 ... 100 % correspond to 4 ... 20 mA
Current output 2 - Reaction in case of fault	≤ 3.6 mA
Current output 2 - Min.	3.8 mA
Current output 2 - Max.	20.5 mA

### Menu - Display

Menu item	Default value
Language	Selected language
Displayed value 1	Filling height

Menu item	Default value
Displayed value 2	Electronics temperature
Display format 1	Automatically
Display format 2	Automatically
Backlight	Switched on

### Menu - Additional adjustments

Menu item	Default value
PIN	0000
Date	Actual date
Time	Actual time
Time - Format	24 hours
Probe type	Device-specific

**Copy instrument settings** The instrument settings are copied with this function. The following functions are available:

- **Read from sensor:** Read data from sensor and store into the display and adjustment module
- **Write into sensor:** Store data from the display and adjustment module back into the sensor

The following data or settings for adjustment of the display and adjustment module are saved:

- All data of the menu "Setup" and "Display"
- In the menu "Additional adjustments" the items "Reset, Date/Time"
- Special parameters

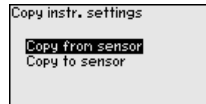
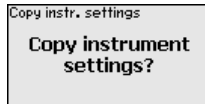

### Prerequisites

The following requirements must be met for a successful transmission:

- The data can only be transferred to the same device type, e.g. VEGAFLEX 83
- It must be the same probe type, e.g. rod probe
- The firmware of both devices is identical

The copied data are permanently saved in an EEPROM memory in the display and adjustment module and remain there even in case of power failure. From there, they can be written into one or more sensors or kept as backup for a possible electronics exchange.



### Note:

Before the data are stored in the sensor, a check is carried out to determine if the data fit the sensor. If the data do not fit, a fault signal

is triggered or the function is blocked. When data are being written into the sensor, the display shows which instrument type the data originate from and which TAG-no. this sensor had.



**Tip:**

We recommend to save the instrument adjustments. In case of an electronics exchange the saved parameter adjustment data relieve this process.

**Scaling level**

Since scaling is very extensive, scaling of the level value was divided into two menu items.

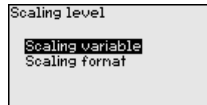

**Scaling level - Scaling prime**

In menu item "Scaling variable" you define the scaling variable and the scaling unit for the level value on the display, e.g. volume in l.

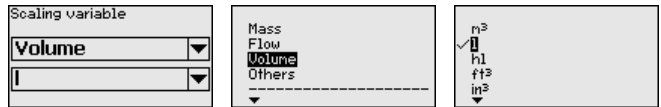

**Scaling level - Scaling format**

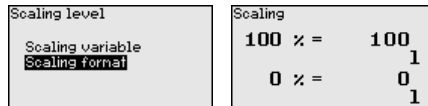

In menu item "Scaling format" you define the scaling format on the display and the scaling of the measured level value for 0 % and 100 %.

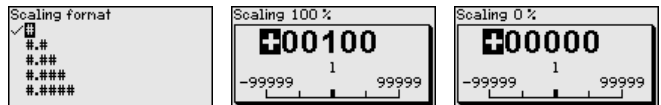

**Scaling interface**

Since scaling is very extensive, scaling of the interface value was divided into two menu items.

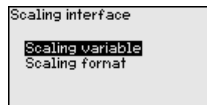

**Scaling interface - Scaling size**

In menu item "Scaling variable" you define the scaling variable and the scaling unit for the interface value on the display, e.g. volume in l.

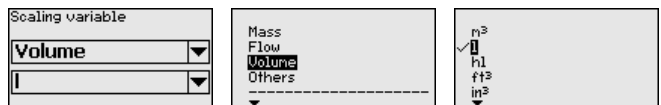

**Scaling interface - Scaling format**

In menu item "*Scaling format*" you define the scaling format on the display and the scaling of the measured interface value for 0 % and 100 %.

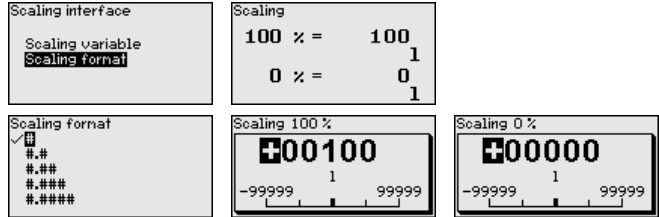

**Current output**

Since scaling is very extensive, scaling of the level value was divided into two menu items.

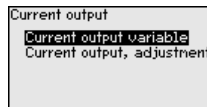

**Current output - Current output size**

In menu item "*Current output, variable*" you specify which measured variable the current output refers to.

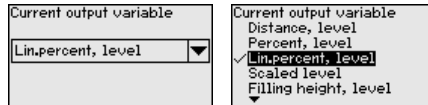

**Current output - Current output adjustment**

In menu item "*Current output, adjustment*" you can assign a respective measured value to the current output.

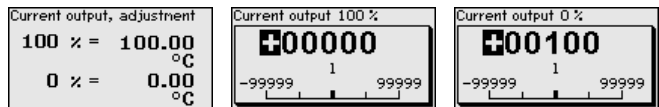

**Probe type**

In this menu item you can select the type and size of your probe from a list of all possible probes. This is necessary to adapt the electronics optimally to the probe.

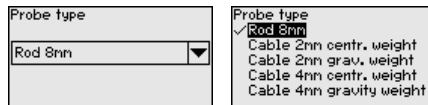

**HART mode**

The sensor offers the HART modes "*Analogue current output*" and "*Fix current (4 mA)*". In this menu item you determine the HART mode and enter the address with Multidrop mode.

In the mode "*Fixed current output*" up to 63 sensors can be operated on one two-wire cable (Multidrop operation). An address between 0 and 63 must be assigned to each sensor.

If you select the function "Analogue current output" and also enter an address number, you can output a 4 ... 20 mA signal in Multidrop mode.

In the mode "Fixed current (4 mA)" a fixed 4 mA signal is output independently of the actual level.

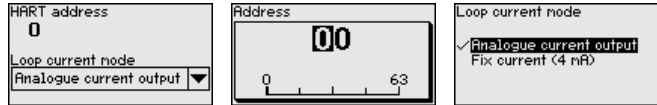

The default setting is "Analogue current output" and the address 00.

## Special parameters

In this menu item you gain access to the protected area where you can enter special parameters. In exceptional cases, individual parameters can be modified in order to adapt the sensor to special requirements.

Change the settings of the special parameters only after having contacted our service staff.



### 6.4.5 Info

#### Device name

In this menu, you read out the instrument name and the instrument serial number.

#### Instrument version

In this menu item, the hardware and software version of the sensor is displayed.

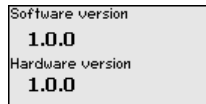

#### Factory calibration date

In this menu item, the date of factory calibration of the sensor as well as the date of the last change of sensor parameters are displayed via the display and adjustment module or via the PC.

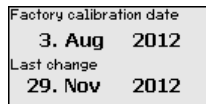

#### Sensor characteristics

In this menu item, the features of the sensor such as approval, process fitting, seal, measuring range, electronics, housing and others are displayed.

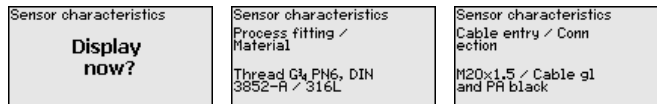

Example for displayed sensor features.



## 6.5 Saving the parameterisation data

### On paper

We recommended writing down the adjustment data, e.g. in this operating instructions manual, and archiving them afterwards. They are thus available for multiple use or service purposes.

### In the display and adjustment module

If the instrument is equipped with a display and adjustment module, the parameter adjustment data can be saved therein. The procedure is described in menu item "*Copy device settings*".

## 7 Setup with PACTware

### 7.1 Connect the PC

Via the interface adapter directly on the sensor

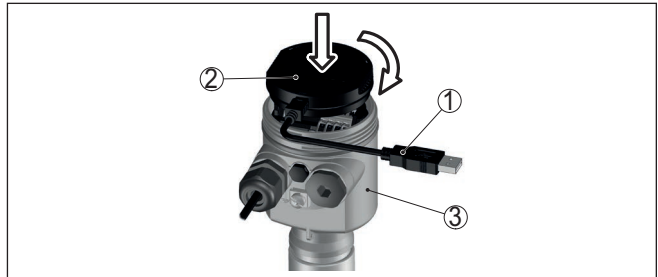

Fig. 25: Connection of the PC directly to the sensor via the interface adapter

- 1 USB cable to the PC
- 2 Interface adapter VEGACONNECT
- 3 Sensor

Via the interface adapter and HART

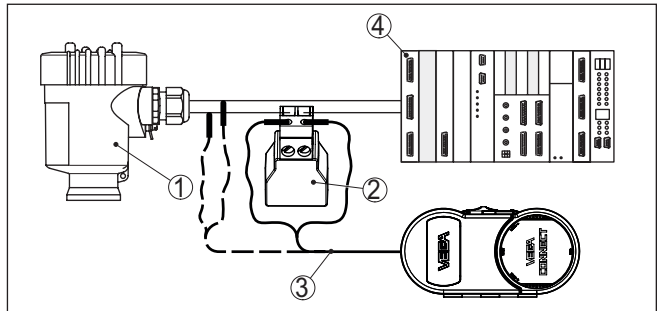

Fig. 26: Connecting the PC via HART to the signal cable

- 1 Sensor
- 2 HART resistance 250  $\Omega$  (optional depending on evaluation)
- 3 Connection cable with 2 mm pins and terminals
- 4 Processing system/PLC/Voltage supply
- 5 Interface adapter, for example VEGACONNECT 4



#### Note:

With power supply units with integrated HART resistance (internal resistance approx. 250  $\Omega$ ), an additional external resistance is not necessary. This applies, e.g. to the VEGA instruments VEGATRENN 149A, VEGAMET 381, VEGAMET 391. Common Ex separators are also usually equipped with a sufficient current limiting resistance. In such cases, the interface converter can be connected parallel to the 4 ... 20 mA cable (dashed line in the previous illustration).

### 7.2 Parameter adjustment with PACTware

#### Prerequisites

For parameter adjustment of the sensor via a Windows PC, the configuration software PACTware and a suitable instrument driver (DTM)

according to FDT standard are required. The up-to-date PACTware version as well as all available DTMs are compiled in a DTM Collection. The DTMs can also be integrated into other frame applications according to FDT standard.



**Note:**

To ensure that all instrument functions are supported, you should always use the latest DTM Collection. Furthermore, not all described functions are included in older firmware versions. You can download the latest instrument software from our homepage. A description of the update procedure is also available in the Internet.

Further setup steps are described in the operating instructions manual "DTM Collection/PACTware" attached to each DTM Collection and which can also be downloaded from the Internet. Detailed descriptions are available in the online help of PACTware and the DTMs.

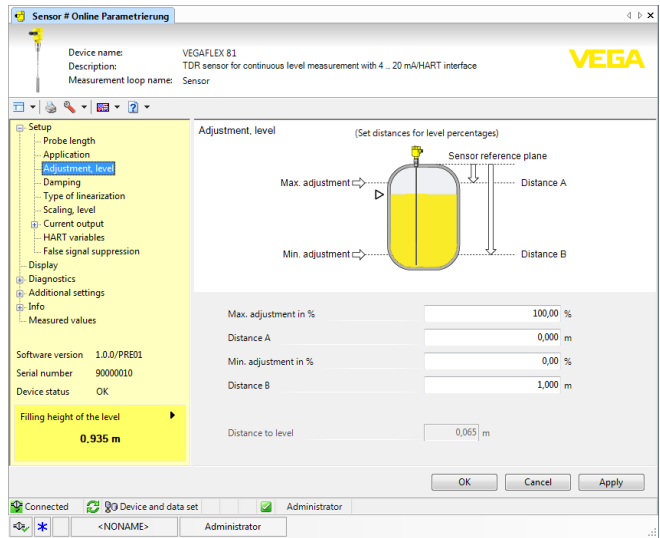

Fig. 27: Example of a DTM view

**Standard/Full version**

All device DTMs are available as a free-of-charge standard version and as a full version that must be purchased. In the standard version, all functions for complete setup are already included. An assistant for simple project configuration simplifies the adjustment considerably. Saving/printing the project as well as import/export functions are also part of the standard version.

In the full version there is also an extended print function for complete project documentation as well as a save function for measured value and echo curves. In addition, there is a tank calculation program as well as a multiviewer for display and analysis of the saved measured value and echo curves.

The standard version is available as a download under [www.vega.com/downloads](http://www.vega.com/downloads) and "Software". The full version is available on CD from the agency serving you.

### 7.3 Set up with the quick setup

#### General information

The quick setup is another option for parameter adjustment of the sensor. It allows fast, convenient adjustment of the most important parameters to adapt the sensor quickly to standard applications. To use it, select the function "Quick setup" in the start screen.

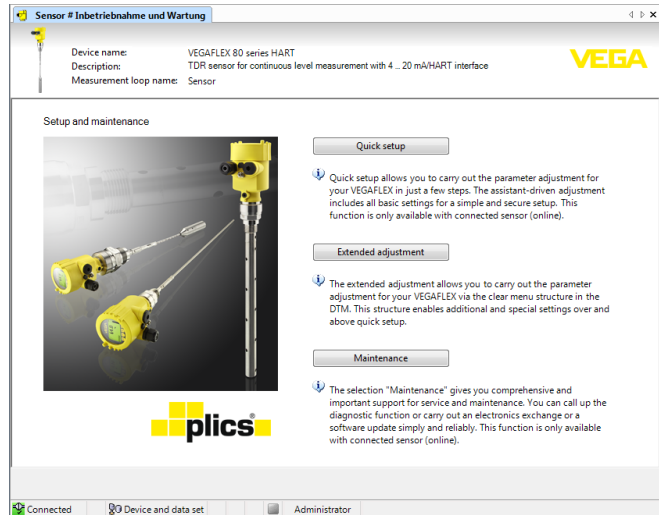

Fig. 28: Select quick setup

- 1 Quick setup
- 2 Extended adjustment
- 3 Maintenance

#### Quick setup

With quick setup you can carry out the parameter adjustment of VEGAFLEX 83 for your application in just a few simple steps. The assistant-driven adjustment includes the basic settings for simple, reliable setup and commissioning.



#### Information:

If the function is inactive, then possibly no instrument is connected. Check the connection to the instrument.

#### Extended adjustment

With the extended adjustment, you carry out the parameter adjustment for the instrument via the clear menu structure in the DTM (Device Type Manager). This enables additional and special settings over and above those offered by quick setup.

**Maintenance**

Under the menu item "*Maintenance*" you get comprehensive and important support for servicing and maintenance. You can call up diagnostic functions and carry out an electronics exchange or a software update.

**Start quick setup**

Click to the button "*Quick setup*", to start the assistant-driven adjustment for a simplified and reliable setup.

**7.4 Saving the parameterisation data**

We recommend documenting or saving the parameterisation data via PACTware. That way the data are available for multiple use or service purposes.

## 8 Set up with other systems

### 8.1 DD adjustment programs

Device descriptions as Enhanced Device Description (EDD) are available for DD adjustment programs such as, for example, AMS† and PDM.

The files can be downloaded at [www.vega.com/downloads](http://www.vega.com/downloads) under "Software".

### 8.2 Field Communicator 375, 475

Device descriptions for the instrument are available as EDD for parameterisation with Field Communicator 375 or 475.

Integrating the EDD into the Field Communicator 375 or 475 requires the "Easy Upgrade Utility" software, which is available from the manufacturer. This software is updated via the Internet and new EDDs are automatically accepted into the device catalogue of this software after they are released by the manufacturer. They can then be transferred to a Field Communicator.

## 9 Diagnostics and servicing

### 9.1 Maintenance

#### Maintenance

If the device is used properly, no special maintenance is required in normal operation.

#### Cleaning

The cleaning helps that the type label and markings on the instrument are visible.

Take note of the following:

- Use only cleaning agents which do not corrode the housings, type label and seals
- Use only cleaning methods corresponding to the housing protection rating

### 9.2 Diagnosis memory

The instrument has several memories available for diagnostic purposes. The data remain there even in case of voltage interruption.

#### Measured value memory

Up to 100,000 measured values can be stored in the sensor in a ring memory. Each entry contains date/time as well as the respective measured value. Storable values are for example:

- Distance
- Filling height
- Percentage value
- Lin. percent
- Scaled
- Current value
- Measurement reliability
- Electronics temperature

When the instrument is shipped, the measured value memory is active and stores distance, measurement reliability and electronics temperature every 3 minutes.

In "Extended adjustment" you can select the respective measured values.

The requested values and recording conditions are set via a PC with PACTware/DTM or the control system with EDD. Data are thus read out and also reset.

#### Event memory

Up to 500 events are automatically stored with a time stamp in the sensor (non-deletable). Each entry contains date/time, event type, event description and value. Event types are for example:

- Modification of a parameter
- Switch-on and switch-off times
- Status messages (according to NE 107)
- Error messages (according to NE 107)

The data are read out via a PC with PACTware/DTM or the control system with EDD.

## Echo curve memory

The echo curves are stored with date and time and the corresponding echo data. The memory is divided into two sections:

**Echo curve of the setup:** This is used as reference echo curve for the measurement conditions during setup. Changes in the measurement conditions during operation or buildup on the sensor can thus be recognized. The echo curve of the setup is stored via:

- PC with PACTware/DTM
- Control system with EDD
- Display and adjustment module

**Further echo curves:** Up to 10 echo curves can be stored in a ring buffer in this memory section. Additional echo curves are stored via:

- PC with PACTware/DTM
- Control system with EDD
- Display and adjustment module

## 9.3 Status messages

The instrument features self-monitoring and diagnostics according to NE 107 and VDI/VDE 2650. In addition to the status messages in the following tables there are more detailed error messages available under the menu item "Diagnostics" via the respective adjustment module.

## Status messages

The status messages are divided into the following categories:

- Failure
- Function check
- Out of specification
- Maintenance requirement

and explained by pictographs:

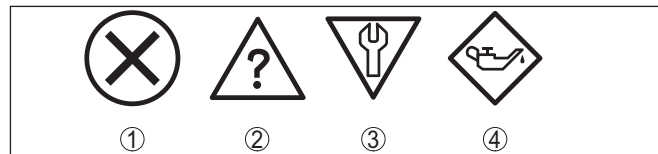

Fig. 29: Pictographs of the status messages

- 1 Failure - red
- 2 Out of specification - yellow
- 3 Function check - orange
- 4 Maintenance - blue

**Failure:** Due to a malfunction in the instrument, a fault message is output.

This status message is always active. It cannot be deactivated by the user.

**Function check:** The instrument is being worked on, the measured value is temporarily invalid (for example during simulation).

This status message is inactive by default.



**Out of specification:** The measured value is unreliable because an instrument specification was exceeded (e.g. electronics temperature).

This status message is inactive by default.

**Maintenance:** Due to external influences, the instrument function is limited. The measurement is affected, but the measured value is still valid. Plan in maintenance for the instrument because a failure is expected in the near future (e.g. due to buildup).

This status message is inactive by default.

**Failure**

Code Text message	Cause	Rectification	DevSpec State in CMD 48
F013 no measured value available	Sensor does not detect an echo during operation Process component or probe contaminated or defective	Check for correct mounting and/or parameter settings Clean or exchange process component or probe	Bit 0 of Byte 0 ... 5
F017 Adjustment span too small	Adjustment not within specification	Change adjustment according to the limit values (difference between min. and max. $\geq 10$ mm)	Bit 1 of Byte 0 ... 5
F025 Error in the linearization table	Index markers are not continuously rising, for example illogical value pairs	Check values of the linearization table Delete/create a new linearization table	Bit 2 of Byte 0 ... 5
F036 No operable software	Failed or interrupted software update	Repeat software update Check electronics version Exchanging the electronics Send instrument for repair	Bit 3 of Byte 0 ... 5
F040 Error in the electronics	Hardware defect	Exchanging the electronics Send instrument for repair	Bit 4 of Byte 0 ... 5
F041 Probe loss	Probe mechanically defective	Check probe and exchange, if necessary	Bit 13 of Byte 0 ... 5
F080 General software error	General software error	Disconnect operating voltage briefly	Bit 5 of Byte 0 ... 5
F105 Measured value is determined	The instrument is still in the start phase, the measured value could not yet be determined	Wait for the end of the switch-on phase Duration depending on the version and parameter adjustment max. 5 min.	Bit 6 of Byte 0 ... 5
F113 Communication error	EMC interference Transmission error during external communication with 4-wire power supply unit	Remove EMC influences Exchange 4-wire power supply unit or electronics	Bit 12 of Byte 0 ... 5

Code Text message	Cause	Rectification	DevSpec State in CMD 48
F260 Error in the calibration	Error in the calibration carried out in the factory Error in the EEPROM	Exchanging the electronics Send instrument for repair	Bit 8 of Byte 0 ... 5
F261 Error in the instrument settings	Error during setup Error when carrying out a reset False signal suppression faulty	Carry out a reset Repeat setup	Bit 9 of Byte 0 ... 5
F264 Installation/ Setup error	Error during setup	Check for correct mounting and/or parameter settings Check probe length	Bit 10 of Byte 0 ... 5
F265 Measurement function disturbed	Sensor no longer carries out a measurement	Carry out a reset Disconnect operating voltage briefly	Bit 11 of Byte 0 ... 5
F267 No executable sensor software	Sensor cannot start	Exchanging the electronics Send instrument for repair	No communication possible

Tab. 7: Error codes and text messages, information on causes as well as corrective measures (some specifications are only valid for four-wire instruments)

### Function check

Code Text message	Cause	Rectification	DevSpec State in CMD 48
C700 Simulation active	A simulation is active	Finish simulation Wait for the automatic end after 60 mins.	"Simulation Active" in "Standardized Status 0"

Tab. 8: Error codes and text messages, information on causes as well as corrective measures

### Out of specification

Code Text message	Cause	Rectification	DevSpec State in CMD 48
S600 Impermissible electronics temperature	Temperature of the processing electronics in the non-specified section	Check ambient temperature Insulate electronics Use instrument with higher temperature range	Bit 8 of Byte 14 ... 24
S601 Overfilling	Level echo in the close range not available	Reduce level 100 % adjustment: Increase value Check mounting socket Remove possible interfering signals in the close range Use coaxial probe	Bit 9 of Byte 14 ... 24

<b>Code Text message</b>	<b>Cause</b>	<b>Rectification</b>	<b>DevSpec State in CMD 48</b>
S602 Level within the search range, compensation echo	Compensation echo superimposed by medium	100 % adjustment: Increase value	Bit 10 of Byte 14 ... 24
S603 Impermissible operating voltage	Operating voltage below specified range	Check electrical connection If necessary, increase operating voltage	Bit 11 of Byte 14 ... 24

Tab. 9: Error codes and text messages, information on causes as well as corrective measures

**Maintenance**

<b>Code Text message</b>	<b>Cause</b>	<b>Rectification</b>	<b>DevSpec State in CMD 48</b>
M500 Error in the delivery status	The data could not be restored during the reset to delivery status	Repeat reset Load XML file with sensor data into the sensor	Bit 0 of Byte 14 ... 24
M501 Error in the non-active linearisation table	Index markers are not continuously rising, for example illogical value pairs	Check linearisation table Delete table/Create new	Bit 1 of Byte 14 ... 24
M504 Error at a device interface	Hardware defect	Exchanging the electronics Send instrument for repair	Bit 4 of Byte 14 ... 24
M505 no measured value available	Sensor does not detect an echo during operation	Check and correct mounting and/or parameter adjustment	Bit 5 of Byte 14 ... 24
	Process component or probe contaminated or defective	Clean or exchange process component or probe	
M506 Installation/Set-up error	Error during setup	Check and correct mounting and/or parameter adjustment Check probe length	Bit 6 of Byte 14 ... 24
M507 Error in the instrument settings	Error during setup Error when carrying out a reset False signal suppression faulty	Carry out reset and repeat setup	Bit 7 of Byte 14 ... 24

Tab. 10: Error codes and text messages, information on causes as well as corrective measures

**9.4 Rectify faults**

**Reaction when malfunction occurs**

The operator of the system is responsible for taking suitable measures to rectify faults.

**Fault rectification**

The first measures are:

- Evaluation of fault messages
- Checking the output signal
- Treatment of measurement errors

A smartphone/tablet with the adjustment app or a PC/notebook with the software PACTware and the suitable DTM offer you further comprehensive diagnostic possibilities. In many cases, the causes can be determined in this way and the faults eliminated.

#### 4 ... 20 mA signal

Connect a multimeter in the suitable measuring range according to the wiring plan. The following table describes possible errors in the current signal and helps to eliminate them:

Error	Cause	Rectification
4 ... 20 mA signal not stable	Fluctuating measured value	Set damping
4 ... 20 mA signal missing	Electrical connection faulty	Check connection, correct, if necessary
	Voltage supply missing	Check cables for breaks; repair if necessary
	Operating voltage too low, load resistance too high	Check, adapt if necessary
Current signal greater than 22 mA, less than 3.6 mA	Sensor electronics defective	Replace device or send in for repair depending on device version

#### Treatment of measurement errors

The below tables show typical examples for application-relevant measurement errors. There are two measurement errors:

- Constant level
- Filling
- Emptying

The images in column "Error pattern" show the real level as a broken line and the level displayed by the sensor as a continuous line.

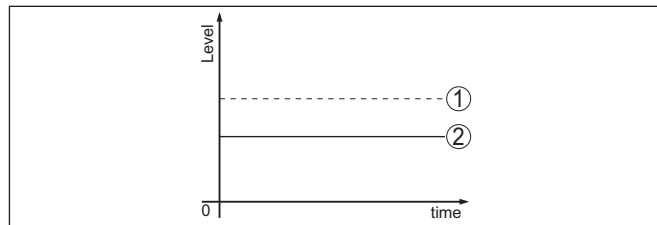

Fig. 30: The broken line 1 shows the real level, the continuous line 2 shows the level displayed by the sensor



#### Note:

If the output level is constant, the cause could also be the fault setting of the current output to "Hold value".

If the level is too low, the reason could be a line resistance that is too high

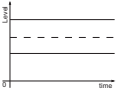
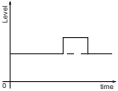

**Measurement error with constant level**

Fault description	Cause	Rectification
Measured value shows a too low or too high level 	Min./max. adjustment not correct	Adapt min./max. adjustment
	Incorrect linearisation curve	Adapt linearisation curve
	Running time error (small measurement error close to 100 %/serious error close to 0 %)	Repeat setup
Measured value jumps towards 100 % 	Due to the process, the amplitude of the product echo decreases A false signal suppression was not carried out	Carry out a false signal suppression
	Amplitude or position of a false signal has changed (e.g. buildup); false signal suppression no longer matches	Determine the reason for the changed false signals, carry out false signal suppression, e.g. with buildup

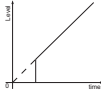
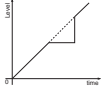
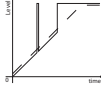
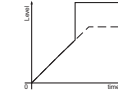
**Measurement error during filling**

Fault description	Cause	Rectification
Measured value remains in the area of the bottom during filling 	Echo from the probe end larger than the product echo, for example, with products with $\epsilon_r < 2.5$ oil-based, solvents, etc.	Check parameter "Medium" and "Vessel height", adapt if necessary
Measured value remains momentarily unchanged during filling and then jumps to the correct level 	Turbulence on the product surface, quick filling	Check parameters, change if necessary, e.g. in dosing vessel, reactor
Measured value jumps sporadically to 100 % during filling 	Changing condensation or contamination on the probe	Carry out a false signal suppression
Measured value jumps to $\geq 100\%$ or 0 m distance 	Level echo is no longer detected in the close range due to false signals in the close range. The sensor goes into overfill protection mode. The max. level (0 m distance) as well as the status message "Overfill protection" are output.	Eliminate false signals in the close range Check installation conditions If possible, switch off the function "Overfill protection"

### Measurement error during emptying

Fault description	Cause	Rectification
Measured value remains unchanged in the close range during emptying 	False signal larger than the level echo Level echo too small	Eliminate false signals in the close range Remove contamination on the probe. After having removed the source of the false signals, the false signal suppression must be deleted. Carry out a new false signal suppression
Measured value remains reproducible in one position during emptying 	Stored false signals in this position are larger than the level echo	Delete false signal suppression Carry out a new false signal suppression

#### Reaction after fault rectification

Depending on the reason for the fault and the measures taken, the steps described in chapter "Setup" must be carried out again or must be checked for plausibility and completeness.

#### 24 hour service hotline

Should these measures not be successful, please call in urgent cases the VEGA service hotline under the phone no. **+49 1805 858550**.

The hotline is also available outside normal working hours, seven days a week around the clock.

Since we offer this service worldwide, the support is provided in English. The service itself is free of charge, the only costs involved are the normal call charges.

### 9.5 Exchanging the electronics module

If the electronics module is defective, it can be replaced by the user.



In Ex applications, only instruments and electronics modules with appropriate Ex approval may be used.

If there is no electronics module available on site, the electronics module can be ordered through the agency serving you. The electronics modules are adapted to the respective sensor and differ in signal output or voltage supply.

The new electronics module must be loaded with the default settings of the sensor. These are the options:

- In the factory
- Or on site by the user

In both cases, the serial number of the sensor is needed. The serial numbers are stated on the type label of the instrument, on the inside of the housing as well as on the delivery note.

When loading on site, the order data must first be downloaded from the Internet (see operating instructions "*Electronics module*").

**Caution:**

All application-specific settings must be entered again. That's why you have to carry out a fresh setup after exchanging the electronics.

If you saved the parameter settings during the first setup of the sensor, you can transfer them to the replacement electronics module. A fresh setup is then not necessary.

## 9.6 Software update

The device software can be updated in the following ways:

- Interface adapter VEGACONNECT
- HART signal
- Bluetooth

Depending on the method, the following components are required:

- Instrument
- Voltage supply
- Interface adapter VEGACONNECT
- Display and adjustment module PLICSCOM with Bluetooth function
- PC with PACTware/DTM and Bluetooth USB adapter
- Current instrument software as file

You can find the current instrument software as well as detailed information on the procedure in the download area of our homepage: [www.vega.com](http://www.vega.com).

**Caution:**

Instruments with approvals can be bound to certain software versions. Therefore make sure that the approval is still effective after a software update is carried out.

You can find detailed information in the download area at [www.vega.com](http://www.vega.com).

## 9.7 How to proceed if a repair is necessary

You can find an instrument return form as well as detailed information about the procedure in the download area of our homepage. By doing this you help us carry out the repair quickly and without having to call back for needed information.

In case of repair, proceed as follows:

- Print and fill out one form per instrument
- Clean the instrument and pack it damage-proof
- Attach the completed form and, if need be, also a safety data sheet outside on the packaging
- Ask the agency serving you to get the address for the return shipment. You can find the agency on our homepage.

## 10 Dismount

### 10.1 Dismounting steps

**Warning:**

Before dismantling, be aware of dangerous process conditions such as e.g. pressure in the vessel or pipeline, high temperatures, corrosive or toxic media etc.

Take note of chapters "*Mounting*" and "*Connecting to voltage supply*" and carry out the listed steps in reverse order.

### 10.2 Disposal

The instrument consists of materials which can be recycled by specialised recycling companies. We use recyclable materials and have designed the electronics to be easily separable.

**WEEE directive**

The instrument does not fall in the scope of the EU WEEE directive. Article 2 of this Directive exempts electrical and electronic equipment from this requirement if it is part of another instrument that does not fall in the scope of the Directive. These include stationary industrial plants.

Pass the instrument directly on to a specialised recycling company and do not use the municipal collecting points.

If you have no way to dispose of the old instrument properly, please contact us concerning return and disposal.



# 11 Supplement

## 11.1 Technical data

### General data

316L corresponds to 1.4404 or 1.4435

#### Materials, wetted parts

- Process fitting PTFE-TFM 1600
- Process seal PTFE-TFM 1600
- Rod:  $\varnothing$  10 mm (0.394 in) 316L, PFA coated
- Cable:  $\varnothing$  4 mm (0.157 in) 316 (1.4401), PFA coated
- Gravity weight PFA coated

#### Materials, non-wetted parts

- Plastic housing Plastic PBT (Polyester)
- Aluminium die-cast housing Aluminium die-casting AlSi10Mg, powder-coated (Basis: Polyester)
- Stainless steel housing (precision casting) 316L
- Stainless steel housing (electropolished) 316L
- Seal between housing and housing lid Silicone SI 850 R
- Inspection window in housing cover (optional) Plastic housing: Polycarbonate  
Metal housing: Glass
- Ground terminal 316L
- Cable gland PA, stainless steel, brass
- Sealing, cable gland NBR
- Blind plug, cable gland PA

#### Process fittings

- Clamp from 2"
- Slotted nut from DN 32 PN 40
- Flanges DIN from DN 25, ASME from 2"

#### Weight

- Instrument weight (depending on process fitting) approx. 0.8 ... 8 kg (0.176 ... 17.64 lbs)
- Rod:  $\varnothing$  10 mm (0.394 in), PFA coated approx. 330 g/m (3.55 oz/ft)
- Cable:  $\varnothing$  4 mm (0.157 in), PFA coated approx. 41 g/m (0.44 oz/ft)
- Gravity weight (long) for cable  $\varnothing$  4 mm (0.157 in) 325 g (11.5 oz)

#### Probe length L (from seal surface)

- Rod:  $\varnothing$  10 mm (0.394 in), PFA coated up to 4 m (13.12 ft)
- Trimming accuracy (rod)  $\pm(1 \text{ mm} + 0.05 \% \text{ of the rod length})$
- Cable:  $\varnothing$  4 mm (0.157 in), PFA coated up to 32 m (105 ft)
- Trimming accuracy (cable)  $\pm(2 \text{ mm} + 0.05 \% \text{ of the cable length})$

Lateral load with rod:  $\varnothing$  10 mm (0.394 in), 4 Nm (3 lbf ft)  
PFA coated

Max. tensile load with cable:  $\varnothing$  4 mm 2 KN (450 lbf)  
(0.157 in), PFA coated

Torque for NPT cable glands and Conduit tubes

- Plastic housing max. 10 Nm (7.376 lbf ft)
- Aluminium/Stainless steel housing max. 50 Nm (36.88 lbf ft)

---

### Input variable

---

Measured variable Level of liquids

Min. dielectric constant of the medium

- Cable probes  $\epsilon_r \geq 1.6$
- Rod probes  $\epsilon_r \geq 1.6$

---

### Output variable

---

Output signal 4 ... 20 mA/HART

Range of the output signal 3.8 ... 20.5 mA/HART (default setting)

Fulfilled HART specification 7

Signal resolution 0.3  $\mu$ A

Fault signal, current output (adjustable) Last valid measured value,  $\geq 21.0$  mA,  $\leq 3.6$  mA

In order to detect the rarely occurring hardware failures in the device, we recommend monitoring both interference values ( $\geq 21.0$  mA,  $\leq 3.6$  mA)

Max. output current 21.5 mA

Starting current

- for 5 ms after switching on  $\leq 10$  mA
- for run-up time  $\leq 3.6$  mA

Load see load under Power supply

Damping (63 % of the input variable), adjustable 0 ... 999 s

HART output values according to HART 7 (default setting)<sup>1)</sup>

- First HART value (PV) Linearised percentage value, level
- Second HART value (SV) Distance to the level
- Third HART value (TV) Measurement reliability, level
- Fourth HART value (QV) Electronics temperature

Indication value - Display and adjustment module<sup>2)</sup>

- Displayed value 1 Filling height Level
- Displayed value 2 Electronics temperature

Resolution, digital < 1 mm (0.039 in)

<sup>1)</sup> The output values can be assigned individually.

<sup>2)</sup> The indication values can be assigned individually.

**Output variable - Additional current output**

For details on the operating voltage see chapter "Voltage supply"

Output signal	4 ... 20 mA (passive)
Range of the output signal	3.8 ... 20.5 mA (default setting)
Signal resolution	0.3 µA
Fault signal, current output (adjustable)	Last valid measured value, $\geq 21.0$ mA, $\leq 3.6$ mA In order to detect the rarely occurring hardware failures in the device, we recommend monitoring both interference values ( $\geq 21.0$ mA, $\leq 3.6$ mA)
Max. output current	21.5 mA
Starting current	
– for 20 ms after switching on	$\leq 10$ mA
– for run-up time	$\leq 3.6$ mA
Load	Load resistor, see chapter "Voltage supply"
Damping (63 % of the input variable), adjustable	0 ... 999 s
Indication value - Display and adjustment module <sup>3)</sup>	
– Displayed value 1	Filling height Level
– Displayed value 2	Electronics temperature
Resolution, digital	< 1 mm (0.039 in)

**Measurement accuracy (according to DIN EN 60770-1)**

Process reference conditions according to DIN EN 61298-1

– Temperature	+18 ... +30 °C (+64 ... +86 °F)
– Relative humidity	45 ... 75 %
– Air pressure	+860 ... +1060 mbar/+86 ... +106 kPa (+12.5 ... +15.4 psig)

Mounting, reference conditions

– Min. distance to internal installations	> 500 mm (19.69 in)
– Vessel	metallic, $\varnothing$ 1 m (3.281 ft), centric mounting, process fitting flush with the vessel ceiling
– Medium	Water/Oil (dielectric constant $\sim 2.0$ ) <sup>4)</sup>
– Mounting	Probe end does not touch the vessel bottom

Sensor parameter adjustment No gating out of false signals carried out

Typical deviation - Interface measurement  $\pm 5$  mm (0.197 in)

<sup>3)</sup> The indication values can be assigned individually.

<sup>4)</sup> With interface measurement = 2.0

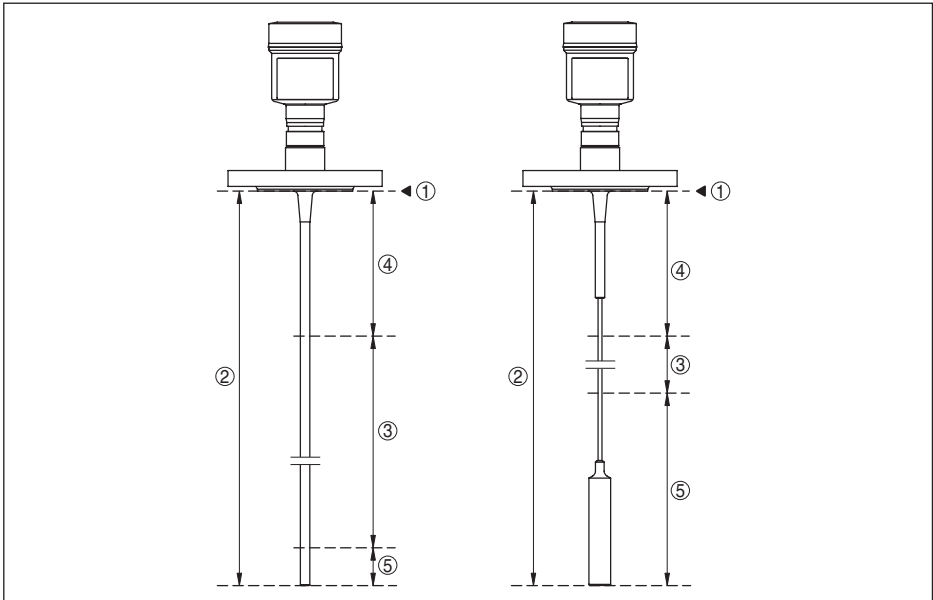

Fig. 31: Measuring ranges - VEGAFLEX 83

- 1 Reference plane
- 2 Probe length  $L$
- 3 Measuring range (default setting refers to the measuring range in water)
- 4 Upper dead zone (see following diagrams - grey section)
- 5 Lower dead zone (see following diagrams - grey section)

Typical deviation - Total level interface      See following diagrams  
measurement

Typical deviation - Level measurement<sup>5)6)</sup>      See following diagrams

<sup>5)</sup> Depending on the mounting conditions, deviations can occur which can be rectified by adapting the adjustment or changing the measured value offset in the DTM service mode.

<sup>6)</sup> The dead zones can be optimized via a false signal suppression.

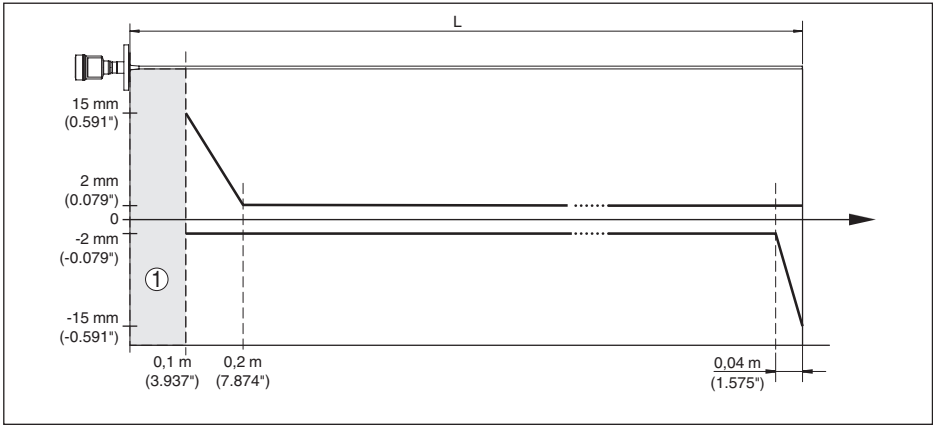

Fig. 32: Deviation VEGAFLEX 83 in rod version (coated) in water

- 1 Dead zone (no measurement possible in this area)
- L Probe length

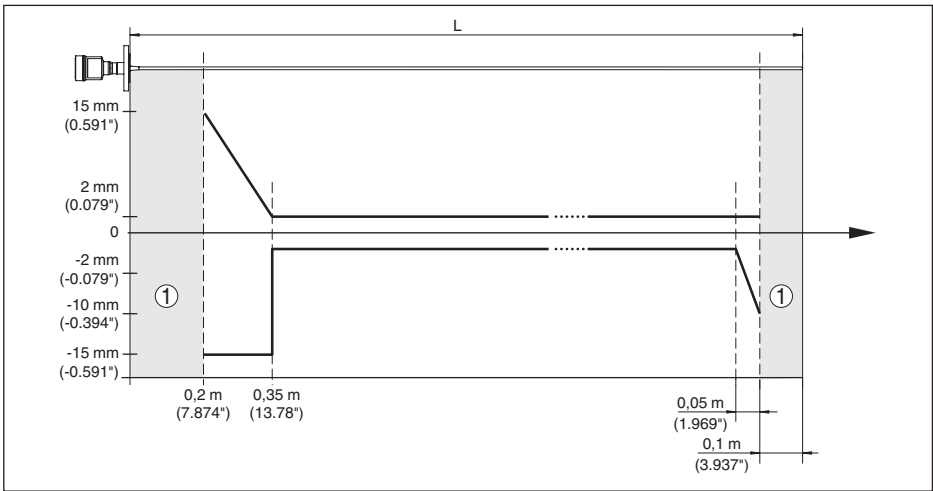

Fig. 33: Deviation VEGAFLEX 83 in rod version (coated) in oil

- 1 Dead zone (no measurement possible in this area)
- L Probe length

Deviation (cable) from 6 m probe length = 0.5 % of the probe length

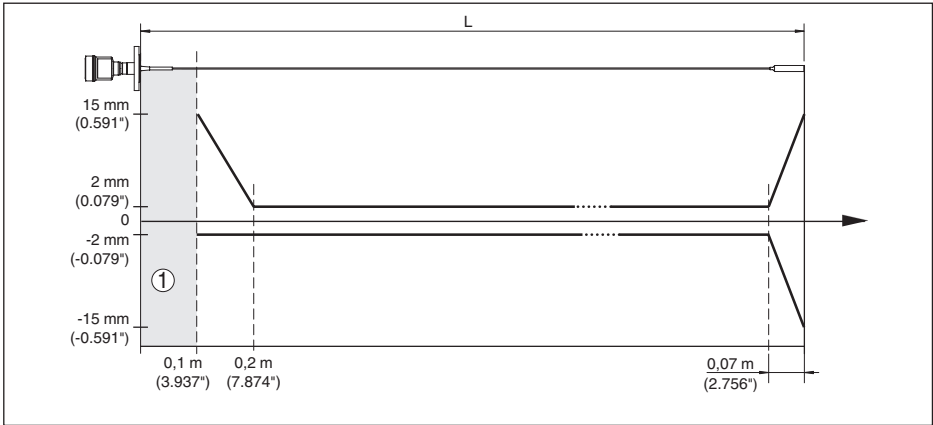

Fig. 34: Deviation VEGAFLEX 83 in cable version (coated) in water

- 1 Dead zone (no measurement possible in this area)
- L Probe length

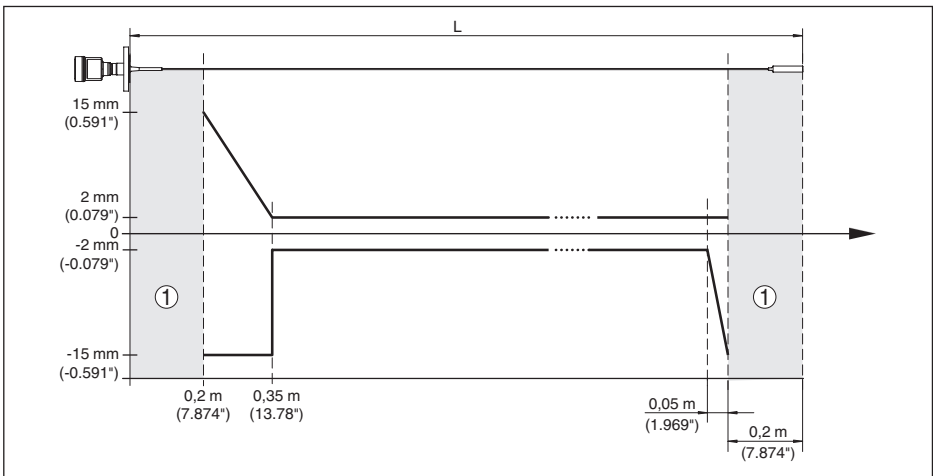

Fig. 35: Deviation VEGAFLEX 83 in cable version (coated) in oil

- 1 Dead zone (no measurement possible in this area)
- L Probe length

Non-repeatability  $\leq \pm 1$  mm

**Variables influencing measurement accuracy**

**Specifications for the digital measured value**

Temperature drift - Digital output  $\pm 3$  mm/10 K relating to the max. measuring range or max. 10 mm (0.394 in)

Additional deviation through electromagnetic interference acc. to EN 61326  $< \pm 10$  mm ( $< \pm 0.394$  in)

**Specifications apply also to the current output<sup>7)</sup>**

Temperature drift - Current output             $\pm 0.03\% / 10\text{ K}$  relating to the 16 mA span or max.  $\pm 0.3\%$

Deviation in the current output due to digital/analogue conversion

- Non-Ex and Ex-ia version                     $< \pm 15\ \mu\text{A}$
- Ex-d-ia version                                  $< \pm 40\ \mu\text{A}$

Additional deviation through electromag-  $< \pm 150\ \mu\text{A}$   
netic interference acc. to EN 61326

**Influence of the superimposed gas and pressure on measurement accuracy**

The propagation speed of the radar impulses in gas or vapour above the medium is reduced by high pressure. This effect depends on the superimposed gas or vapours.

The following table shows the resulting deviation for some typical gases and vapours. The specified values refer to the distance. Positive values mean that the measured distance is too large, negative values that the measured distance is too small.

Gas phase	Temperature	Pressure		
		1 bar (14.5 psig)	10 bar (145 psig)	50 bar (725 psig)
Air	20 °C (68 °F)	0 %	0.22 %	1.2 %
	200 °C (392 °F)	-0.01 %	0.13 %	0.74 %
	400 °C (752 °F)	-0.02 %	0.08 %	0.52 %
Hydrogen	20 °C (68 °F)	-0.01 %	0.1 %	0.61 %
	200 °C (392 °F)	-0.02 %	0.05 %	0.37 %
	400 °C (752 °F)	-0.02 %	0.03 %	0.25 %
Steam (saturated steam)	100 °C (212 °F)	0.26 %	-	-
	180 °C (356 °F)	0.17 %	2.1 %	-
	264 °C (507 °F)	0.12 %	1.44 %	9.2 %
	366 °C (691 °F)	0.07 %	1.01 %	5.7 %

**Characteristics and performance data**

Measuring cycle time                             $< 500\text{ ms}$

Step response time<sup>8)</sup>                            $\leq 3\text{ s}$

Max. filling/emptying speed                  $1\text{ m/min}$

Products with high dielectric constant ( $>10$ ) up to  $5\text{ m/min}$ .

**Ambient conditions**

Ambient, storage and transport temperature

- Standard                                          $-40 \dots +80\text{ °C} (-40 \dots +176\text{ °F})$
- CSA, Ordinary Location                      $-40 \dots +60\text{ °C} (-40 \dots +140\text{ °F})$

<sup>7)</sup> Also for the additional current output (optional).

<sup>8)</sup> Time span after a sudden measuring distance change by max. 0.5 m in liquid applications, max 2 m with bulk solids applications, until the output signal has taken for the first time 90 % of the final value (IEC 61298-2).

## Process conditions

For the process conditions, please also note the specifications on the type label. The lowest value always applies.

The measurement error through the process conditions in the specified pressure and temperature range is < 1 %.

Process pressure

- Clamp, flange version  $\leq 2''/\text{DN } 50$  -0.5 ... +16 bar/-50 ... +1600 kPa (-7.3 ... +232 psig), depending on the process fitting
- Clamp, flange version  $> 2''/\text{DN } 50$  -0.2 ... +16 bar/-20 ... +1600 kPa (-2.9 ... +232 psig), depending on the process fitting

Vessel pressure relating to the flange nominal pressure stage

see supplementary instructions manual "*Flanges according to DIN-EN-ASME-JIS*"

Process temperature (Clamp or flange temperature)

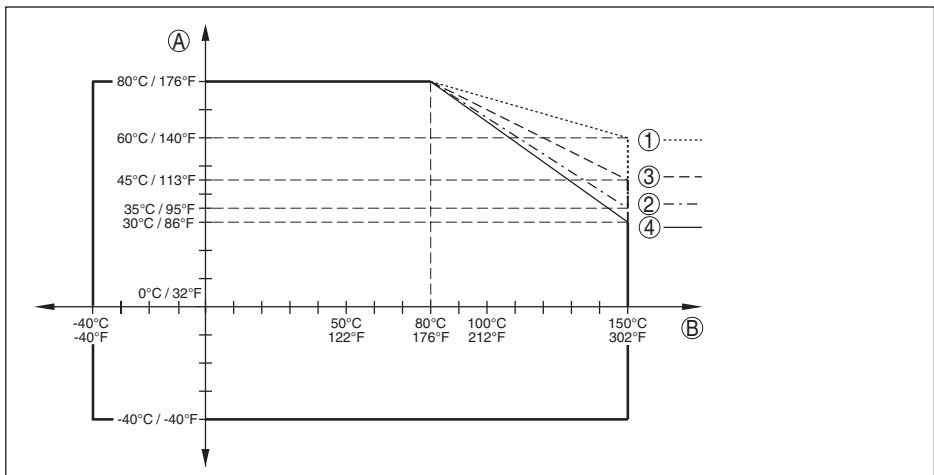

Fig. 36: Ambient temperature - process temperature, standard version

A Ambient temperature

B Process temperature (depending on the seal material)

1 Aluminium housing

2 Plastic housing

3 Stainless steel housing, precision casting

4 Stainless steel housing, electropolished

## Mechanical stress

Vibration resistance

- Rod probe 1 g with 5 ... 200 Hz according EN 60068-2-6 (vibration at resonance) with rod length 50 cm (19.69 in)

Shock resistance

- Rod probe 25 g, 6 ms according to EN 60068-2-27 (mechanical shock) with rod length 50 cm (19.69 in)



## Electromechanical data - version IP66/IP67 and IP66/IP68 (0.2 bar)

### Options of the cable entry

- Cable entry M20 x 1.5; ½ NPT
- Cable gland M20 x 1.5; ½ NPT (cable ø see below table)
- Blind plug M20 x 1.5; ½ NPT
- Closing cap ½ NPT

Material cable gland	Material seal insert	Cable diameter				
		4.5 ... 8.5 mm	5 ... 9 mm	6 ... 12 mm	7 ... 12 mm	10 ... 14 mm
PA	NBR	-	●	●	-	●
Brass, nickel-plated	NBR	●	●	●	-	-
Stainless steel	NBR	-	●	●	-	●

### Wire cross-section (spring-loaded terminals)

- Massive wire, stranded wire 0.2 ... 2.5 mm<sup>2</sup> (AWG 24 ... 14)
- Stranded wire with end sleeve 0.2 ... 1.5 mm<sup>2</sup> (AWG 24 ... 16)

## Electromechanical data - version IP66/IP68 (1 bar)

### Options of the cable entry

- Cable gland with integrated connection cable M20 x 1.5 (cable diameter 5 ... 9 mm)
- Cable entry ½ NPT
- Blind plug M20 x 1.5; ½ NPT

### Connection cable

- Configuration four wires, one suspension cable, braiding, metal foil, cover
- Wire cross-section 0.5 mm<sup>2</sup> (AWG 20)
- Wire resistance < 0.036 Ω/m
- Tensile strength < 1200 N (270 lbf)
- Standard length 5 m (16.4 ft)
- Max. length 180 m (590.6 ft)
- Min. bending radius (at 25 °C/77 °F) 25 mm (0.984 in)
- Diameter approx. 8 mm (0.315 in)
- Colour - Non-Ex version Black
- Colour - Ex-version Blue

## Integrated clock

Date format	Day.Month.Year
Time format	12 h/24 h
Time zone, factory setting	CET
Max. rate deviation	10.5 min/year

---

**Additional output parameter - Electronics temperature**

---

Range	-40 ... +85 °C (-40 ... +185 °F)
Resolution	< 0.1 K
Deviation	±3 K
Output of the temperature values	
– Indication	Via the display and adjustment module
– Output	Via the respective output signal

---

**Voltage supply**

---

Operating voltage $U_B$	9.6 ... 35 V DC
Operating voltage $U_B$ with lighting switched on	16 ... 35 V DC
Reverse voltage protection	Integrated
Permissible residual ripple	
– for $9.6 \text{ V} < U_B < 14 \text{ V}$	$\leq 0.7 V_{\text{eff}}$ (16 ... 400 Hz)
– for $18 \text{ V} < U_B < 36 \text{ V}$	$\leq 1 V_{\text{eff}}$ (16 ... 400 Hz)
Load resistor	
– Calculation	$(U_B - U_{\text{min}})/0.022 \text{ A}$
– Example - with $U_B = 24 \text{ V DC}$	$(24 \text{ V} - 9.6 \text{ V})/0.022 \text{ A} = 655 \Omega$

---

**Potential connections and electrical separating measures in the instrument**

---

Electronics	Not non-floating
Reference voltage <sup>9)</sup>	500 V AC
Conductive connection	Between ground terminal and metallic process fitting

---

**Electrical protective measures**

---

Housing material	Version	Protection acc. to IEC 60529	Protection acc. to NEMA
Plastic	Single chamber	IP66/IP67	Type 4X
	Double chamber	IP66/IP67	Type 4X
Aluminium	Single chamber	IP66/IP68 (0.2 bar) IP66/IP68 (1 bar)	Type 6P -
	Double chamber	IP66/IP68 (0.2 bar) IP66/IP68 (1 bar)	Type 6P -
Stainless steel (electro-polished)	Single chamber	IP66/IP68 (0.2 bar)	Type 6P
Stainless steel (precision casting)	Single chamber	IP66/IP68 (0.2 bar) IP66/IP68 (1 bar)	Type 6P -
	Double chamber	IP66/IP68 (0.2 bar) IP66/IP68 (1 bar)	Type 6P -

<sup>9)</sup> Galvanic separation between electronics and metal housing parts

Connection of the feeding power supply unit Networks of overvoltage category III

Altitude above sea level

- by default up to 2000 m (6562 ft)
- with connected overvoltage protection up to 5000 m (16404 ft)

Pollution degree (with fulfilled housing protection) 4

Protection rating (IEC 61010-1) III

## 11.2 Dimensions

The following dimensional drawings represent only an extract of all possible versions. Detailed dimensional drawings can be downloaded at [www.vega.com/downloads](http://www.vega.com/downloads) under "Drawings".

### Plastic housing

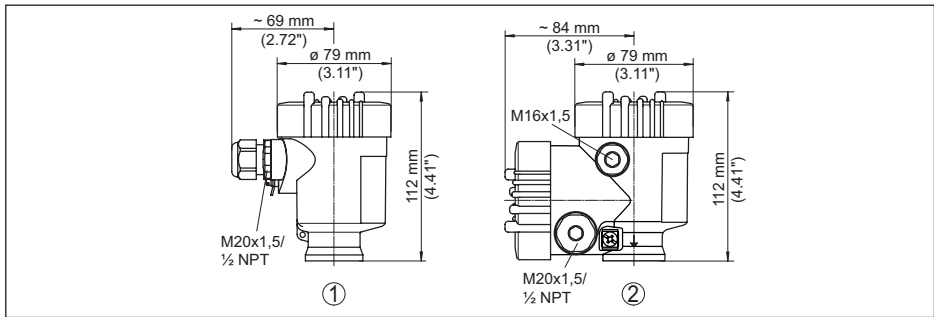

Fig. 37: Housing versions in protection IP66/IP67 (with integrated display and adjustment module the housing is 9 mm/0.35 in higher)

- 1 Plastic single chamber
- 2 Plastic double chamber

### Aluminium housing

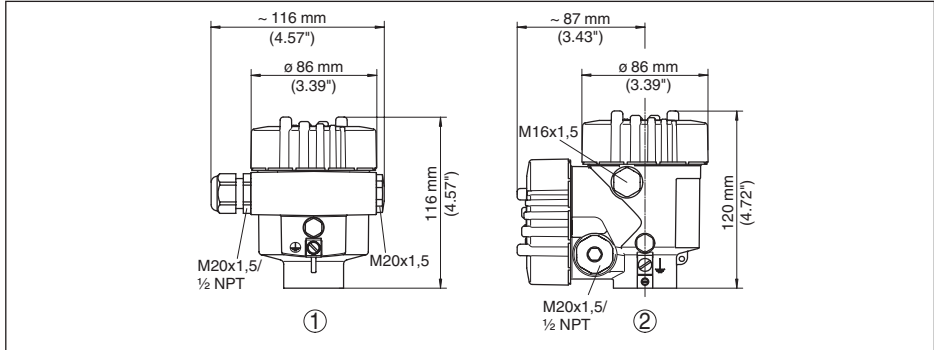

Fig. 38: Housing versions with protection rating IP66/IP68 (0.2 bar), (with integrated display and adjustment module the housing is 9 mm/0.35 in higher)

- 1 Aluminium - single chamber
- 2 Aluminium - double chamber

### Aluminium housing with protection rating IP66/IP68 (1 bar)

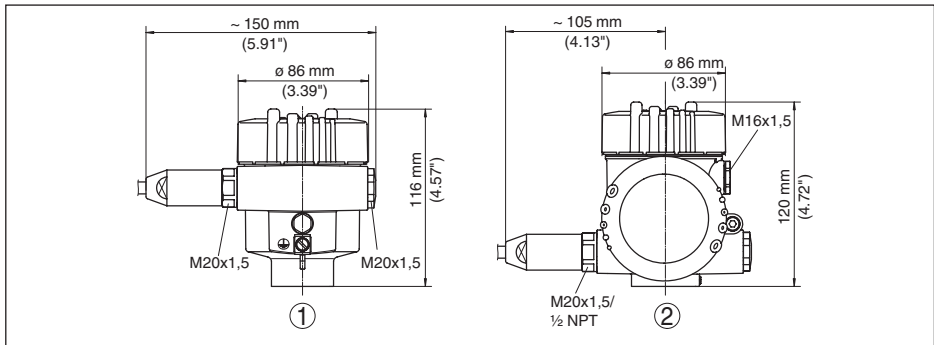

Fig. 39: Housing version with protection rating IP66/IP68 (1 bar), (with integrated display and adjustment module the housing is 9 mm/0.35 in higher)

- 1 Aluminium - single chamber
- 2 Aluminium - double chamber

**Stainless steel housing**

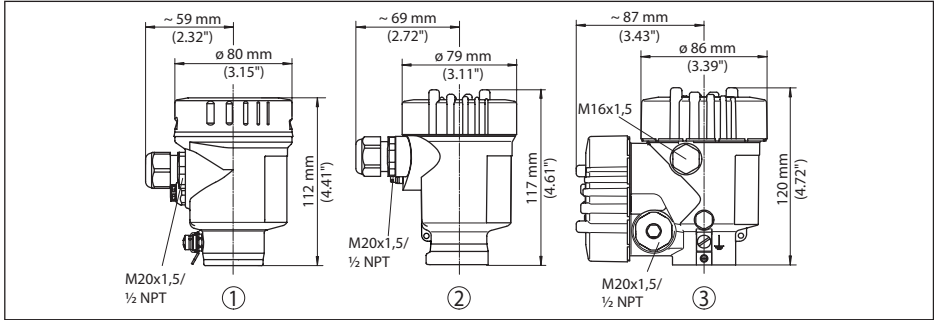

Fig. 40: Housing versions with protection rating IP66/IP68 (0.2 bar), (with integrated display and adjustment module the housing is 9 mm/0.35 in higher)

- 1 Stainless steel single chamber (electropolished)
- 2 Stainless steel single chamber (precision casting)
- 3 Stainless steel double chamber housing (precision casting)

**Stainless steel housing with protection rating IP66/IP68 (1 bar)**

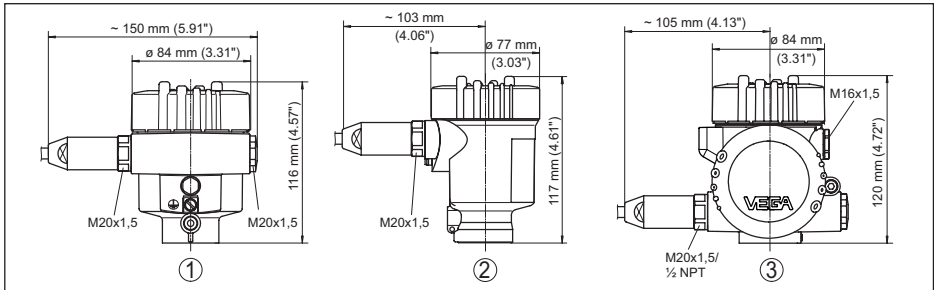

Fig. 41: Housing version with protection rating IP66/IP68 (1 bar), (with integrated display and adjustment module the housing is 9 mm/0.35 in higher)

- 1 Stainless steel single chamber (electropolished)
- 2 Stainless steel single chamber (precision casting)
- 3 Stainless steel double chamber housing (precision casting)

VEGAFLEX 83, cable version  $\varnothing$  4 mm (0.157 in), PFA coated

Fig. 42: VEGAFLEX 83, cable version with gravity weight

- $L$  Sensor length, see chapter "Technical data"
- 1 Cable version,  $\varnothing$  4 mm (0.157 in) with flange
- 2 Cable version with Clamp
- 3 Cable version with slotted nut

**VEGAFLEX 83, rod version  $\varnothing$  10 mm (0.394 in), PFA coated**

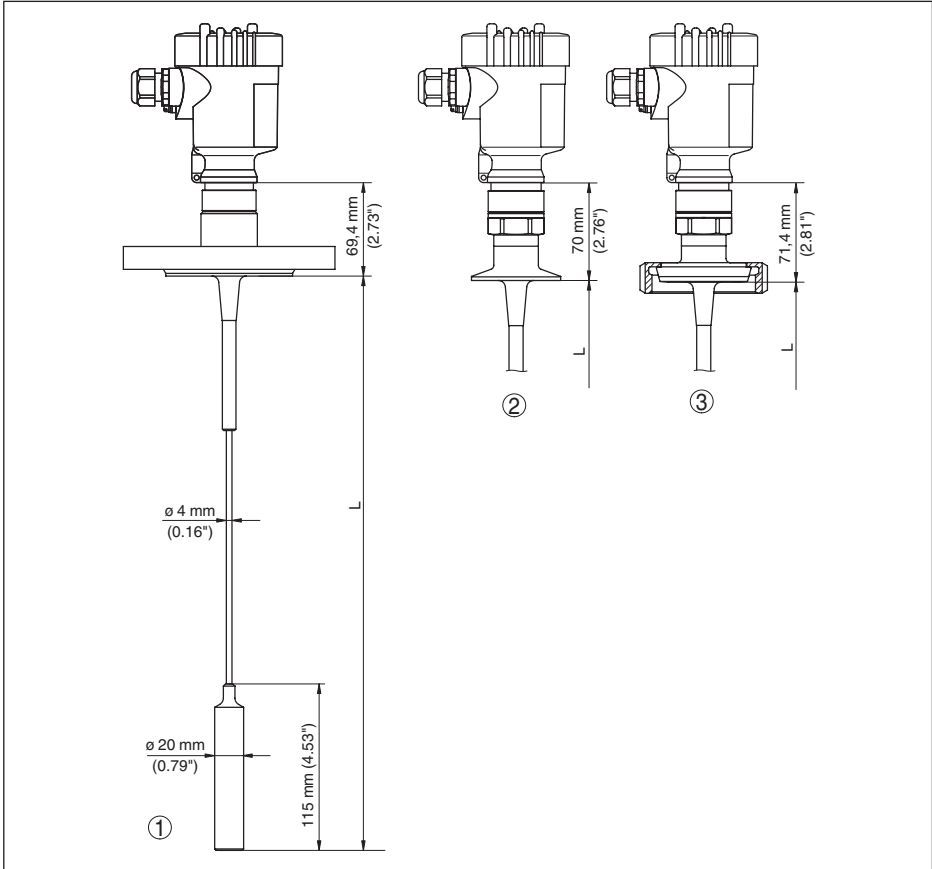
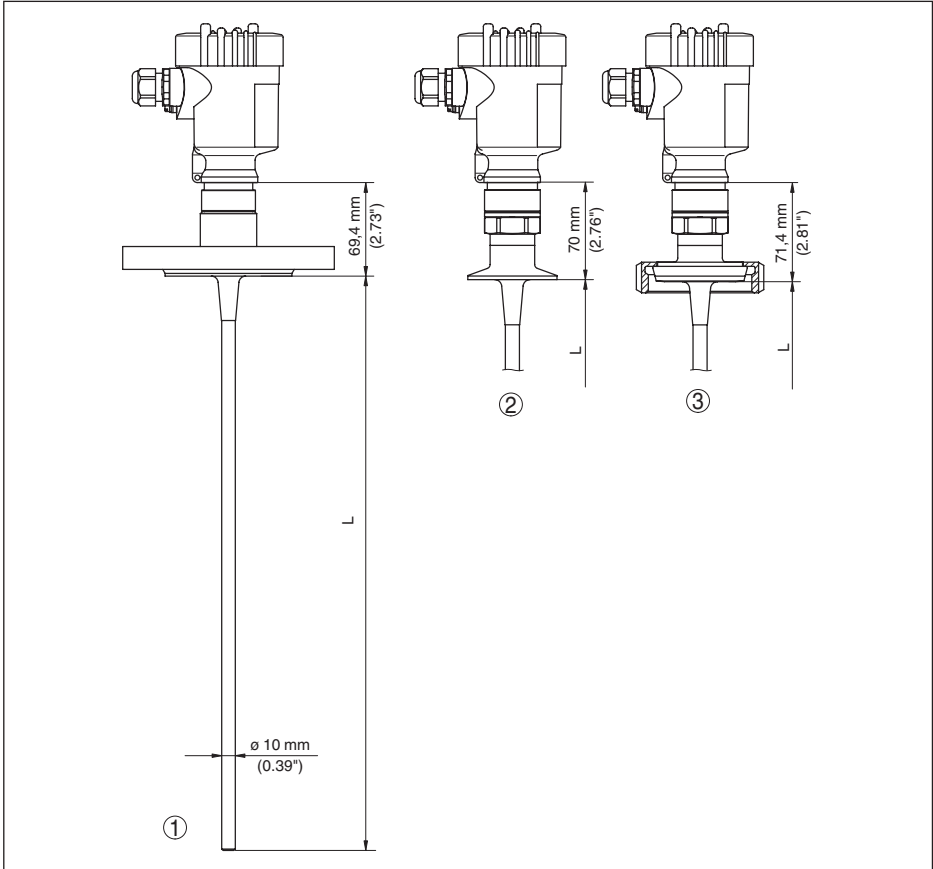

Fig. 43: VEGAFLEX 83, rod version

*L* Sensor length, see chapter "Technical data"

1 Rod version,  $\varnothing$  10 mm (0.394 in) with flange

2 Rod version with Clamp

3 Rod version with slotted nut

### 11.3 Industrial property rights

VEGA product lines are global protected by industrial property rights. Further information see [www.vega.com](http://www.vega.com).

VEGA Produktfamilien sind weltweit geschützt durch gewerbliche Schutzrechte.

Nähere Informationen unter [www.vega.com](http://www.vega.com).

Les lignes de produits VEGA sont globalement protégées par des droits de propriété intellectuelle. Pour plus d'informations, on pourra se référer au site [www.vega.com](http://www.vega.com).

VEGA líneas de productos están protegidas por los derechos en el campo de la propiedad industrial. Para mayor información revise la pagina web [www.vega.com](http://www.vega.com).

Линии продукции фирмы ВЕГА защищаются по всему миру правами на интеллектуальную собственность. Дальнейшую информацию смотрите на сайте [www.vega.com](http://www.vega.com).

VEGA系列产品在全球享有知识产权保护。

进一步信息请参见网站[www.vega.com](http://www.vega.com)。

### 11.4 Trademark

All the brands as well as trade and company names used are property of their lawful proprietor/originator.



**INDEX****A**

- Accessories
  - Display and adjustment module 12
  - External display and adjustment unit 13
- Adjustment
  - Max. adjustment 34
  - Min. adjustment 34, 35
- Adjustment system 30
- Application 32, 33
- Application area 10

**B**

- Backlight 39

**C**

- Check output signal 60
- Copy sensor settings 45
- Current output 47
- Current output 2 38
- Current output, adjustment 47
- Current output, meas. variable 47
- Current output, min./max. 37
- Current output mode 36
- Curve display
  - Echo curve 41

**D**

- Damping 35
- Date of manufacture 48
- Date/Time 42
- Default values 43
- Deviation 60
- Display format 39

**E**

- Echo curve memory 56
- Echo curve of the setup 42
- EDD (Enhanced Device Description) 54
- Electrical connection 20, 21
- Electronics and connection compartment 23
- Electronics compartment - double chamber housing 23
- Error codes 58
- Event memory 55

**F**

- Factory calibration date 48
- False signal suppression 37
- Fault
  - Rectification 59

- Fault rectification 59
- Functional principle 10

**G**

- Gas phase 33
- Grounding 21

**H**

- HART 50
- HART address 47

**I**

- Inflowing medium 17
- Installation position 15

**K**

- Key function 29

**L**

- Language 39
- Linearisation 35
- Lock adjustment 38

**M**

- Main menu 31
- Measured value indication 39
- Measured value memory 55
- Measurement loop name 32
- Measurement reliability 40

**N**

- NAMUR NE 107 56
  - Failure 57
  - Maintenance 59
  - Out of specification 58

**P**

- Peak value indicator 40, 41
- Probe length 32
- Probe type 47

**Q**

- Quick setup 30

**R**

- Read out info 48
- Repair 63
- Replacement parts
  - Display and adjustment module with heating 13
  - Spacer 13

Reset 43

## **S**

Scaling measured value 46, 47

Sensor characteristics 48

Sensor status 40

Service hotline 62

Simulation 41

Special parameters 48

## **T**

Type label 8

Type of medium 32

## **U**

Units 32



Printing date:

**VEGA**

All statements concerning scope of delivery, application, practical use and operating conditions of the sensors and processing systems correspond to the information available at the time of printing.

Subject to change without prior notice

© VEGA Grieshaber KG, Schiltach/Germany 2020



41834-EN-200212

VEGA Grieshaber KG  
Am Hohenstein 113  
77761 Schiltach  
Germany

Phone +49 7836 50-0  
Fax +49 7836 50-201  
E-mail: [info.de@vega.com](mailto:info.de@vega.com)  
[www.vega.com](http://www.vega.com)