

Installation and setting instructions vent-captor 3202.0x (3205.0x)



Please read carefully: No liability for damages caused by improper handling of the vent-captor.

The following instructions refer to units with normally open output!

5.2 With zero flow turn the potentiometer to the left until the LED lights **“green”** (output switched through). Then turn potentiometer clockwise until LED lights up **“red”** (most sensitive setting). Turn on the potentiometer a maximum of 18 times = lowest sensitivity.

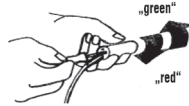

Note: Potentiometer for max. 18 revolutions without mechanical end stop

6. Monitoring the lower flow switch-point

- 6.1 Adjust air flow rate to desired signal output
- 6.2 After 5 minutes turn the potentiometer slowly clockwise until LED lights **“red”**
- 6.3 Restore normal flow and wait 3 minutes. When the LED shines **“green”**, the adjustment is OK.
- 6.4 If the LED remains **“red”** the speed difference is too low. In this case repeat steps 6.1 to 6.4

7. Monitoring the upper flow switch-point

- 7.1 Adjust air flow rate to desired signal output
- 7.2 Turn potentiometer clockwise until LED lights **“red”**.
- 7.3 After 5 minutes turn potentiometer slowly to the left until LED lights **“green”**.
- 7.4 Restore normal flow and wait 3 minutes. When the LED shines **“red”**, the adjustment is OK.
- 7.5 If the LED remains **“green”** the speed difference is too low. In this case repeat steps 7.1 to 7.5



Installation and setting instructions vent-captor 3202.0x (3205.0x)



Please read carefully: No liability for damages caused by improper handling of the vent-captor.



Type 3202.0x with flange

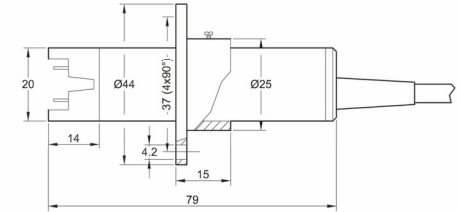

With flange (atmospheric pressure)

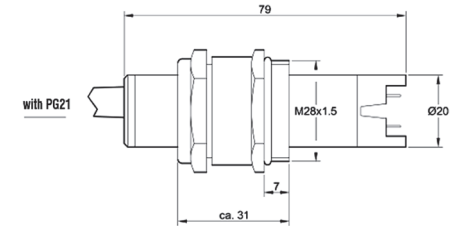

with PG21 (up to max. 1 bar)

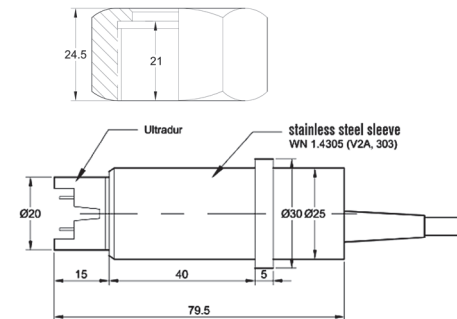

with union nut in stainless steel casing (from 1 bar to max. 10 bar) 3205.0x

Type 3205.0x: Techn. Data as 3202.0x
max. pressure 10 bar, installation with union nut
G 1" A, SW 37 mm, DIN 259, ISO 228
mass approx. 200 g without nut

weber

weber

Installation and setting instructions vent-captor 3202.0x (3205.0x)



Please read carefully: No liability for damages caused by improper handling of the vent-captor.

1. Assembly

The installation is carried out by means of the enclosed flange or PG21 for type 3202.0x or with a union nut to fix the metal version type 3205.0x

1.1 Installation depth

Depending on the pipe cross section but at least 15 mm. Metal PG21 fittings are modified by the manufacturer. Modification is indicated by 1" on the union nut.

1.2 Mounting orientation

Position the captor in such a way that the sensors are longitudinal parallel to the flow.



2. Electrical connection

Make sure that the vent-captors are connected to power as shown in the connection diagrams below.

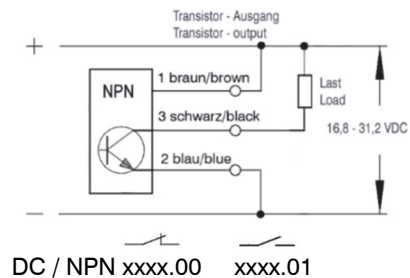

3202.0x /
3205.0x

DC / NPN xxxx.00 xxxx.01

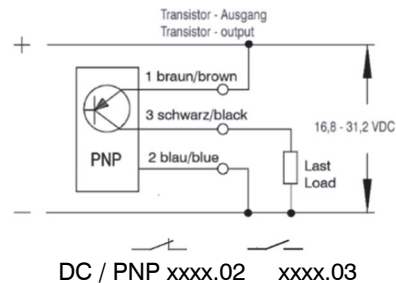

DC / PNP xxxx.02 xxxx.03

weber

Installation and setting instructions vent-captor 3202.0x (3205.0x)



Please read carefully: No liability for damages caused by improper handling of the vent-captor.

3. Switching characteristic

3.1 Switching delay

The switching delay of the vent-captor is defined as the time between exceeding or falling below the adjusted set-point and the switching of the sensor. The switching delay is not constant. So the shorter the delay the greater the deviation of the actual flow speed from the adjusted switching point. The delay is between 2 seconds and more than 30 seconds.

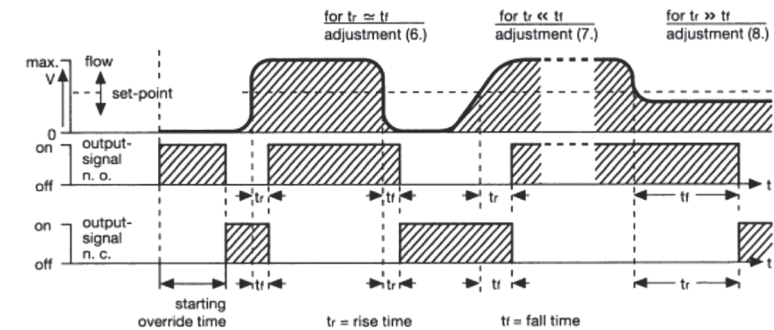

4. LED-function

Sensors with NO contact function: types .01 / .03

LED "red" – no flow = switching state OFF

LED "green" – flow = switching state ON

Sensors with NC contact function: types .00 / .02

LED "green" – no flow = switching state ON

LED "red" – flow = switching state OFF

5. Switch point adjustment

For general applications, vent-captors are set at the factory to a switching flow rate of less than 4 m/s and are therefore directly ready for operation without further adjustment.

5.1 Change of switching point

Only 5 minutes after switching ON the operating voltage a stable function of sensor is achieved.

5.1.1 Lower sensitivity = higher switching point

5.1.2 Higher sensitivity = lower switching point

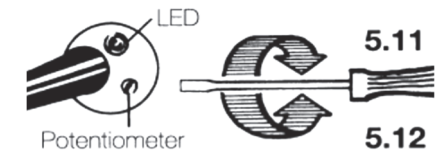

weber