

Operating Instructions

Controller and display instrument for
level sensors

VEGAMET 391

4 ... 20 mA/HART



Document ID: 36032



VEGA

Contents

1	About this document	4
1.1	Function	4
1.2	Target group	4
1.3	Symbols used.....	4
2	For your safety	5
2.1	Authorised personnel	5
2.2	Appropriate use.....	5
2.3	Warning about incorrect use.....	5
2.4	General safety instructions	5
2.5	Installation and operation in the USA and Canada	6
2.6	Safety instructions for Ex areas	6
3	Product description	7
3.1	Configuration.....	7
3.2	Principle of operation.....	8
3.3	Adjustment	8
3.4	Packaging, transport and storage.....	9
4	Mounting	10
4.1	General instructions	10
4.2	Mounting instructions	10
5	Connecting to power supply	13
5.1	Preparing the connection	13
5.2	Sensor input mode active/passive.....	13
5.3	Connection procedure.....	14
5.4	Wiring plan	15
6	Setup with the integrated display and adjustment unit	17
6.1	Adjustment system	17
6.2	Setup steps	18
6.3	Menu schematic.....	29
7	Setup with PACTware	37
7.1	Connect the PC.....	37
7.2	Parameter adjustment with PACTware.....	39
7.3	Setup web server/e-mail, remote enquiry.....	40
8	Application examples	41
8.1	Level measurement in a horizontal cylindrical tank with overfill protection/dry run protection	41
8.2	Pump control 1/2 (run time controlled).....	42
8.3	Pump control 3/4 (sequentially controlled)	46
8.4	Tendency recognition	49
8.5	Flow measurement.....	50
9	Diagnostics and servicing	53
9.1	Maintenance	53
9.2	Rectify faults.....	53
9.3	Diagnosis, fault messages	53
9.4	How to proceed if a repair is necessary.....	55

10 Dismount.....	57
10.1 Dismounting steps.....	57
10.2 Disposal	57
11 Certificates and approvals.....	58
11.1 Approvals for Ex areas	58
11.2 Approvals as overfill protection.....	58
11.3 EU conformity.....	58
11.4 Environment management system	58
12 Supplement	59
12.1 Technical data	59
12.2 Overview applications/functionality	63
12.3 Dimensions	64
12.4 Industrial property rights.....	65
12.5 Trademark	65

1 About this document

1.1 Function

This instruction provides all the information you need for mounting, connection and setup as well as important instructions for maintenance, fault rectification, the exchange of parts and the safety of the user. Please read this information before putting the instrument into operation and keep this manual accessible in the immediate vicinity of the device.

1.2 Target group

This operating instructions manual is directed to trained personnel. The contents of this manual must be made available to the qualified personnel and implemented.

1.3 Symbols used



Document ID

This symbol on the front page of this instruction refers to the Document ID. By entering the Document ID on www.vega.com you will reach the document download.



Information, note, tip: This symbol indicates helpful additional information and tips for successful work.



Note: This symbol indicates notes to prevent failures, malfunctions, damage to devices or plants.



Caution: Non-observance of the information marked with this symbol may result in personal injury.



Warning: Non-observance of the information marked with this symbol may result in serious or fatal personal injury.



Danger: Non-observance of the information marked with this symbol results in serious or fatal personal injury.



Ex applications

This symbol indicates special instructions for Ex applications.



List

The dot set in front indicates a list with no implied sequence.



Sequence of actions

Numbers set in front indicate successive steps in a procedure.



Battery disposal

This symbol indicates special information about the disposal of batteries and accumulators.

2 For your safety

2.1 Authorised personnel

All operations described in this documentation must be carried out only by trained, qualified personnel authorised by the plant operator.

During work on and with the device, the required personal protective equipment must always be worn.

2.2 Appropriate use

VEGAMET 391 is a universal controller for connection of a 4 ... 20 mA sensor.

You can find detailed information about the area of application in chapter " *Product description*".

Operational reliability is ensured only if the instrument is properly used according to the specifications in the operating instructions manual as well as possible supplementary instructions.

2.3 Warning about incorrect use

Inappropriate or incorrect use of this product can give rise to application-specific hazards, e.g. vessel overflow through incorrect mounting or adjustment. Damage to property and persons or environmental contamination can result. Also, the protective characteristics of the instrument can be impaired.

2.4 General safety instructions

This is a state-of-the-art instrument complying with all prevailing regulations and directives. The instrument must only be operated in a technically flawless and reliable condition. The operator is responsible for the trouble-free operation of the instrument. When measuring aggressive or corrosive media that can cause a dangerous situation if the instrument malfunctions, the operator has to implement suitable measures to make sure the instrument is functioning properly.

During the entire duration of use, the user is obliged to determine the compliance of the necessary occupational safety measures with the current valid rules and regulations and also take note of new regulations.

The safety instructions in this operating instructions manual, the national installation standards as well as the valid safety regulations and accident prevention rules must be observed by the user.

For safety and warranty reasons, any invasive work on the device beyond that described in the operating instructions manual may be carried out only by personnel authorised by the manufacturer. Arbitrary conversions or modifications are explicitly forbidden. For safety reasons, only the accessory specified by the manufacturer must be used.

To avoid any danger, the safety approval markings and safety tips on the device must also be observed.

2.5 Installation and operation in the USA and Canada

This information is only valid for USA and Canada. Hence the following text is only available in the English language.

Installations in the US shall comply with the relevant requirements of the National Electrical Code (ANSI/NFPA 70).

Installations in Canada shall comply with the relevant requirements of the Canadian Electrical Code.

2.6 Safety instructions for Ex areas

For applications in explosion-proof areas (Ex), only devices with corresponding Ex approval may be used. Observe the Ex-specific safety instructions. These are an integral part of the operating instructions and are enclosed with every device with Ex approval.

3 Product description

3.1 Configuration

Scope of delivery

The scope of delivery encompasses:

- Controller VEGAMET 391
- Two clamping elements for panel mounting
- Ex separating wall
- Mini-USB cable
- Carrier rail adapter (optional)
- RS232 modem connection cable (optional)
- Documentation
 - This operating instructions manual
 - Supplementary instruction 30325 "RS232/Ethernet connection" (optional)
 - Supplementary instructions manual 30768 "Modbus-TCP, ASCII protocol" (optional)
 - Ex-specific "Safety instructions" (with Ex version)
 - If necessary, further certificates

Constituent parts

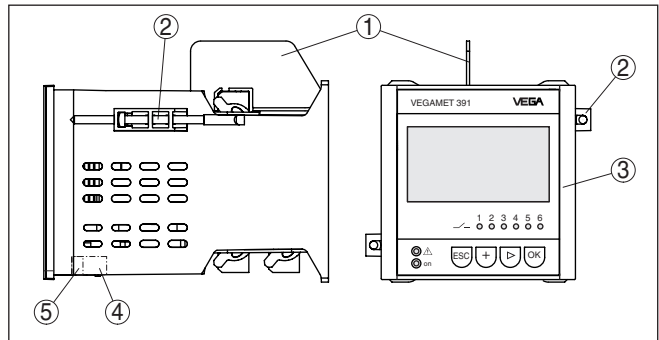

Fig. 1: VEGAMET 391

- 1 Ex separating wall
- 2 Clamping element for panel mounting
- 3 Display and adjustment unit
- 4 RS232 or Ethernet interface (optional)
- 5 USB interface

Type label

The type label contains the most important data for identification and use of the instrument:

- Instrument type
- Information about approvals
- Technical data
- Serial number of the instrument
- QR code for device documentation
- Number code for Bluetooth access
- Manufacturer information

Serial number

The type label contains the serial number of the instrument. With it you can find the following data on our homepage:

- Product code of the instrument (HTML)
- Delivery date (HTML)
- Order-specific instrument features (HTML)
- Operating instructions at the time of shipment (PDF)
- Safety instructions and certificates

Move to "www.vega.com" and enter in the search field the serial number of your instrument.

Alternatively, you can access the data via your smartphone:

- Download the VEGA Tools app from the "*Apple App Store*" or the "*Google Play Store*"
- Scan the DataMatrix code on the type label of the instrument or
- Enter the serial number manually in the app

3.2 Principle of operation

VEGAMET 391 is a universal controller for a variety of applications such as level, gauge and process pressure measurement. At the same time, it can serve as power supply unit for connected sensors. VEGAMET 391 is designed for connection of any 4 ... 20 mA/HART sensor.

On instruments with one of the optional interfaces (RS232/Ethernet), the measured values can be retrieved via modem or network and displayed by means of a web browser or VEGA Inventory System. It is also possible to send measured values and messages via e-mail/SMS. The use of VEGAMET 391 is particularly suitable for stocktaking, VMI (Vendor Managed Inventory) and remote enquiry.

Application area

Functional principle

The VEGAMET 391 controller can power the connected sensor and process its measurement signals. The requested parameter is shown on the display and also output to the integrated current output for further processing. The measurement signal can thus be transferred to a remote display or a superordinate control system. Operating relays for control of pumps or other devices are also integrated.

3.3 Adjustment

The instrument can be adjusted with the following adjustment media:

- With integrated display and adjustment unit
- an adjustment software according to FDT/DTM standard, e.g. PACTware and a Windows PC

The entered parameters are generally saved in VEGAMET 391, when used with PACTware and PC also optionally in the PC.



Information:

When using PACTware and the respective DTM, additional settings can be carried out which are not possible or only partly possible with the integrated display and adjustment unit. Communication is carried out via the integrated USB interface or one of the optional interfaces (RS232/Ethernet).

Further instructions for setting up the web server and e-mail functions can be found in the online help of PACTware or the VEGAMET 391

DTMs as well as the operating instructions manual " *RS232/Ethernet connection*".

3.4 Packaging, transport and storage

Packaging

Your instrument was protected by packaging during transport. Its capacity to handle normal loads during transport is assured by a test based on ISO 4180.

The packaging of standard instruments consists of environment-friendly, recyclable cardboard. For special versions, PE foam or PE foil is also used. Dispose of the packaging material via specialised recycling companies.

Transport

Transport must be carried out in due consideration of the notes on the transport packaging. Nonobservance of these instructions can cause damage to the device.

Transport inspection

The delivery must be checked for completeness and possible transit damage immediately at receipt. Ascertained transit damage or concealed defects must be appropriately dealt with.

Storage

Up to the time of installation, the packages must be left closed and stored according to the orientation and storage markings on the outside.

Unless otherwise indicated, the packages must be stored only under the following conditions:

- Not in the open
- Dry and dust free
- Not exposed to corrosive media
- Protected against solar radiation
- Avoiding mechanical shock and vibration

Storage and transport temperature

- Storage and transport temperature see chapter " *Supplement - Technical data - Ambient conditions*"
- Relative humidity 20 ... 85 %

4 Mounting

4.1 General instructions

Installation possibilities

The instrument is designed for recessed installation in an instrument panel, housing front plate or switching cabinet door. The required cut-out is 92 x 92 mm (3.63 x 3.63 in) according to EN 60529. When installed correctly, protection rating IP65 is guaranteed. As an alternative, the instrument can be mounted in a switching cabinet or protective housing by means of four screws (attached with screws to rear of housing). A mounting adapter for carrier rail mounting is available as an option (top hat rail 35 x 7.5 according to DIN EN 50022/60715).



Note:

If the instrument is mounted via screws or carrier rail, it must always be inside a switching cabinet or protective case.



A VEGAMET 391 in Ex version is an auxiliary, intrinsically safe instrument and may not be installed in explosion-endangered areas.

Before setup, the Ex separating wall must be attached to Ex versions. Safe operation can only be ensured if the operating instructions manual and the EC type approval certificate are observed. VEGAMET 391 must not be opened.

Ambient conditions

The instrument is suitable for standard ambient conditions acc. to DIN/EN/IEC/ANSI/ISA/UL/CSA 61010-1.

Make sure that the degree of contamination specified in chapter "Technical data" meets the existing ambient conditions.

Front panel mounting

4.2 Mounting instructions

1. Make sure that the cut-out required for mounting has a size of 92 x 92 mm (3.63 x 3.63 in).
2. Check for the correct position of the seal directly behind the front plate and insert the instrument from the front into the front panel cut-out.
3. Press the two tensioning elements into the provided gaps.
4. Screw in the two screws of the tensioning elements evenly with a screwdriver.

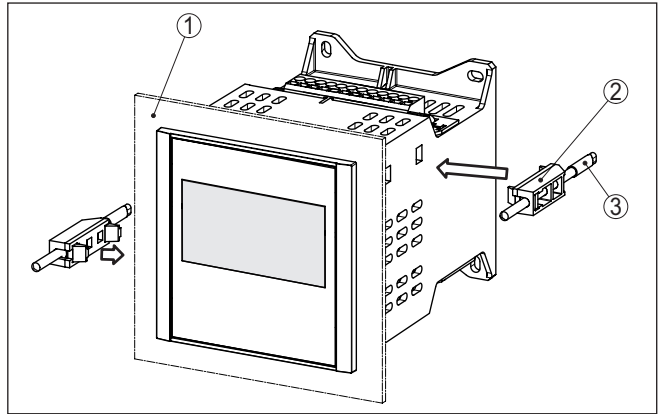

Fig. 2: Front panel mounting

- 1 Front panel, front plate or switching cabinet door
- 2 Clamping elements
- 3 Slotted screw

Screw mounting

→ Fasten the instrument by means of four screws (max. \varnothing 4 mm) to the inner side of the housing or to the mounting plate according to the following illustration.

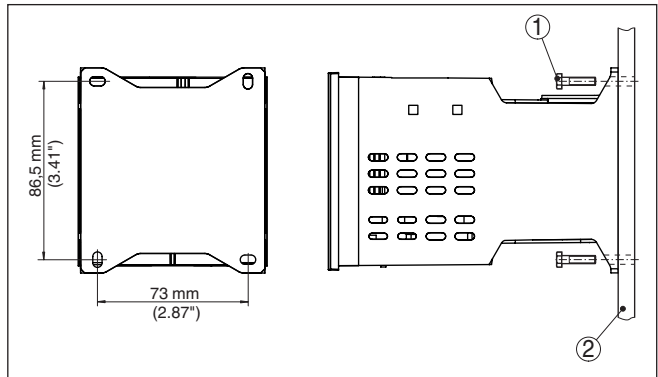

Fig. 3: Screw mounting

- 1 Fixing screw
- 2 Rear of the housing or mounting plate

Carrier rail mounting

1. Fasten the mounting plate to the instrument with the four enclosed hexagon socket screws.
2. Screw the carrier rail adapter to the mounting plate with the four enclosed Phillips-head screws.

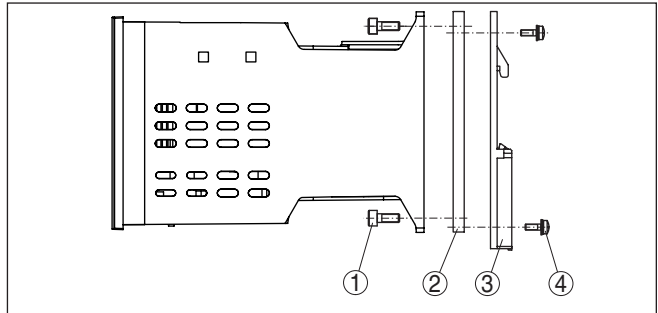

Fig. 4: Carrier rail mounting

- 1 Hexagon socket screws
- 2 Mounting plate
- 3 Carrier rail adapter
- 4 Phillips head screws

5 Connecting to power supply

5.1 Preparing the connection

Safety instructions

Always keep in mind the following safety instructions:



Warning:

Connect only in the complete absence of line voltage.

- Connect only in the complete absence of line voltage
- If overvoltage surges are expected, overvoltage arresters should be installed



Note:

Install a disconnecting device for the instrument which is easy to access. The disconnecting device must be marked for the instrument (IEC/EN 61010).

Safety instructions for Ex applications



In hazardous areas you must take note of the respective regulations, conformity and type approval certificates of the sensors and power supply units.

Voltage supply

The data for power supply are specified in chapter " *Technical data*".

Connection cable

The voltage supply of VEGAMET 391 is connected with standard cable according to the national installation standards.

Standard two-wire cable can be used for connecting the sensors. The screening is absolutely necessary to ensure interference-free operation with HART sensors.

Make sure that the cable used has the required temperature resistance and fire safety for max. occurring ambient temperature

Cable screening and grounding

Connect the cable shielding on both ends to ground potential. In the sensor, the shielding must be connected directly to the internal ground terminal. The ground terminal on the outside of the sensor housing must be connected to the potential equalisation (low impedance).

If potential equalisation currents are expected, the screen connection on the side of VEGAMET 391 must be made via a ceramic capacitor (e. g. 1 nF, 1500 V). The low frequency potential equalisation currents are thus suppressed, but the protective effect against high frequency interference signals remains.

Connection cable for Ex applications



Take note of the corresponding installation regulations for Ex applications. In particular, make sure that no potential equalisation currents flow over the cable screen. In case of grounding on both sides this can be achieved by the use of a capacitor or a separate potential equalisation.

5.2 Sensor input mode active/passive

Through the selection of the terminals, you can choose between active and passive operation of the sensor input.

- In active mode, the controller provides the power for the connected sensors. Power and measurement data are transmitted over the same two-wire cable. This mode is provided for connection of measuring transducers without separate power supply (sensors in two-wire version).
- In passive mode the sensors are not powered, only the measured value is transmitted. This input is for connection of transmitters with their own separate voltage supply (sensors in four-wire version). The VEGAMET 391 can also be looped into the existing circuit like a normal ammeter.

**Note:**

With a VEGAMET 391 in Ex version, the passive input is not available.

5.3 Connection procedure

Move on to electrical connection and proceed as follows:

1. Mount the instrument as described in the previous chapter
2. Remove terminal strip 1 on the upper side of the instrument
3. Connect sensor cable to terminal 1/2 (active input) or 5/6 (passive input)
4. If necessary, connect digital inputs to 8 ... 12
5. Plug terminal strip 1 to the upper side of the instrument
6. Remove terminal strip 2 on the lower side of the instrument
7. Connect power supply (switched off) to terminal 13/14
8. If necessary, connect relays or other outputs
9. Plug in terminal strip 2 on the lower side of the instrument
10. For connection of additional relays to terminal strip 3, you have to proceed as described earlier

The electrical connection is finished.



Remember that with Ex applications, the Ex separating wall must be plugged onto the upper side of the instrument before setup.

5.4 Wiring plan

Wiring plan for two-wire sensor

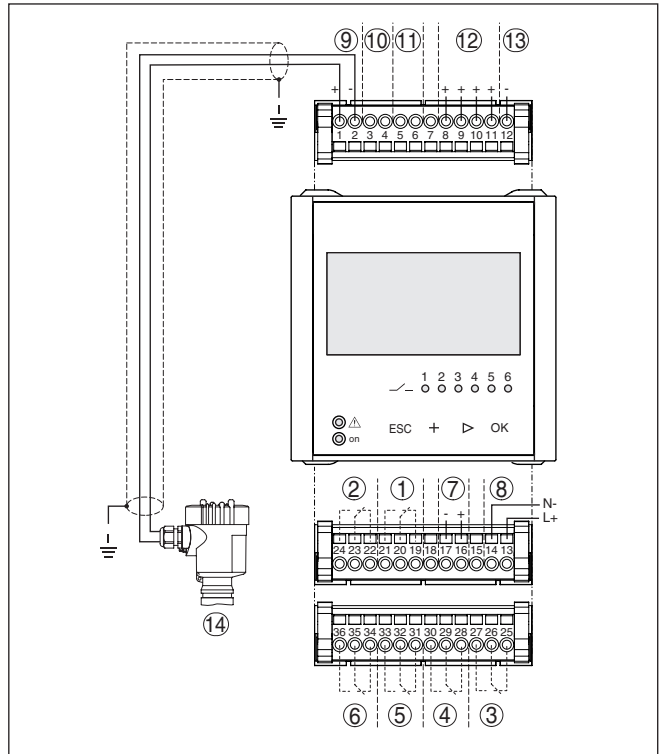

Fig. 5: Wiring plan with two-wire sensor

- 1 Internal relay 1
- 2 Internal relay 2
- 3 Internal relay 3
- 4 Internal relay 4
- 5 Internal relay 5
- 6 Internal relay 6
- 7 4 ... 20 mA current output
- 8 Voltage supply of the controller
- 9 Measurement data input with sensor supply (active input)
- 10 Connection for HART modem for sensor parameter adjustment
- 11 Measurement data input (passive input), not with Ex-ia version
- 12 Digital input 1 ... 4
- 13 Common ground for digital input 1 ... 4
- 14 4 ... 20 mA/HART sensor (two-wire version)

Wiring plan for four-wire sensor

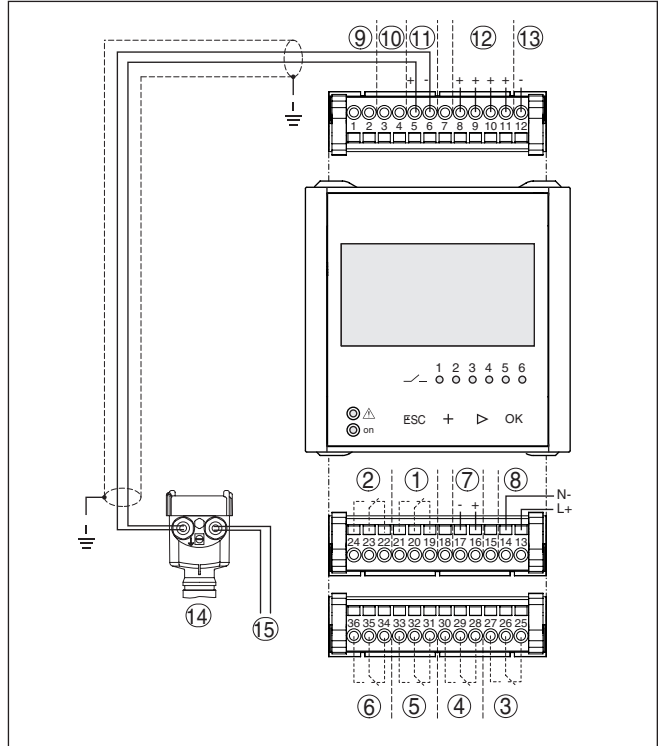

Fig. 6: Terminal assignment with four-wire sensor

- 1 Internal relay 1
- 2 Internal relay 2
- 3 Internal relay 3
- 4 Internal relay 4
- 5 Internal relay 5
- 6 Internal relay 6
- 7 4 ... 20 mA current output
- 8 Voltage supply of the controller
- 9 Measurement data input with sensor supply (active input)
- 10 Connection for HART modem for sensor parameter adjustment
- 11 Measurement data input (passive input), not with Ex-ia version
- 12 Digital input 1 ... 4
- 13 Common ground for digital input 1 ... 4
- 14 4 ... 20 mA/HART sensor (four-wire version)
- 15 Voltage supply for four-wire sensor

6 Setup with the integrated display and adjustment unit

6.1 Adjustment system

Function

The integrated display and adjustment unit is used for measured value display, adjustment and diagnosis of VEGAMET 391. The indication and adjustment are carried out via four keys and a clear, graphic-capable display with background lighting. The adjustment menu with selectable language is clearly structured and enables easy setup.

Certain adjustment options are not available or only partially available with the integrated display and adjustment unit, e.g. the settings for flow measurement. For such applications, the use of PACTware with appropriate DTMs is recommended.

Display and adjustment elements

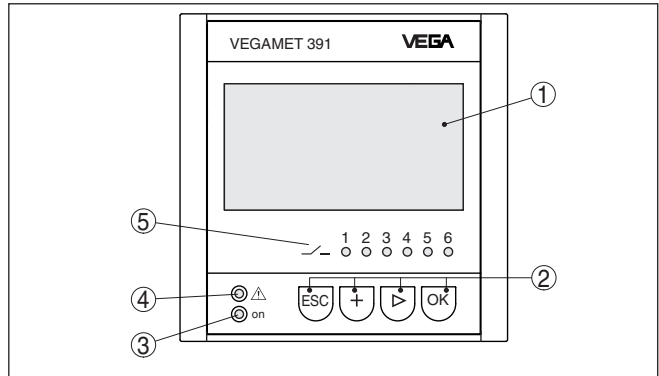

Fig. 7: Display and adjustment elements

- 1 LC display
- 2 Adjustment keys
- 3 Status indication operation
- 4 Status indication fail safe relay
- 5 Status indication, operating relay 1 ... 6

Key functions

Key	Function
[OK]	Entry to the menu level Jump to selected menu item Edit parameter Save value
[>]	Switching between the individual measured value indications Navigation in the menu items Select editing position
[+]	Change parameter values
[ESC]	Jump to next higher menu Interrupt input

6.2 Setup steps

Parameter adjustment

Through parameter adjustment, the instrument is adapted to the individual application conditions. A measurement loop calibration is the most important step and should always be carried out. A scaling of the measured value to the desired physical variable and unit, possibly including a linearisation curve, is often useful. The adaptation of the relay switching points or the setting of an integration time to smooth the measured value are further standard adjustment options.

Instruments with Ethernet interface can be provided with a Host name suitable for the measurement loop. As an alternative to the addressing via DHCP, it is also possible to adjust an IP address and subnet mask suitable for your network. If necessary, the e-mail/Web server can be also configured with PACTware.

A setup assistant is available for easy, convenient setup. It guides the user through the standard applications and settings step by step.



Information:

When using PACTware and the respective DTM, additional settings can be carried out which are not possible or only partly possible with the integrated display and adjustment unit. Communication is carried out via the integrated USB interface or one of the optional interfaces (RS232/Ethernet).

Further instructions for setting up the web server and e-mail functions are stated in the online help of PACTware or the VEGAMET 391 DTMs as well as the supplementary instructions manual "*RS232/Ethernet connection*".

Switch-on phase

After being switched on, VEGAMET 391 first of all carries out a short self-check. The following steps are carried out:

- Internal check of the electronics
- indication of the instrument type, firmware version as well as the instrument TAG (instrument name)
- The output signals jump briefly to the set fault value

Then the current measured values will be displayed and output.

Measured value indication

The measured value indication shows the digitally indicated value, the measurement loop name (measurement loop TAG) and the unit. An analogue bargraph can also be displayed. If flow measurement with totalizer is activated, an additional indication window with totalizers becomes available. If pump control is activated, an additional measured value indication of the assigned pumps is available. By pushing the [**>**] key you can move between the different display options.

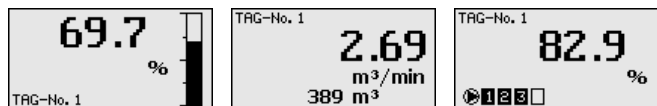

→ By pressing [**OK**], you move from measured value indication to the main menu. Here you can choose between the setup assistant for the most important settings and the complete classic menu.

Main menu/Setup assistant

At the beginning of every setup or parameter adjustment, you have the choice of continuing with the setup assistant or the classic menu guidance. We recommend using the setup assistant for the initial setup. If individual settings need to be corrected or added later, the most expedient way to do this is to use the classic menus.

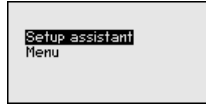

→ Select the menu item " *Setup assistant*" with [->] and confirm with [OK].

Setup assistant

The setup assistant leads you step-by-step through the standard settings. The following steps are carried out:

- Device-TAG (individually adjustable instrument name)
- Measurement loop TAG (individually adjustable measurement loop designation)
- Type of input (4 ... 20 mA or HART)
- Measured variable (for example level or process pressure)
- Adjustment unit (for example m or bar)
- Min./Max. adjustment
- Activation of the fail safe relay
- Configuration of the relay outputs (e.g. setup of pump control or overflow protection)
- Setting Date/Time with option RS232/Ethernet interface
- Network settings with option "Ethernet interface"

When changing the measurement, the assistant can be called up any time. The subsequent steps can also be reached individually via the traditional menu navigation. A description of the individual menu items is available in the traditional menus. In chapter " *Application examples*" you will find further information about setup.

Traditional menu navigation/main menu

The main menu is divided into six areas with the following functions:

- **Device settings:** Includes the device-TAG, settings for network connection such as date/time setting, ...
- **Measurement loop:** Includes settings for input selection, adjustment, damping, linearisation, scaling, outputs, ...
- **Display:** Includes settings for the displayed measured value, language and brightness of the background lighting
- **Diagnosis** Includes information on device status, error messages, input current, digital inputs
- **Further settings:** Includes simulation, reset, PIN, sensor address, ...
- **Info:** Shows serial number, software version, last change, instrument features, MAC addr., ...

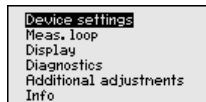

→ Select the requested menu item via the respective keys and confirm with **[OK]**.

Device settings - Device-TAG

You can assign an unambiguous name to VEGAMET 391 via the Device-TAG. This function is recommended when several instruments are implemented and a good documentation of larger systems is required.

Device TAG

Device Name

→ Carry out your settings via the appropriate keys and save with **[OK]**.

Device settings - Host Name/IP addr.

For instruments with integrated Ethernet interface, the automatic addressing via DHCP is preset, i.e. the IP address must be assigned by a DHCP server. Generally the instrument is contacted via the Host name. By default, the host name consists of the serial number plus "VEGA-" in front. As an alternative, it is also possible to enter a static IP addr. with Subnet mask and optional Gateway addr.



Note:

Keep in mind that your modification will be only effective after a restart of VEGAMET 391. You can find further information of these network parameters in the supplementary instructions "RS232/Ethernet connection" and in the Online help of the respective DTM.

Host name

VEGA-10001400

→ Carry out your settings via the appropriate keys and save with **[OK]**.

LAN/Internet

DHCP

IP address

DHCP

Fixed IP address

LAN/Internet

IP address
172.016.003.120

Subnetmask
255.255.000.000

Change?

→ Carry out your settings via the appropriate keys and save with **[OK]**. Disconnect briefly the operating voltage so that the modified settings become effective.

Device settings - Communication protocol

For instruments with integrated RS232 interface, you determine here which mode this serial interface should operate in. The following options are available:

- **VVO protocol:** Direct standard connection between controller and PC for parameter adjustment and enquiry (e.g. with PACTware and DTM)
- **PPP:** Dial-up connection between controller and modem for independent transmission of e-mails (dial-out connection) or enquiry via web browser (dial-in connection)
- **ASCII protocol:** Direct standard connection between controller and PC for enquiry with terminal programs, e.g. Hyperterminal

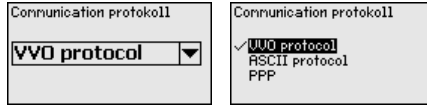

→ Carry out your settings via the respective keys and save with **[OK]**. Further information is available in the supplementary instructions manual "RS232/Ethernet connection" and the online help of the respective DTM.

Device settings - Date/Time

With instruments with integrated RS232/Ethernet interface, the date and time can be entered in this menu item. These time settings are buffered in case of voltage loss via a capacitor as well as as battery up to 10 years.



→ Carry out your settings via the appropriate keys and save with **[OK]**.

Measurement loop - Input

The VEGAMET 391 can process measured values from 4 ... 20 mA/HART sensors via analogue communication as well as via digital HART protocol.

Analogue 4 ... 20 mA transmission

In the standard setting of VEGAMET 391 the measured value transmission is carried out via analogue 4 ... 20 signal. An adjustment in the sensor influences directly the input variable of VEGAMET 391. Only carry out the adjustment on one instrument, either on VEGAMET 391 or on the sensor. The adjustment in VEGAMET 391 is always carried out in mA (analogue transmission).

Digital HART transmission

For transmission via HART, VEGAMET 391 must be informed which sensor value should be used for further processing. Depending on the sensor type, this can be distance, pressure or temperature. With all HART sensors, the unchanged initial value of the sensor is always transmitted to VEGAMET 391. Thus, adjustment must always be carried out on VEGAMET 391, never on the sensor. Different parameters and measuring units are available.

When HART sensors from other manufacturers are connected, the options PV (Primary Value) and SV (Secondary Value) are available. The prerequisite for this is the support of the HART commands 0, 1, 3, and 15. This information and which measured values are transmitted can be found in the operating instructions manual of the respective sensor manufacturer.

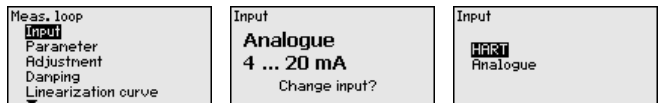

Carry out your settings via the appropriate keys and save with **[OK]**.

Meas. loop - Parameter

The measured variable defines the application of the measurement loop, the following settings are available depending on the connected sensor:

- Level
- Process pressure
- Universal
- Temperature
- Interface
- Flow (only after activating via PACTware or DTM)

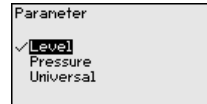
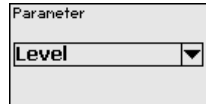

Carry out your settings via the appropriate keys and save with **[OK]**.

Meas. loop - Adjustment

Through the adjustment the input value of the connected sensor is converted into a percentage value. This conversion step allows any input value range to be depicted in a relative range (0 % up to 100 %).

Before carrying out the adjustment, the requested adjustment unit can be selected. With input selection "Analogue", the adjustment unit is always "mA". If the HART input is activated, the available unit depends on the sensor type. With radar, ultrasonic and guided microwave this is always the distance in metres or feet "m(d)" or "ft(d)", and with pressure transmitters it is e.g. "bar" or "psi".

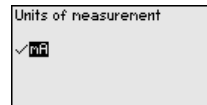
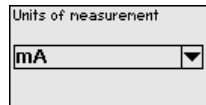

The following illustrations and examples relate to the min./max. adjustment of a radar sensor with HART communication.

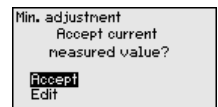
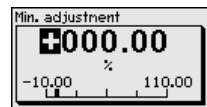
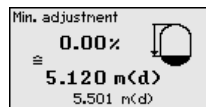

- With **[OK]** you prepare the percentage value for editing, with **[->]** you place the cursor to the requested position. Set the requested percentage value with **[+]** and save with **[OK]**.
- After entering the percentage value for the min. adjustment, the suitable distance value must be entered. If you want to use the currently measured distance value, select the menu item "Accept" (live adjustment or adjustment with medium). If the adjustment should be carried out independent of the measured level, then select the option "Edit". Enter now the distance value in m [m(d)] for the empty vessel that is suitable for the percentage value, e.g. distance from the sensor to the vessel bottom (dry adjustment or adjustment without medium).
- Save your settings with **[OK]** and move to "Max. adjustment" with **[->]**.

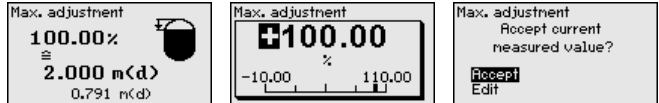

- As described previously, enter now the percentage value for max. adjustment and confirm with **[OK]**.
- After entering the percentage value for the max. adjustment, the suitable distance value must be entered. If you want the use the currently measured distance value, select the menu item "Accept" (live adjustment or adjustment with medium). If the adjustment should be carried out independent of the measured level, then select the option "Edit". Enter now the distance value in m [m(d)] for the full vessel that is suitable for the percentage value (dry adjustment or adjustment without medium). Keep in mind that the max. level must be below the radar antenna.
- Finally save your settings with **[OK]**, the adjustment is finished.

Meas. loop - Damping

To suppress fluctuations in the measured value display, e.g. caused by an agitated medium surface, an integration time can be set. This time can be between 0 and 999 seconds. Remember that the reaction time of the entire measurement will then be longer and the sensor will react to measured value changes with a delay. In general, a period of a few seconds is sufficient to smooth the measured value display.

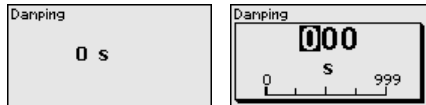

→ Carry out your settings via the appropriate keys and save with **[OK]**.

Meas. loop - Linearization curve

A linearisation is necessary for all vessels in which the vessel volume does not increase linearly with the level, for example a horizontal cylindrical or spherical tank. Corresponding linearisation curves are preprogrammed for these vessels. They represent the correlation between the level percentage and vessel volume. By activating the appropriate curve, the volume percentage of the vessel is displayed correctly. If the volume should not be displayed in percent but e.g. in l or kg, a scaling can be also set.

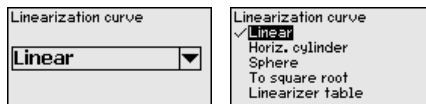

→ Carry out your settings via the appropriate keys and save with **[OK]**.

Meas. loop - Scaling

Scaling means converting the measured value into a certain parameter and unit. The linearized percentage value is the source signal which is used as basis for the scaling. The indication can then show the volume in litres e.g., instead of the percentage value. Indication values from max. -99999 to +99999 are possible.

Scaling units <input type="text" value="Other"/> <input type="text" value="‰"/>	Scaling units Flow Volume <input type="text" value="Other"/> Temperature	Scaling 100% = 100.00 % 0% = 0.00 %
---	---	---

→ Carry out your settings via the appropriate keys and save with **[OK]**.

Meas. loop - Meas. loop TAG

In this menu item you can enter an unambiguous designation for each measurement loop, e.g. the measurement loop name or the tank or product designation. In digital systems and in the documentation of larger plants, a singular designation should be entered for exact identification of individual measuring points.

Meas. loop TAG TAG-No. 1
--

→ Carry out your settings via the appropriate keys and save with **[OK]**.

Meas. loop - Outputs - Relays outputs

Under "Outputs" you can find the relay and current outputs. Six relays are available for use. Relay 1 is assigned to the measurement loop. Relays 2 ... 5 are available and not yet assigned to a function. The relays must be activated before they can be used.

To configure the relay output, the requested mode ("Overfill protection/Dry run protection" or "Pump control") must first be selected.

- **Overfill protection:** Relay is switched off when the max. level is exceeded (safe currentless state), relay is switched on again when the level falls below the min. level (switch-on point < switch-off point)
- **Dry run protection:** Relay is switched off when the level falls below the min. level (safe currentless state), relay is switched on again when the max. level is exceeded (switch-on point > switch-off point)
- **Pump control:** With several pumps having the same function, the pumps will be alternately switch on and off according to the adjustable criteria

Additional modes such as "Switching window", "Flow" and "Tendency" can be only adjusted via PACTware and DTM.

Relay 6 can be also configured as fail safe relay. The following example shows the setting of an overfill protection. Further information to pump control, tendency recognition or flow measurement are available in chapter "Application examples".

Outputs <input type="text" value="Relay output"/> Current output	Relay output <input type="text" value="Relay 1"/> Relay 2 Relay 3 Relay 4 Relay 5	Relay 1 <input type="text" value="activated"/>
--	--	---

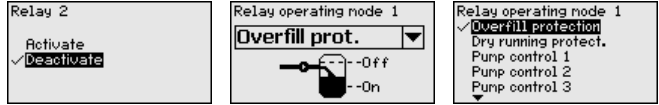

Select the requested mode and save with [OK]. By pushing [→], you reach the next menu item.

Now enter the reference value to which the relay switching points relate. By pushing [→], you reach the next menu item.

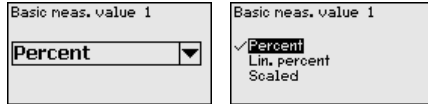

Now enter the switching points for switching the relay on and off.

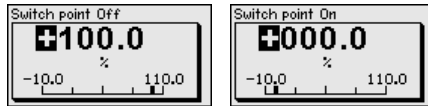

In the following window the reaction of the relay in case of failure can be determined. Here you can define whether, in case of failure, the switching condition of the relay remains unchanged or the relay is switched off.

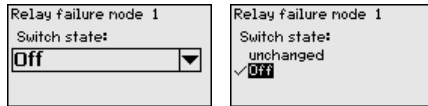

Meas. loop - Outputs - Current output

The current output is used to transfer the measured value to a higher ranking system, for example to a PLC, a control system or a measured value indication. This is an active output, i.e. a current is provided actively. The processing unit must hence have a passive current input. The characteristics of the current output can be set to 0 ... 20 mA, 4 ... 20 mA or inverted. The reaction in case of failure can also be adapted to the requirements. The measured variable you refer to can also be selected.

→ Carry out your settings via the appropriate keys and save with [OK].

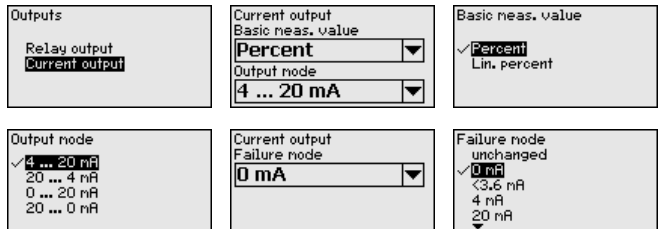

Display - Indicated value

In the menu item "Display - Indication value", you can set the requested indication value. The following options are available:

- **Percent:** adjusted measured value without taking a saved linearisation into account
- **Lin. percent:** adjusted measured value taking a saved linearisation into account
- **Scaled:** adjusted measured value taking a saved linearisation into account as well as the values entered under "Scaling"
- **Sensor value:** input value delivered by the sensor. Displayed in the selected adjustment unit

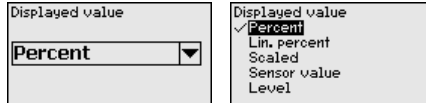

→ Carry out your settings via the appropriate keys and save with **[OK]**.

Display - Language

In the menu item "Display - Language", the requested display language can be adjusted. The following languages are available:

- German
- English
- French
- Spanish
- Russian
- Italian
- Dutch

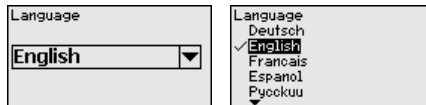

→ Carry out your settings via the appropriate keys and save with **[OK]**.

Display - Brightness

In the menu item "Display - Brightness", the brightness of the background lighting can be continuously adjusted.



→ Carry out your settings via the appropriate keys and save with **[OK]**.

Diagnostics

When the instrument displays a fault, further information about the fault can be called up via the menu item "Diagnosis - Device status". Furthermore, the input current, the sensor status and the input status of the digital inputs can be displayed. The status of the relay, its switched-on period and the number of switch-on events can also be displayed. The counters can also be reset.

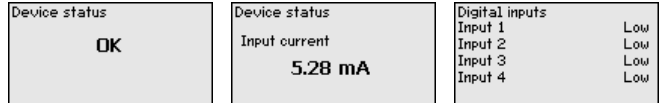

Additional adjustments - Simulation

The simulation of a measured value is used to check the outputs and connected components. The simulation can be applied to the percentage value, the lin. percentage value and the sensor value.



Note:

Please note that connected system components (valves, pumps, motors, control systems) are influenced by the simulation, thus unintentional plant operating conditions can occur. The simulation is terminated automatically after approximately 10 minutes.

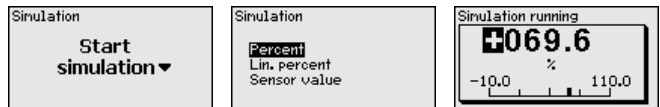

→ Carry out your settings via the appropriate keys and save with **[OK]**.

Additional settings - Reset

Several reset options are available. A reset to basic settings resets all settings (with a view exceptions) to default. Exceptions are: host name, IP address, subnet mask, time, language. Further possibilities are reset of the totalizer as well as the power-on time and relay failure. The instrument can also be restarted if desired.

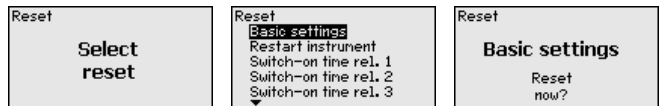

Additional adjustments - Access protection

The controller can be locked and the data transmission encrypted as a protection against unauthorized changes of the set parameters. The following options are possible:

- Access protection of the on-site adjustment via keyboard by means of a PIN
- Access protection of the DTM adjustment via the USB/Ethernet/RS232 interface by means of a password (can be only activated via DTM)
- Encryption of the DTM data transmission with connection via Ethernet/RS232 interface
- Access protection of the integrated web server by means of a password (can be only activated via DTM)

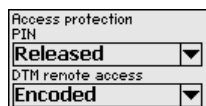

Additional adjustments - Access protection - PIN

Modification of parameters through the instrument keyboard can be avoided by activating a PIN. The measured value display and display of all parameters is still possible.



Note:

By activating the PIN, only parameter changes via the front side instrument keyboard are locked. Via the interfaces and the respective DTM, the complete access to the instrument is still possible. If you want to stop this access, then the DTM adjustment can be completely locked by activating a password. The activation of this locking only possible via the DTM and not via the keyboard.

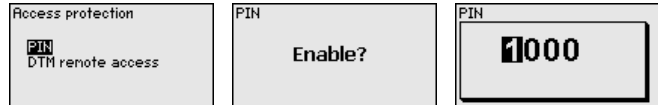

Additional adjustments - Access protection - DTM remote access

Instruments with RS232/Ethernet option can be protected against wiretapping and manipulation of the data transmission from remote. For this, activate under "DTM remote access" the encryption of the data transmission. With active encryption, it is necessary to enter once the instrument key (PSK) during connection for DTM access via the Ethernet/RS232 interface. The instrument key is stored on the PC and must not be entered again when connecting with this PC. Each instrument is provided with an individual instrument key consisting of 20 capital letters. This key can be read out directly on the instrument display in the menu "Info".

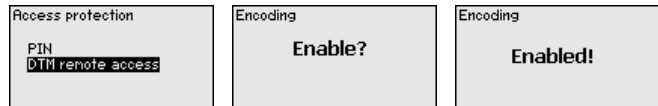

Additional adjustments - Sensor address

With every 4 ... 20 mA/HART sensor, the measured value can be transmitted via analog current signal or digital HART signal. This is regulated via the HART mode or the address. If a HART sensor is set to address 0, the sensor is in the standard mode. Here the measured value is transmitted digitally on the 4 ... 20 mA cable.

In mode HART Multidrop, an address from 1 ... 15 is assigned to the sensor. By doing so, the current is fixed limited to 4 mA and the measured value transmission is only made digitally.

Via the menu item "Sensor address", the address of the connected sensor can be modified. For this purpose, you have to enter the address of the connected sensor (default setting 0) and in the next window the new address.



Additional adjustments - Data transmission

With instrument versions with integrated RS232/Ethernet interface, a manual data transmission to a VEGA Inventory System can be

triggered, e.g. for test purposes. The one requirement is that such an event has been configured in advance via PACTware/DTM.

Data transfer Send VEGA Invent. Sys data?	Data transfer Trigger data transfer?	Status data transfer Message transmission is being prepared
---	--	---

Info

In the menu item "Info" the following information is available:

- Sensor type and serial number
- Software and hardware version
- Date of manufacture and date of the last change using PC
- Features of VEGAMET 391
- MAC address (with interface option Ethernet)
- Instrument key (PSK) for DTM remote access (with interface option Ethernet/RS232)

Sensor type VEGAMET 391 Serial number 10001400	Software version 1.30 Hardware version 1.00.09	Date of manufacture 14. Aug 2012 Date of last change using PC 14. Aug 2012
---	---	--

Optional settings

Additional adjustment and diagnostics options are available via the Windows software PACTware and the suitable DTM. Connection can be made optionally via the built-in standard interface or one of the optionally offered interfaces (RS232/Ethernet). Further information is available in chapter "Parameter adjustment with PACTware", in the online help of PACTware or the DTM as well as in the operating instructions manual "RS232/Ethernet connection". An overview of the standard functions and their adjustment options can be found in chapter "Functional overview" in the "Supplement".

6.3 Menu schematic



Information:

Depending on the instrument version and application, the highlighted menu windows are not always available.

Measured value indication

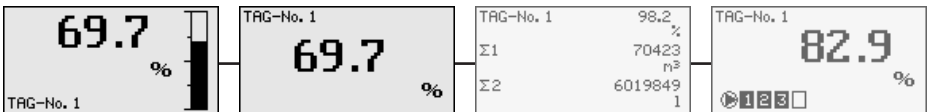

Setup assistant

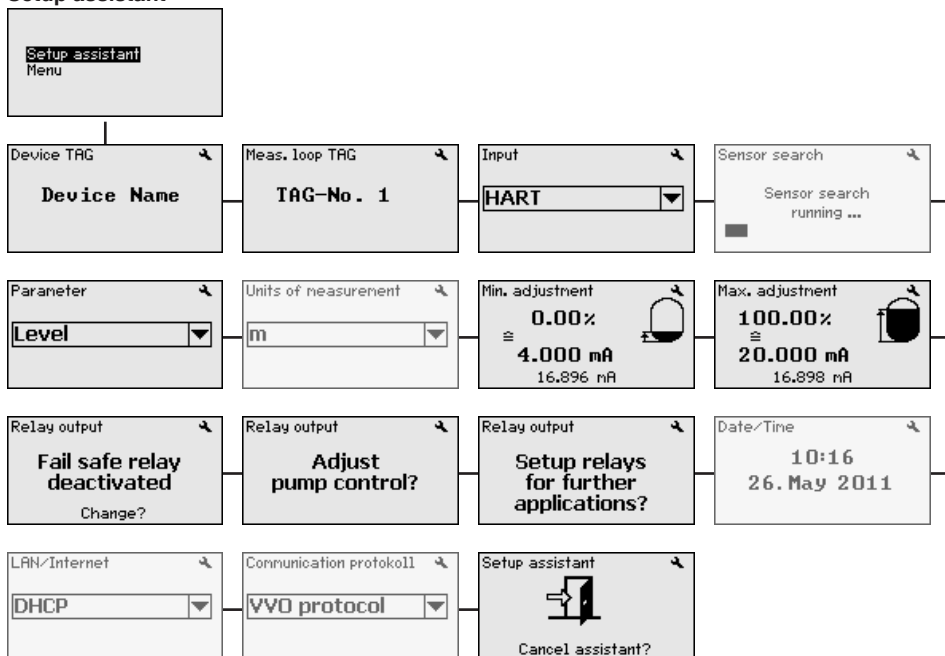

Device settings

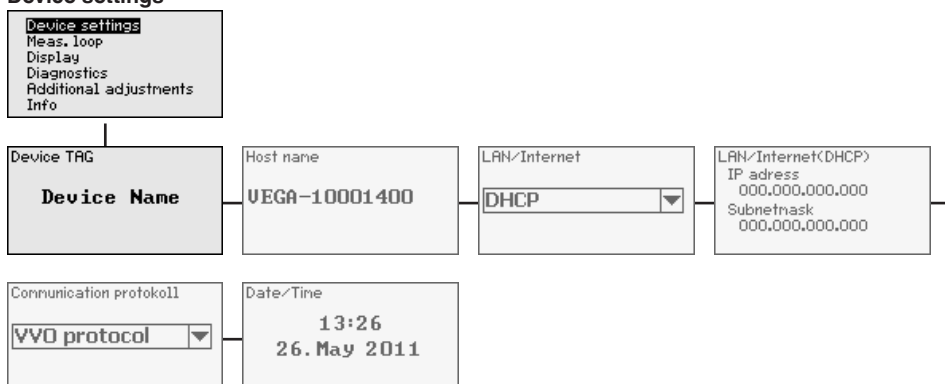

Measurement loop - Input

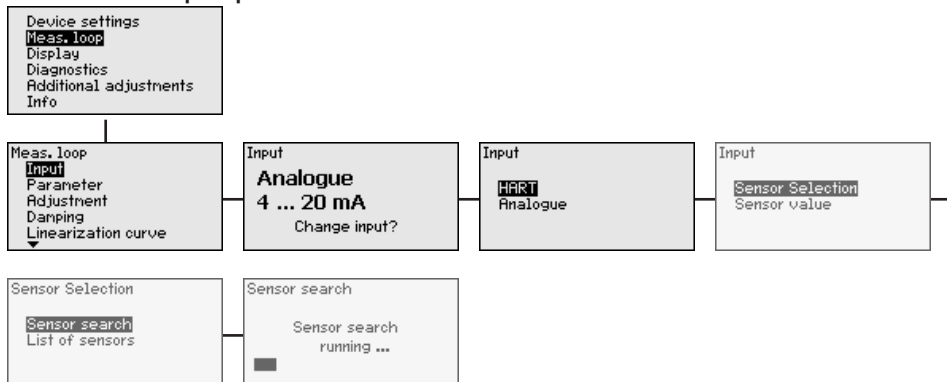

Meas. loop - Parameter

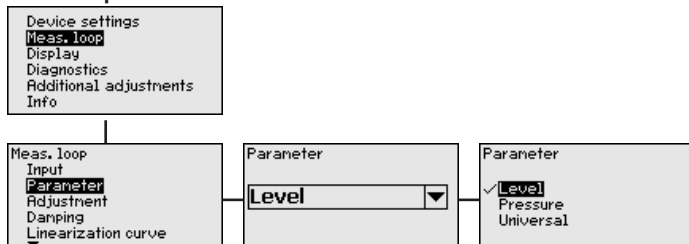

Meas. loop - Adjustment

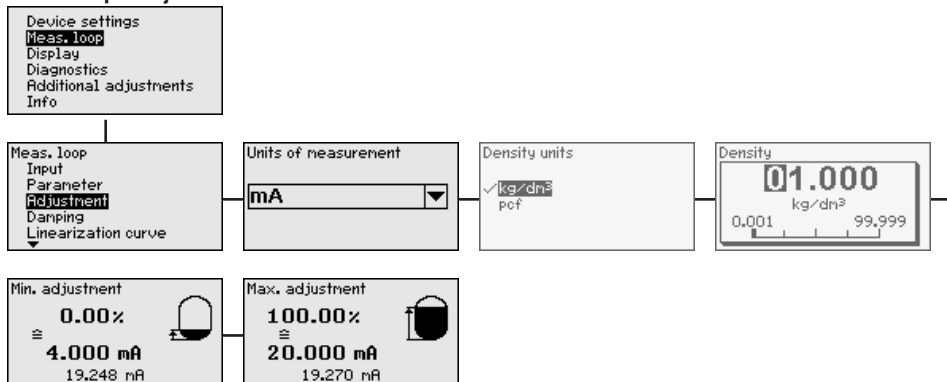

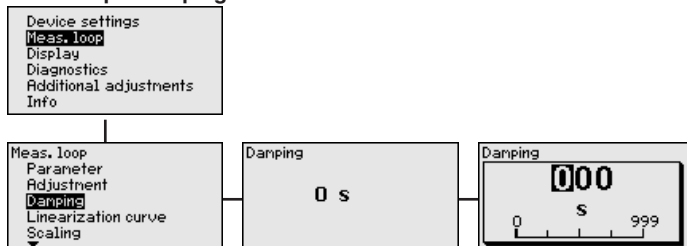
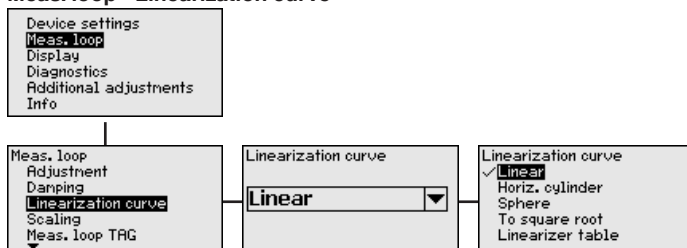
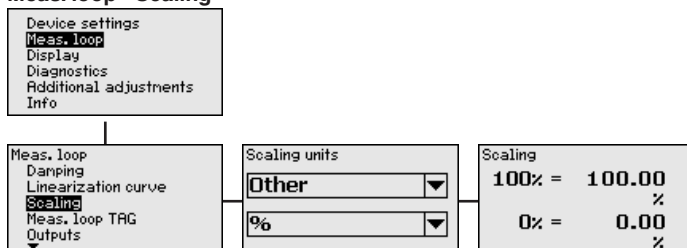
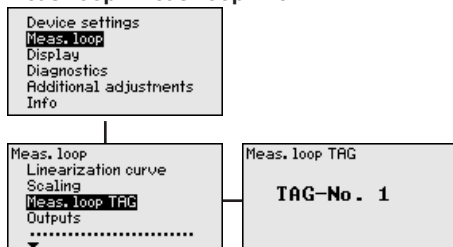
Meas. loop - Damping**Meas. loop - Linearization curve****Meas. loop - Scaling****Meas. loop - Meas. loop TAG**

Meas. loop - Outputs - Relay

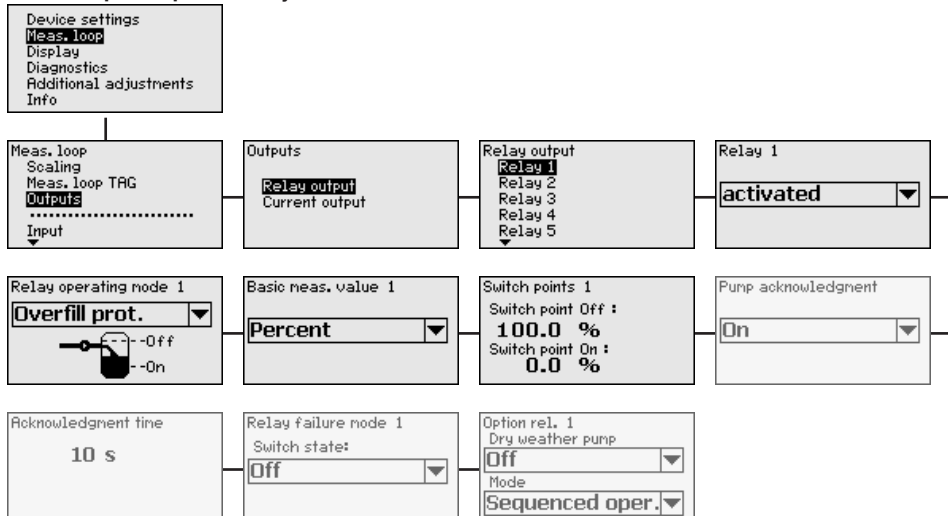

Meas. loop - Outputs - Current output

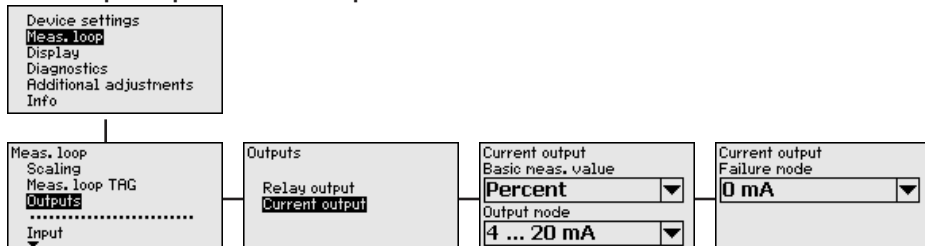

Display

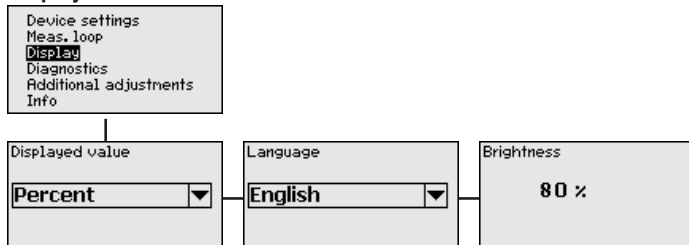

Diagnostics

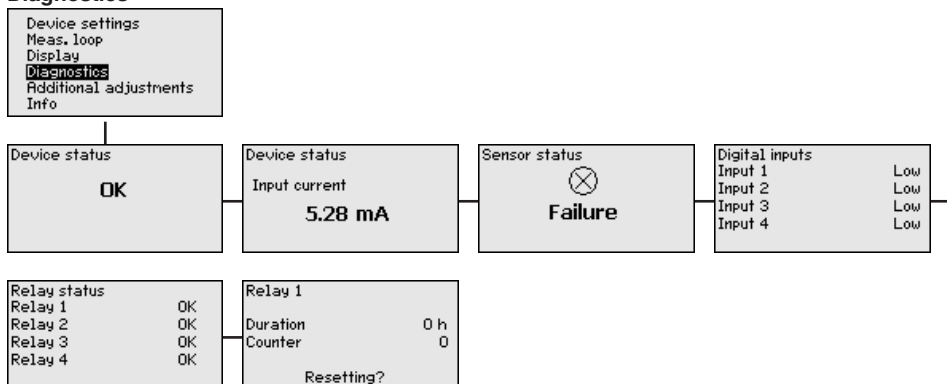

Additional adjustments - Simulation

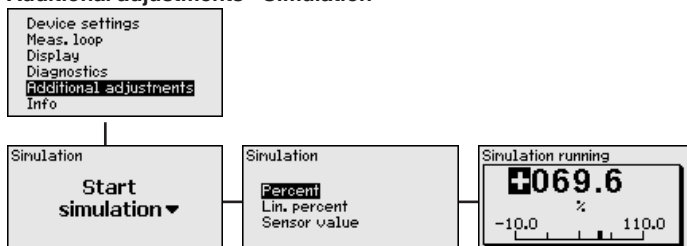

Additional settings - Reset

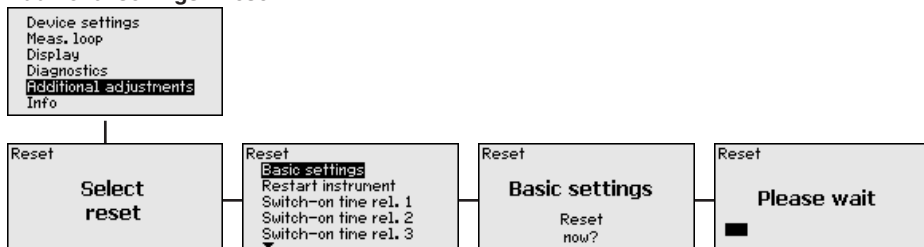

Additional adjustments - Access protection - PIN

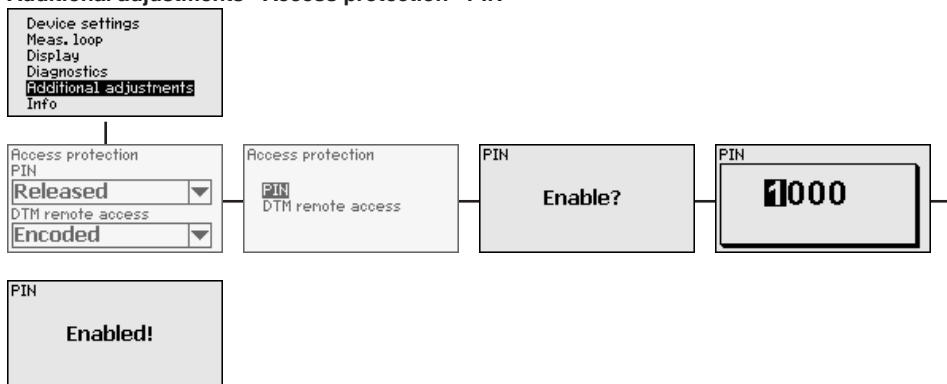

Additional adjustments - Change sensor address

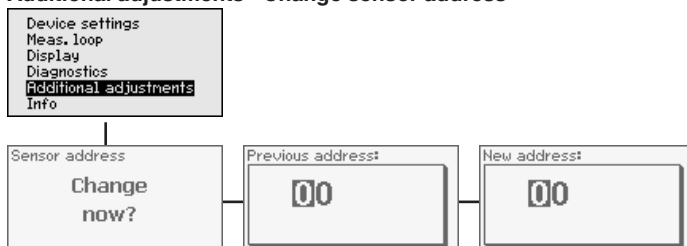

Additional settings - Data transmission (only with option RS232/Ethernet interface)

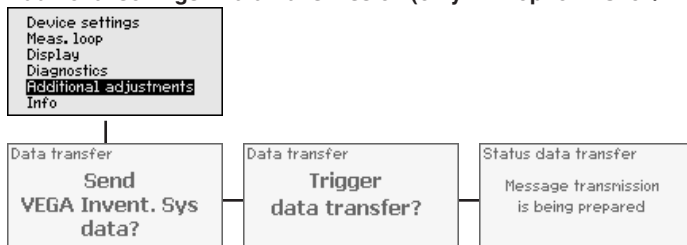

Info

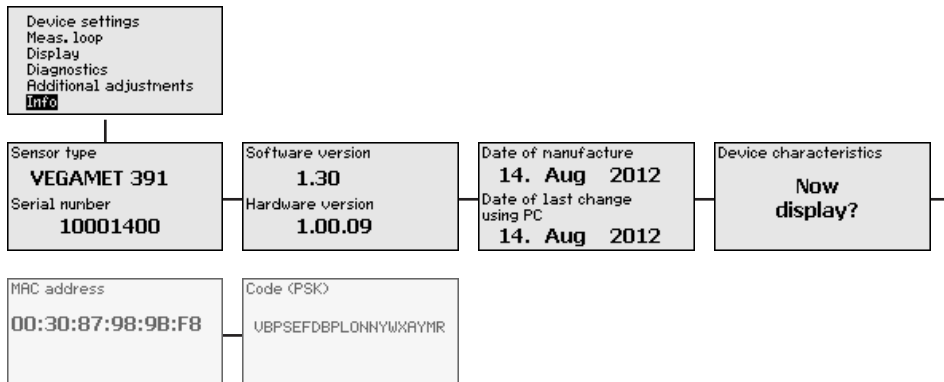

7 Setup with PACTware

7.1 Connect the PC

Connection of the PC via USB

For a brief connection to the PC, for example for parameter adjustment, you should use the USB interface. The required connection socket is on the lower side of all instrument versions. Keep in mind that correct functioning of the USB interface is only guaranteed in the (limited) temperature range of 0 ... 60 °C.



Note:

The connection via USB requires a driver. First install the driver before connecting VEGAMET 391 to the PC.

The required USB driver is included on the CD "DTM Collection". You should always use the latest version to ensure support of all instrument functions. The system requirements for operation correspond to those of the "DTM Collection" or of PACTware.

During installation of the driver package "DTM for Communication", the suitable instrument driver is installed automatically. When VEGAMET 391 is connected, the driver installation is completed autonomously and is ready for operation without a restart.

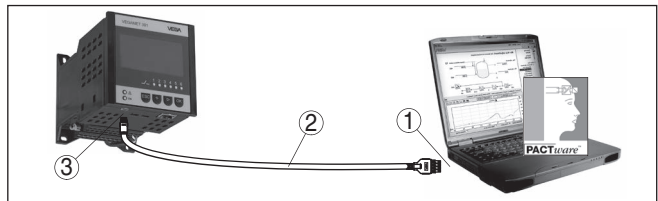

Fig. 8: Connection of the PC via USB

- 1 USB interface of the PC
- 2 Mini-USB connection cable (in the scope of delivery)
- 3 USB interface of VEGAMET 391

Connection of the PC via Ethernet

With the Ethernet interface, the instrument can be connected directly to an existing PC network. Any standard patch cable can be used. A cross-over cable must be used when connecting the instrument directly to the PC. To reduce EMC interferences, the supplied split ferrite should be connected to the Ethernet cable. Each instrument can then be accessed from anywhere in the network by a unique Host name or its own IP address. The parameter adjustment of the instrument via PACTware and DTM can be carried out from any PC. The measured values can be made available to individual users within the company network as HTML chart. As an alternative, the independent, time or event-controlled transmission of measured values via e-mail is also possible. The measured values can also be called up via a visualisation software.



Note:

To contact the instrument, the IP address or the Host name must be known. You can find this information under the menu item "Device settings". If you modify these entries, the instrument has to be restarted afterwards. Then the instrument can be reached from eve-

rywhere in the network via its IP address or Host name. These specifications must also be entered in the DTM (see chapter "Parameter adjustment with PACTware"). If the encrypted DTM remote access is activated in the controller, the instrument key (PSK) must be entered during the first connection. This key can be read out via the on-site adjustment in the info menu of the controller.

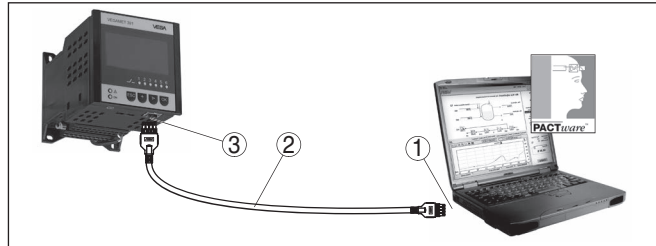

Fig. 9: Connection of the PC via Ethernet

- 1 Ethernet interface of the PC
- 2 Ethernet connection cable (Cross-Over cable)
- 3 Ethernet interface

Connection of the modem via RS232

The RS232 interface is particularly suitable for simple modem connection. External analog, ISDN and GSM modems with standard interface can be used. The necessary RS232 modem connection cable is included with the delivery. To reduce EMC interference, you should mount the supplied ferrite bead on the RS232 modem connection cable. Via a visualisation software, measured values can be retrieved remotely and further processed. Alternatively, autonomous time or event controlled transmission of measured values via e-mail is also possible. Remote parameter adjustment of the instrument and the connected sensors is also possible with PACTware.

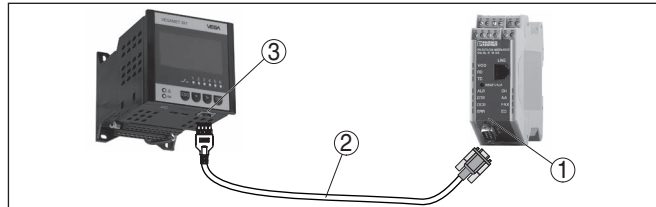

Fig. 10: Connection of the modem via RS232

- 1 Analogue, ISDN or GSM modem with RS232 interface
- 2 RS232 modem connection cable (in the scope of delivery)
- 3 RS232 interface (RJ45 plug connection)

Connection of the PC via RS232

Via the RS232 interface, direct parameter adjustment and measured value retrieval from the instrument can be carried out with PACTware. Use the RS232 modem connection cable supplied with the instrument and an additionally connected null modem cable (e.g. article no. LOG571.17347). To reduce EMC interference, you should mount the supplied ferrite bead on the RS232 modem connection cable.

If there is no RS232 interface available on the PC or if it is already occupied, you can also use a USB-RS232 adapter (e.g. article no. 2.26900).

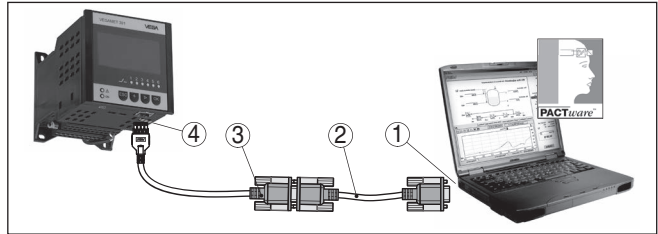

Fig. 11: Connection of the PC via RS232

- 1 RS232 interface of the PC
- 2 RS232 interlink cable (article no. LOG571.17347)
- 3 RS232 modem connection cable (in the scope of delivery)
- 4 RS232 interface (RJ45 plug connection)

Assignment RS232 modem connection cable

①		
RXD	4	2
TXD	3	3
RTS	6	7
CTS	2	8
GND	5	5
DTR	1	4

Fig. 12: Connection assignment of the RS232 modem connection cable

- 1 Name of the interface cable
- 2 Assignment of the RJ45 plug (view of contact side)
- 3 Assignment of the RS232 plug (view of soldering side)

7.2 Parameter adjustment with PACTware

Prerequisites

As an alternative to the integrated display and adjustment unit, the adjustment can be also carried out via a Windows PC. For this, the configuration software PACTware and a suitable instrument driver (DTM) according to the FDT standard are required. The current PACTware version as well as all available DTMs are compiled in a DTM Collection. Furthermore, the DTMs can be integrated into other frame applications compliant with the FDT standard.

**Note:**

To ensure that all instrument functions are supported, you should always use the latest DTM Collection. Furthermore, not all described functions are included in older firmware versions. You can download the latest instrument software from our homepage. A description of the update procedure is also available in the Internet.

Further setup steps are described in the operating instructions manual "*DTM Collection/PACTware*" attached to each DTM Collection and which can also be downloaded from the Internet. A detailed description is available in the online help of PACTware and the DTMs as well as in the supplementary instructions manual "*RS232/Ethernet connection*".

Connection via Ethernet

To contact the instrument, the IP address or the Host name must be known. You can find this information under the menu item "*Device settings*". If the project setup is carried out without assistant (offline mode), IP address and subnet mask or the Host name must be entered in the DTM. Click in the project window with the right mouse key on the Ethernet DTM and choose "*Add. functions - Modify DTM addresses*". If the encrypted DTM remote access is activated in the controller, the instrument key (PSK) must be entered during the first connection. This key can be read out via the on-site adjustment in the info menu of the controller.

Standard/Full version

All device DTMs are available as a free-of-charge standard version and as a full version that must be purchased. In the standard version, all functions for complete setup are already included. An assistant for simple project configuration simplifies the adjustment considerably. Saving/printing the project as well as import/export functions are also part of the standard version.

In the full version there is also an extended print function for complete project documentation as well as a save function for measured value and echo curves. In addition, there is a tank calculation program as well as a multiviewer for display and analysis of the saved measured value and echo curves.

7.3 Setup web server/e-mail, remote enquiry

Setup and application examples of the web server, the e-mail functions and the visualisation VEGA Inventory System are provided in the supplementary instructions "*RS232/Ethernet connection*".

The connection via Modbus-TCP or ASCII protocol is described in the supplementary instruction manual "*Modbus-TCP, ASCII protocol*".

Both supplementary instruction manuals are included with every instrument with RS232 or Ethernet interface.

8 Application examples

8.1 Level measurement in a horizontal cylindrical tank with overflow protection/dry run protection

Functional principle

The level is detected by a sensor and transmitted to the controller by means of a 4 ... 20 mA signal. Here, an adjustment is carried out, converting the input value delivered by the sensor into a percentage value.

Due to the geometrical form of the horizontal cylindrical tank, the vessel volume does not increase linearly with the level. This can be compensated by selecting the linearisation curve integrated in the instrument. This curve states the relationship between percentage level and vessel volume. If the level is to be displayed in litres, a scaling must also be carried out. For this purpose, the linearised percentage value is converted into a volume, for example with the unit litre.

Filling and emptying are controlled via relay 1 and 2 which are integrated in the controller. During filling, relay mode "Overflow protection" is set. The relay is thus switched off (safe currentless state) when the max. level is exceeded, and switched on again when the min. level is underrun (switch-on point < switch-off point). During emptying, mode "Dry run protection" is used. This relay is thus switched off when the min. level is underrun (safe currentless condition), and switched on again when the max. level is exceeded (switch-on point > switch-off point).

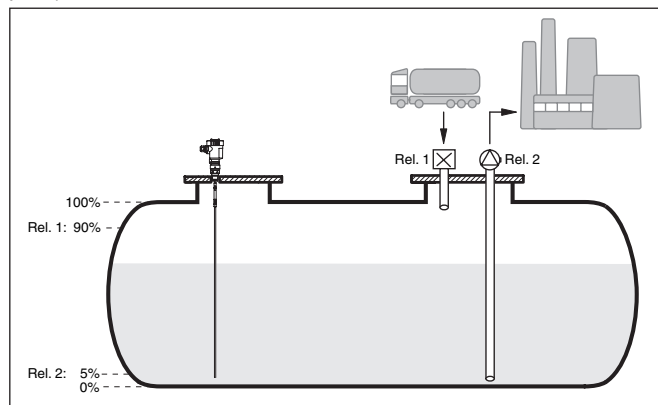

Fig. 13: Example of level measurement, horizontal cylindrical tank

Example

A horizontal cylindrical tank has a capacity of 10000 litres. The measurement is carried out with a level sensor operating according to the guided microwave principle. The filling by a tank car is controlled via relay 1 and a valve (overflow protection). The discharge is carried out via a pump and is controlled by relay 2 (dry run protection). The max. volume should be at 90 % level, this means 9538 litres with a stand-

ard vessel (according to sounding table). The min. level should be set to 5 %, this corresponds to 181 litres. The volume is to be displayed in litres.

Adjustment

Carry out the adjustment in the controller as described in chapter "Setup steps". No further adjustment may be carried out in the sensor itself. For the max. adjustment, fill the vessel up to the requested max. level and accept the actually measured value. If this is not possible, the corresponding current value can also be entered. For the min. adjustment, empty the vessel down to the min. level or enter the corresponding current value.

Linearisation

To display the percentage level correctly, select under "Measurement loop - Linearization curve" the entry "Horiz. cylindrical tank".

Scaling

To display the volume in litres, you have to enter "Volume" as the unit in litres under "Measurement loop - Scaling". The allocation is then carried out, in this example 100 % \triangleq 10000 litres and 0 % \triangleq 0 litres.

Relay

Percent is selected as reference value for the relays. The mode of relay 1 is set to overflow protection, relay 2 must be activated and gets mode dry run protection. To ensure that the pump switches off in case of failure, the reaction in case of failure should be set to switching status OFF. The switching points are set as follows:

- **Relay 1:** Switch-off point 90 %, switch-on point 85 %
- **Relay 2:** Switch-off point 5 %, switch-on point 10 %



Information:

The switch-on and switch-off point of the relays must not be set to the same switching point because this would cause a continuous switching on and off when this threshold is reached. To avoid this effect also with fluctuating medium surfaces, it is a good idea to set a difference (hysteresis) of 5 % between the switching points.

8.2 Pump control 1/2 (run time controlled)

Functional principle

Pump control 1/2 is used to control several pumps with the same function, in dependence on their respective elapsed running times. The pump with the shortest elapsed running time is switched on and the pump with the longest running time switched off. In case of increased pumping requirement, all pumps can also run at the same time, in dependence on the entered switching points. This measure achieves an even utilization of the pumps and increases operational reliability.

All relays with activated pump control are switched on or off depending on the accumulated operating time. The controller selects the relay with the shortest elapsed operating time when the switch-on point is reached and the relay with the longest elapsed operating time when the switch-off point is reached.

Pump fault messages can also be processed via the digital inputs.

This pump control system offers two different options:

- **Pump control 1:** The upper switching point determines the switch-off point for the relay, whereas the lower switching point determines the switch-on point
- **Pump control 2:** The upper switching point determines the switch-on point for the relay, whereas the lower switching point determines the switch-off point

Example

Two pumps should empty the vessel when a certain level is reached. At 80 % filling, the pump with the shortest elapsed running time should switch on. If the level nevertheless increases, a second pump should switch on at 90 %. Both pumps should switch off again at 10 % filling.

Setup

Select in the DTM navigation section the menu items " *Meas. loop - Outputs - Relay*".

- Set mode " *Pump control 2*" for relay 1 and 2 with the option " *Sequenced operation*".
- Enter the switching points for the affected relays as follows:
 - Relay 1 upper switching point = 80.0 %
 - Relay 1 lower switching point = 10.0 %
 - Relay 2 upper switching point = 90.0 %
 - Relay 2 lower switching point = 10.0 %

The function of pump control 2 is shown in detail in the following diagram. The previously described example is used as a basis.

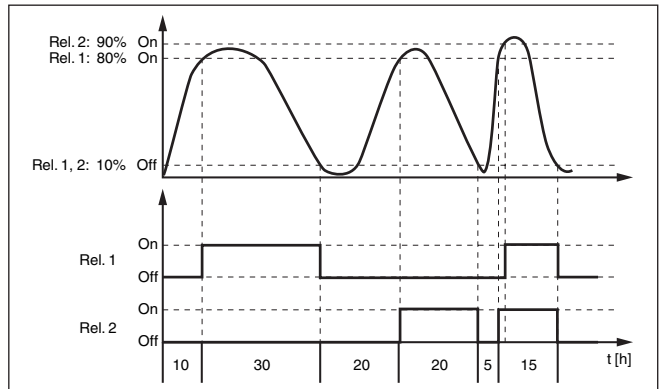

Fig. 14: Example of pump control 2

Display indication

When pump control is activated, the assigned relays and possible pump malfunctions are also displayed in the measured value indication.

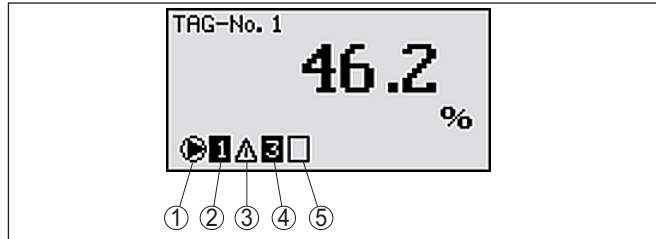

Fig. 15: Display indication of a pump control

- 1 Symbol, activated pump control
- 2 Relay 1 is assigned to the pump control
- 3 Relay 2 is assigned to the pump control and signals failure
- 4 Relay 3 is assigned to the pump control
- 5 Relay 4 is free i.e. not assigned to the pump control

Option Dry weather pump

Pump control 2/4 with dry weather pump is used to protect e.g. rain retention basins with different sized pumps against overflowing. Normally (in fair weather), a pump with low capacity (dry weather pump) is sufficient to maintain the level in the retention basin at a safe level (Hi-Level). If heavy rainfall causes an increased inflow, the fair weather pump can no longer maintain the level. In such cases, a larger pump is switched on when the HiHi level is exceeded and the dry weather pump is switched off. The large pump then remains in operation until the switch-off point is reached. If the level rises again, the dry weather pump switches back on first.

There is also the possibility of using multiple large pumps in alternating mode. The algorithm for the switching function is then determined by the pump control mode.

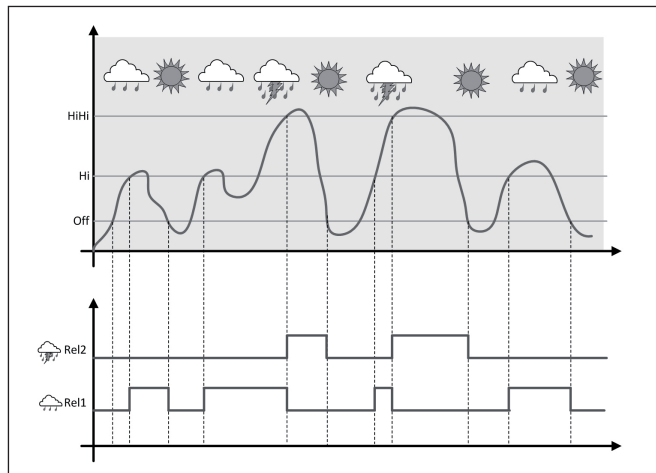

Fig. 16: Example of a pump control with option "Dry weather pump"

**Note:**

If the option "Dry weather pump" is activated, only the mode "Alternating pump operation" will be available, i.e. only one pump at a time is in operation.

Pump control mode

The pump control system offers the possibility to choose between sequenced and alternating pump operation:

- **Sequenced operation:** Depending on the switching points, all pumps are switched on one after the other, i.e. the max. number of pumps that can be switched on corresponds to the number of assigned relays
- **Alternating pump operation:** Independent of the switching point, only one pump at a time is switched on

Option, forced switchover

If the level has not changed over a longer period, the same pump would always remain switched on. Via the parameter "Switchover time", a time can be preset which, after it is elapsed, forces a switchover of the pump. Which pump is switched on depends on the selected pump mode. If all pumps are already switched on, the pump remains switched on. This function can only be set with a PC and DTM.

**Note:**

If the pump is already switched on when the forced switchover is activated, the timer is not started. Only after the pump is switched off and on again will the timer start. If a switch-off delay is set, it will not be taken into account, i.e. the switchover is carried out exactly after the preset time for the forced switchover expires. A preset switch-on delay, however, is taken into account, i.e. the forced switchover to another pump is carried out after the preset time expires. Before the newly selected pump switches on, the preset switch-on delay for this pump must have expired.

Pump monitoring

With a pump control, there is also the possibility of switching on pump monitoring. For this purpose, a feedback signal is required on the respective digital input. The digital inputs are assigned 1:1 to the relays. Digital input 1 acts on relay 1, etc.

If the pump monitoring for a relay was switched on, a timer is started when the relay is switched on (time allowance with parameter "Report time"). If the checkback signal comes from the pump on the respective digital input within the defined report time, the pump relay remains energized, otherwise the relay is immediately switched off and a fault signal outputted. A fault signal and a switching off of the relay is carried out even if the relay is already switched on and the pump checkback signal changes during the running time of the pump. In addition, a switched-off relay of the pump control is looked for and switched on instead of the faulted relay. A Low signal on the digital input is evaluated as a pump error signal.

The fault message is cancelled when the signal on the digital input changes to "Good" or when it is reset via the "OK" key and selection of the menu item "Acknowledge failure". If the fault message is reset via the menu and the pump still signals failure, a fault message

is triggered after the enquiry period. The enquiry period is started as described above when the relay is switched on.

Switch-on behaviour of pump control 2

When the controller is switched on, the relays are at first in a switched-off status. Depending on the actual input signal and the switched-on period of the individual relays, the following relay switching conditions can occur after the start procedure:

- Input signal is higher than the upper switching point -> Relay with the shortest switched-on period is switched on
- Input signal is between lower and upper switching point -> Relay remains switched off
- Input signal is smaller than the lower switching point -> Relay remains switched off

8.3 Pump control 3/4 (sequentially controlled)

Functional principle

Pump control 3/4 is used to control several pumps with the same function alternately and in a fixed sequence. In case of increased pumping requirement, all pumps can also run at the same time, in dependence on the entered switching points. This measure achieves an even utilization of the pumps and increases operational reliability.

All relays with activated pump control are not assigned to a certain switching point but are switched on and off alternately. When a switch-on point is reached, the controller selects the relay that is next in the sequence. When a switch-off point is reached, the relays are switched off in the sequence they were switched on.

Via the digital inputs, possible fault signals of the pumps can also be evaluated. You can find the description of this in the application example " *Pump control 1/2*" under " *Pump monitoring*".

This pump control system offers two different options:

- Pump control 3: The upper switching point determines the switch-off point for the relay, whereas the lower switching point determines the switch-on point
- Pump control 4: The upper switching point determines the switch-on point for the relay, whereas the lower switching point determines the switch-off point

The sequence cannot be changed, the relay with the lowest index is switched on first, then the relay with the next higher index. After the relay with the highest index, the relay with the lowest index follows, for example Rel. 1 -> Rel. 2 -> Rel. 3 -> Rel. 4 -> Rel. 1 -> Rel. 2 ... The sequence applies only to those relays assigned to the pump control.

Example

In a waste water disposal system, a sump should be pumped empty when a certain level is reached. Three pumps are available for this. At 60 % level, pump 1 should run until the level has fallen below 10 %. If the 60 % point is exceeded again, the same task is transferred to pump 2. In the third cycle, pump 3 is activated; after that, pump 1 again. If the level continues to rise despite operation of a pump, an additional pump switched on when the level exceeds the 75 % switch-

ing point. And if the level still rises further due to extreme inflow and exceeds the 90 % limit, pump 3 is also switched on.

Setup

Select in the DTM navigation section the menu items " *Meas. loop - Outputs - Relay*".

- Set mode " *Pump control 4*" for relays 1 ... 3 with option " *Sequenced operation*".
- Enter the switching points for the affected relays as follows:
 - Relay 1 upper switching point = 60.0 %
 - Relay 1 lower switching point = 10.0 %
 - Relay 2 upper switching point = 75.0 %
 - Relay 2 lower switching point = 10.0 %
 - Relay 3 upper switching point = 90.0 %
 - Relay 3 lower switching point = 10.0 %

The function of pump control 4 is shown in detail in the following diagram. The previously described example is used as a basis.

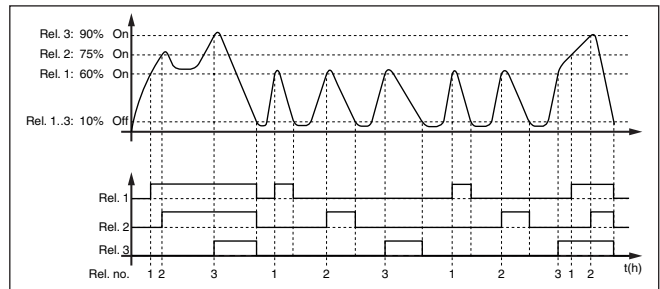

Fig. 17: Example of pump control 4

Display indication

When pump control is activated, the assigned relays and possible pump malfunctions are also displayed in the measured value indication.

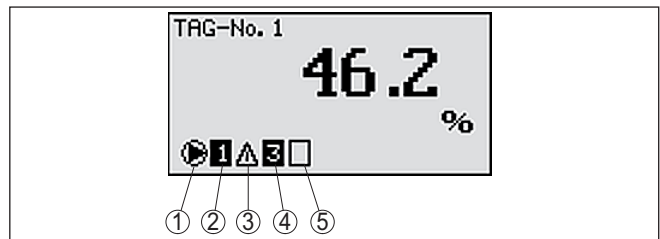

Fig. 18: Display indication of a pump control

- 1 Symbol, activated pump control
- 2 Relay 1 is assigned to the pump control
- 3 Relay 2 is assigned to the pump control and signals failure
- 4 Relay 3 is assigned to the pump control
- 5 Relay 4 is free i.e. not assigned to the pump control

Option Dry weather pump

Pump control 2/4 with dry weather pump is used to protect e.g. rain retention basins with different sized pumps against overflowing.

Normally (in fair weather), a pump with low capacity (dry weather pump) is sufficient to maintain the level in the retention basin at a safe level (Hi-Level). If heavy rainfall causes an increased inflow, the fair weather pump can no longer maintain the level. In such cases, a larger pump is switched on when the HiHi level is exceeded and the dry weather pump is switched off. The large pump then remains in operation until the switch-off point is reached. If the level rises again, the dry weather pump switches back on first.

There is also the possibility of using multiple large pumps in alternating mode. The algorithm for the switching function is then determined by the pump control mode.

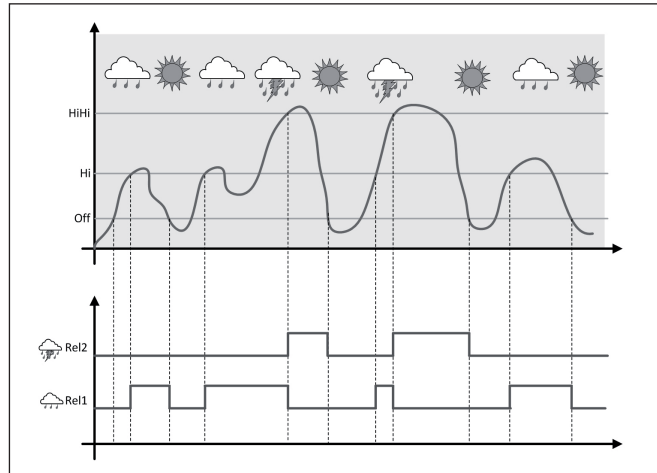

Fig. 19: Example of a pump control with option "Dry weather pump"



Note:

If the option "Dry weather pump" is activated, only the mode "Alternating pump operation" will be available, i.e. only one pump at a time is in operation.

Pump control mode

The pump control system offers the possibility to choose between sequenced and alternating pump operation:

- **Sequenced operation:** Depending on the switching points, all pumps are switched on one after the other, i.e. the max. number of pumps that can be switched on corresponds to the number of assigned relays
- **Alternating pump operation:** Independent of the switching point, only one pump at a time is switched on

Option, forced switchover

If the level does not change over a longer period of time, the same pump would remain switched on. Via the parameter "Changeover time", a time period can be preset, after which a forced changeover of the pump is carried out. This function is described under pump control 1/2.

Pump monitoring

When pump control is activated, pump monitoring can also be switched on. A return signal to the respective digital input is required for this. The function is described under pump control 1/2.

Diagnosis via running time

If all pumps have the same capacity and are used for the same task alternately, the running time should always be roughly the same. The respective operating hours are summed up individually in the controller and can be read out in the menu " *Diagnosis – Switched-on time*". If a large difference between the pumps is determined, the capacity of one of the pumps must have fallen considerably. This information can be consulted for diagnosis and service, e.g. to recognize plugged-up filters or worn out bearings.

Since in this case all pumps operate alternately in the same area, their switch-on and switch-off points must be the same. In addition, the mode " *Alternating pump operation*" must be active.

**Note:**

The index of the last switched-on relay is not saved in case of voltage loss, this means that after the controller is switched back on again, the relay with the lowest index always starts first.

8.4 Tendency recognition

Functional principle

The function of the tendency recognition is to recognize a defined change within a certain time period and transfer this information to a relay output.

Principle of operation

The information for tendency recognition is generated from the measured value change per time unit. The output variable is always the measured value in percent. This function can be configured for rising and falling tendency. The actual measured value is determined and summed with a sampling rate of one second. After the max. reaction time has elapsed, the average value is generated from this sum. The real measured value change results from the newly calculated average value minus the previously calculated average value. If this difference exceeds the defined percentage value, the tendency recognition function responds and the relay deenergises.

**Note:**

Activation and configuration of tendency recognition requires PACTware with the suitable DTM. The respective parameters cannot be set via the integrated display and adjustment unit.

Parameter

- **Measured value change higher:** Measured value change per time unit, at which the tendency recognition should respond
- **Max. reaction time:** Time after which a new average value is calculated and the measured value change is recalculated
- **Hysteresis:** is automatically always 10 % of the value of " *Measured value change larger than*"
- **Reaction in case of failure:** In case of a failure, the relay goes into the defined condition

**Note:**

After a switching on or a fault occurs, two complete cycles must elapse before a measured value difference can be calculated and a tendency output.

Example

The level in a basin is to be monitored for rising tendency. If the rise is higher than 25 % per minute, an additional emptying pump should be switched on. The max. reaction time should be one minute. In case of a fault, the pump should be switched off.

Setup

Select in the DTM navigation section the menu items " *Meas. loop - Outputs - Relay*".

- E.g. set for relay 1 the mode " *Rising tendency*"
- Select under " *Reaction in case of failure*" the option " *Switching condition off*"
- Enter the following values into the parameter fields:
 - Measured value more than 25 %/min.
 - Max. reaction time 1 min.

The function of the tendency recognition is shown in detail in the following diagram. The previously described example is used as a basis.

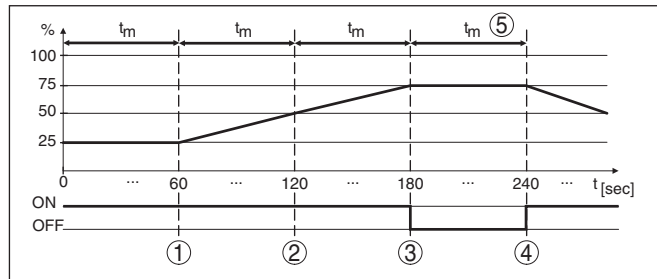

Fig. 20: Example of tendency recognition

- 1 Old average value = 25 %, new average value = 25 %
Difference < 25 % -> Relay ON
- 2 Old average value = 25 %, new average value = 37.5 %
Difference < 25 % -> Relay ON
- 3 Old average value = 37.5 %, new average value = 62.5 %
Difference = 25 % -> Relay OFF
- 4 Old average value = 62.5 %, new average value = 75 %
Difference < 25 % -> Relay ON
- 5 t_m -> max. reaction time

8.5 Flow measurement

Functional principle

For flow measurement in open flumes, a constriction or standard flume must be used. Depending on the flow volume, this constriction generates a certain level of backwater. The flow rate can be determined from the height of this backwater. The flow volume is outputted via an appropriate number of pulses on the relay or current output and can thus be further processed by connected downstream instruments.

There is also the option of summing up the flow volume by means of totalizers, the result is available on the display and as PC/DCS value.

Flume

Every flume generates a different level of backwater depending on its type and version. The specifications of the following flumes are available in the instrument:

- Palmer-Bowlus flume
- Venturi flume, trapezoidal weir, rectangular overflow
- Triangular overflow, V-notch

Setup

The configuration of the flow measurement loop requires PACTware with the suitable DTMs. The example refers to a flow measurement with a radar sensor. The following setup steps must be carried out:

- Selection of the parameter "Flow"
- Carry out adjustment
- Select flume (linearization)
- Set scaling
- Set parameters of pulse outputs
- Parameter adjustment of the totalizer

Parameter - Flow

Select in the DTM window "Parameter" the option "Flow" with the requested unit of measurement.

Adjustment

Min. adjustment: Enter the suitable value for 0 %, i.e. the distance from the sensor to the medium when there is no flow. In the following example this is 1.40 m.

Max. adjustment: Enter the suitable value for 100 %, i.e. the distance from the sensor to the medium when there is maximum flow rate. This is 0.80 m in the following example.

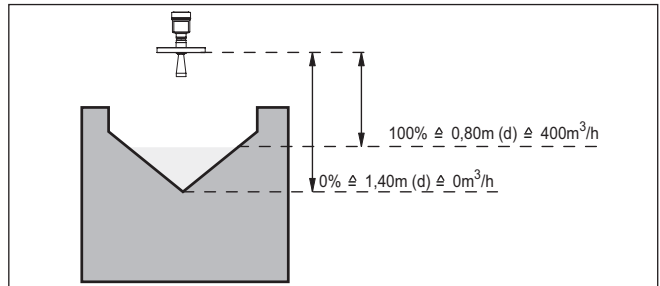

Fig. 21: Adjustment of flow measurement with V-notch

Linearisation curve

Select in the DTM window "Linearization" the option "Flow" and then the flume type used (V-notch in the above example).

Scaling

Select in the DTM window "Scaling" under "Parameter" the option "Flow". Then the allocation of values must be carried out, i.e. a flow volume is assigned to the 0 and 100 % values respectively. In the last

step, select the requested meas. unit. For the above example: 0 % = 0 and 100 % = 400, meas. unit m^3/h .

Outputs

First of all decide if you want to use a relay and/or a current output. In the DTM window " *Outputs* " you can use any of the three outputs as long as these are not yet used for other tasks.

Then select under " *Mode* " (relay) or " *Output characteristics* " (current output) the option " *Flow volume pulse* " or " *Sampling pulse* ". Enter under " *Pulse output all* " the flow volume after which a pulse should be outputted (e.g. 400 m^3 corresponds to one pulse per hour with a flow volume of $400 \text{ m}^3/\text{h}$).

In mode " *Sampling pulse* " an additional pulse is output after a defined time. This means that a timer is started after each pulse, after which another pulse is output. This only applies if a pulse was not already output after the flow volume was exceeded.

Due to sludge at the bottom of the flume, it can happen that the min. level value originally set can no longer be reached. The result is that small flow quantities will be continuously detected despite the "empty" flume. The option " *Min. flow volume suppression* " offers the option of suppressing measured flow volumes below a certain percentage value for flow volume detection.

Totalizer

If flow measurement has been set up, the flow value can also be summed up and displayed as flow volume. The flow volume can be displayed in its own measured value indication in the highest menu level. The following parameters must be adjusted for the totalizers:

- Measuring unit: Selection of the unit the totalizer uses for adding.
- Display format: Selection of the display format (number of decimal positions of the counter)



Information:

The totalizers can be reset in the menu " *Additional adjustments* " - " *Reset* ". As an alternative, the counter can also be reset in the measured value indication by pressing " *OK* " and " *Reset* ".

9 Diagnostics and servicing

9.1 Maintenance

Maintenance

If the device is used properly, no special maintenance is required in normal operation.

Cleaning

The cleaning helps that the type label and markings on the instrument are visible.

Take note of the following:

- Use only cleaning agents which do not corrode the housings, type label and seals
- Use only cleaning methods corresponding to the housing protection rating

9.2 Rectify faults

Reaction when malfunction occurs

The operator of the system is responsible for taking suitable measures to rectify faults.

Causes of malfunction

The device offers maximum reliability. Nevertheless, faults can occur during operation. These may be caused by the following, e.g.:

- Measured value from sensor not correct
- Voltage supply
- Interference in the cables

Fault rectification

The first measures to be taken are to check the input and output signal as well as to evaluate the error messages via the display. The procedure is described below. Further comprehensive diagnostics can be carried out on a PC with PACTware and the suitable DTM. In many cases, the causes can be determined in this way and faults rectified.

Reaction after fault rectification

Depending on the reason for the fault and the measures taken, the steps described in chapter " *Setup*" must be carried out again or must be checked for plausibility and completeness.

24 hour service hotline

Should these measures not be successful, please call in urgent cases the VEGA service hotline under the phone no. **+49 1805 858550**.

The hotline is manned 7 days a week round-the-clock. Since we offer this service worldwide, the support is only available in the English language. The service is free, only standard call charges are incurred.

9.3 Diagnosis, fault messages

Status messages

When the connected sensor is provided with a self-monitoring according to NE 107, the probably occurring status messages are passed on and output on the VEGAMET indication. Requirement is that the HART input of the VEGAMET is activated. You can find further information in the operating instructions manual of the sensor.

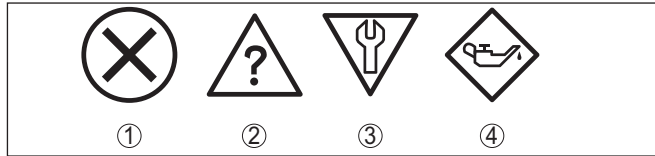

Fig. 22: Pictographs of the status messages

- 1 Failure
- 2 Function check
- 3 Out of specification
- 4 Maintenance required

Fault message

The controller and the connected sensors are permanently monitored during operation and the values entered during parameter adjustment are checked for plausibility. If irregularities occur or in case of incorrect parameter adjustment, a fault signal is triggered. In case of an instrument defect or line break/shortcircuit, a fault signal is also triggered.

The fault indication lights up in case of failure and the current output as well as the relays react according to the configured fault mode. If the fail safe relay was configured, it will deenergize. In addition, one of the following error messages is outputted on the display.

Error code	Cause	Rectification
E003	CRC error (error with self-check)	Carry out a reset Send instrument for repair
E007	Sensor type not compatible	Search for sensor again and allocate under " <i>Measuring point - Input</i> "
E008	Sensor not found	Check connection of the sensor Check HART address of the sensor
E013	Sensor signals error, no valid measured value	Check sensor parameter adjustment Send sensor for repair
E014	Sensor current > 21 mA or short-circuit	Check sensor, e.g. on failure Remove short-circuit
E015	Sensor in boot phase Sensor current < 3.6 mA or line break	Check sensor, e.g. on failure Remove line break Check connection of the sensor
E016	Empty/full adjustment reversed	Carry out a fresh adjustment
E017	Adjustment span too small	Carry out a fresh adjustment and increase the distance between min. and max. adjustment
E021	Scaling span too small	Carry out a fresh scaling, increase the distance between min. and max. scaling.

Error code	Cause	Rectification
E030	Sensor in boot phase Measured value not valid	Check sensor parameter adjustment
E034	EEPROM CRC error	Switch the instrument off and on Carry out a reset Send instrument for repair
E035	ROM CRC error	Switch the instrument off and on Carry out a reset Send instrument for repair
E036	Instrument software not executable (during software update and after failed update)	Wait until software update is finished Carry out another software update
E053	Sensor measuring range is not read correctly	Communication error: Check sensor cable and shielding
E062	Pulse priority too small	Increase under " <i>Output</i> " the entry " <i>Pulse output all</i> " so that max. one pulse per second is output
E110	Relay switching points too close together	Increase the difference between the two relay switching points
E111	Relay switching points interchanged	Change relay switching points for " On/Off "
E115	Several relays are assigned to the pump control which are not set to the same failure mode	All relays which are assigned to the pump control must be set to the same failure mode
E116	Several relays that are not configured with the same mode are assigned to the pump control	All relays which are assigned to the pump control must be set to the same mode
E117	A monitored pump signals failure	Check the faulty pump. For acknowledgement, carry out the reset " <i>Failure relay 1 ... 4</i> " or switch the instrument OFF and ON again

9.4 How to proceed if a repair is necessary

You can find an instrument return form as well as detailed information about the procedure in the download area of our homepage. By doing this you help us carry out the repair quickly and without having to call back for needed information.

In case of repair, proceed as follows:

- Print and fill out one form per instrument
- Clean the instrument and pack it damage-proof
- Attach the completed form and, if need be, also a safety data sheet outside on the packaging
- Ask the agency serving you to get the address for the return shipment. You can find the agency on our homepage.

10 Dismount

10.1 Dismounting steps

Take note of chapters "*Mounting*" and "*Connecting to voltage supply*" and carry out the listed steps in reverse order.

10.2 Disposal

The device is made of recyclable materials. For this reason, it should be disposed of by a specialist recycling company. Observe the applicable national regulations.

11 Certificates and approvals

11.1 Approvals for Ex areas

Approved versions for use in hazardous areas are available or in preparation for the device series.

You can find the relevant documents on our homepage.

11.2 Approvals as overfill protection

Approved versions for use as part of an overfill protection system are available or in preparation for this device series.

The corresponding approvals can be found on our homepage.

11.3 EU conformity

The device fulfils the legal requirements of the applicable EU directives. By affixing the CE marking, we confirm the conformity of the instrument with these directives.

The EU conformity declaration can be found on our homepage.

Electromagnetic compatibility

The instrument is designed for use in an industrial environment.

Nevertheless, electromagnetic interference from electrical conductors and radiated emissions must be taken into account, as is usual with a class A instrument according to EN 61326-1. If the instrument is used in a different environment, its electromagnetic compatibility with other devices must be ensured by suitable measures.

11.4 Environment management system

Protection of the environment is one of our most important duties.

That is why we have introduced an environment management system with the goal of continuously improving company environmental protection. The environment management system is certified according to DIN EN ISO 14001. Please help us fulfil this obligation by observing the environmental instructions in chapters "*Packaging, transport and storage*", "*Disposal*" of these operating instructions.

12 Supplement

12.1 Technical data

Note for approved instruments

The technical data in the respective safety instructions are valid for approved instruments (e.g. with Ex approval). In some cases, these data can differ from the data listed herein.

All approval documents can be downloaded from our homepage.

General data

Series	Instrument for mounting into front panel, switching cabinet or housing
Weight	620 g (1.367 lbs)
Housing materials	Valox 357 XU
Connection terminals	
– Type of terminal	Pluggable spring-loaded terminal with coding
– Max. wire cross-section	2.5 mm ² (AWG 14)

Voltage supply

Operating voltage	
– Nominal voltage AC	24 ... 230 V (-15 %, +10 %) 50/60 Hz
– Nominal voltage DC	24 ... 65 V (-15 %, +10 %)
Max. power consumption	7 VA; 3 W

Sensor input

Number of sensors	1 x 4 ... 20 mA (HART)
Type of input (selectable)	
– Active input	Sensor supply through VEGAMET 391
– Passive input	Sensor has an own voltage supply
Measured value transmission (switchable with RS232/Ethernet interface option)	
– 4 ... 20 mA	analogue for 4 ... 20 mA sensors
– HART protocol	digital for HART sensors
Deviation	
– Accuracy	±20 µA (0.1 % of 20 mA)
Terminal voltage	
– Non-Ex version	28.5 ... 22 V at 4 ... 20 mA
– Ex version	19 ... 14.5 V at 4 ... 20 mA
Current limitation	approx. 26 mA
Internal resistance mode passive	< 250 Ω
Detection line break	≤ 3.6 mA
Detection shortcircuit	≥ 21 mA
Adjustment range 4 ... 20 mA sensor	
– Empty adjustment	2.4 ... 21.6 mA

– Full adjustment	2.4 ... 21.6 mA
– min. adjustment delta	16 μ A
Adjustment range HART sensor	
– Adjustment range	\pm 10 % of sensor measuring range
– min. adjustment delta	0.1 % of sensor measuring range
Connection cable to the sensor	two-wire shielded standard cable

Digital input

Quantity	4 x digital input
Input type	Passive
Switching threshold	
– Low	-3 ... 5 V DC
– High	11 ... 30 V DC
Max. input voltage	30 V DC
Max. input current	30 mA
Max. sampling rate	10 Hz

Relay outputs

Quantity	6 x operating relay
Function	Switching relay for level, fault signal or pulse relay for flow/sampling pulse
Contact	Floating spdt
Contact material	AgSnO ₂ , hard gold-plated
Switching voltage	min. 10 mV DC, max. 250 V AC/60 V DC
Switching current	min. 10 μ A DC, max. 3 A AC, 1 A DC
Breaking capacity ¹⁾	min. 50 mW, max. 500 VA, max. 54 W DC
Min. programmable switching hysteresis	0.1 %
Mode pulse output	
– Pulse length	350 ms

Current output

Quantity	1 x output
Function	Current output for level or flow/sampling pulse
Range	0/4 ... 20 mA, 20 ... 0/4 mA
Resolution	1 μ A
Max. load	500 Ω
Fault signal (switch over)	0; < 3.6; 4; 20; 20.5; 22 mA
Accuracy	
– Standard	\pm 20 μ A (0.1 % of 20 mA)
– with EMC interferences	\pm 80 μ A (0.4 % of 20 mA)

¹⁾ If inductive loads or stronger currents are switched through, the gold plating on the relay contact surface will be permanently damaged. The contact is then no longer suitable for switching low-level signal circuits.

Temperature error relating to 20 mA	0.005 %/K
Mode pulse output	
– Voltage pulse	12 V DC at 20 mA with load 600 Ω
– Pulse length	200 ms

USB interface ²⁾

Quantity	1 x
Plug connection	Mini-B (4-pole)
USB specification	2.0 (Fullspeed)
Max. cable length	5 m (196 in)

Ethernet interface (optional)

Quantity	1 x, cannot be combined with RS232
Data transmission	10/100 MBit
Plug connection	RJ45
Max. cable length	100 m (3937 in)

RS232 interface (optional)

Quantity	1 x, cannot be combined with Ethernet
Plug connection	RJ45 (modem connection cable on 9-pole D-SUB in the scope of delivery)
Max. cable length	15 m (590 in)

Clock (only with interface option)

Accuracy/Deviation	
– typical	20 ppm (correspond to 10.5 min./year)
– Max.	63 ppm (correspond to 33 min./year)
Power reserve of the lithium battery (Li/MnO ₂)	
– typical	10 years at 20 °C
– Min.	4 years

Indicators

Measured value indication	
– Graphic-capable LC display, with lighting	65 x 32 mm, digital and quasianalogue display
– Max. indicating range	-99999 ... 99999
LED displays	
– Status, operating voltage	1 x LED green
– Status, fault signal	1 x LED red
– Status operating relay 1 ... 6	6 x LED yellow

²⁾ Limited temperature range, see ambient conditions

Adjustment

Adjustment elements	4 x keys for menu adjustment
PC adjustment	PACTware with respective DTM

Ambient conditions

Ambient temperature	
– Instrument in general	-20 ... +60 °C (-4 ... +140 °F)
– USB interface	0 ... +60 °C (32 ... +140 °F)
Storage and transport temperature	-40 ... +80 °C (-40 ... +176 °F)
Relative humidity	< 96 %

Electrical protective measures

Protection rating	
– Front	IP65
– Instrument	IP20
Overvoltage category (IEC 61010-1)	
– up to 2000 m (6562 ft) above sea level	II
– up to 5000 m (16404 ft) above sea level	II - Only with connected overvoltage protection
– up to 5000 m (16404 ft) above sea level	I
Protection class	II
Pollution degree	2

Measures for electrical separation

Reliable separation according to VDE 0106 (part 1) between voltage supply, input and digital component

– Reference voltage	250 V
– Voltage resistance of the insulation	3.75 kV

Galvanic separation between relay output and digital part

– Reference voltage	250 V
– Voltage resistance of the insulation	4 kV

Potential separation between Ethernet interface and digital part

– Reference voltage	50 V
– Voltage resistance of the insulation	1 kV

Potential separation between RS232 interface and digital part

– Reference voltage	50 V
– Voltage resistance of the insulation	50 V

Approvals

Instruments with approvals can have different technical specifications depending on the version.

For that reason the associated approval documents of these instruments have to be carefully noted. They are part of the delivery or can be downloaded by entering the serial number of your instrument into the search field under www.vega.com as well as in the general download area.

12.2 Overview applications/functionality

The following charts provide an overview of the standard applications and functions of controllers VEGAMET 391/624/625 and VEGASCAN 693. They also give information about whether the respective function can be activated and adjusted via the integrated indicating and adjustment unit (OP) or via PACTware/DTM. ³⁾

Application/Function	391	624	625	693	OP	DTM
Level measurement	•	•	•	•	•	•
Process pressure measurement	•	•	•	•	•	•
Differential measurement	-	-	•	-	•	•
Interface measurement	-	-	•	-	•	•
Pressurized vessel	-	-	•	-	-	•
Pump control	•	•	•	-	• ⁴⁾	•
Totalizer	•	-	-	-	-	•
Tendency recognition	•	•	•	-	-	•
Flow measurement	•	•	•	-	-	•
Simulation sensor value/%-value/lin-%-value	•	•	•	•	•	•
Simulation scaled values	•	•	•	•	-	•
Live adjustment	•	•	•	•	•	-
Measured value limitation (suppression of negative measured values)	•	•	•	•	-	•
Selection linearisation curve (cylindrical tank, spherical tank)	•	•	•	•	•	•
Creation of individual linearisation curves	•	•	•	•	-	•
Allocate fail safe relay	•	•	•	•	-	•
Modify allocation of outputs	•	•	•	•	-	•
Switch on/Switch off delay relay	•	•	•	-	-	•
Passive input with Ex version	-	-	-	-	-	-
Modify HART address of the connected sensors	•	•	•	•	•	•
Activate/deactivate measurement loop	-	-	-	•	•	•

Instrument version with interface option

Application/Function	391	624	625	693	OP	DTM
Set the time	•	•	•	•	•	•
Assign/modify IP-addr./Subnet mask/Gateway addr.	•	•	•	•	•	•
Assign/modify DNS server addr.	•	•	•	•	-	•
Parameter adjustment of PC/DCS output	•	•	•	•	-	•
VEGA Inventory System settings	•	•	•	•	-	•
Device trend	•	•	•	•	-	•
Configure transmission of measured values via e-mail	•	•	•	•	-	•

³⁾ Operating Panel (integrated display and adjustment unit)

⁴⁾ only with VEGAMET 391

Application/Function	391	624	625	693	OP	DTM
Configure transmission of measured values via SMS	•	•	•	•	-	•

12.3 Dimensions

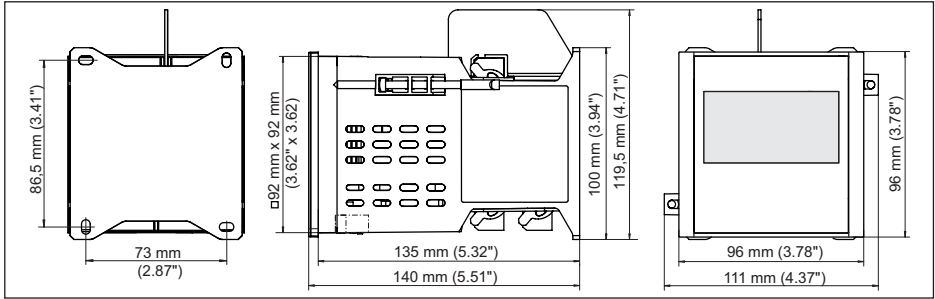

Fig. 23: Dimensions VEGAMET 391

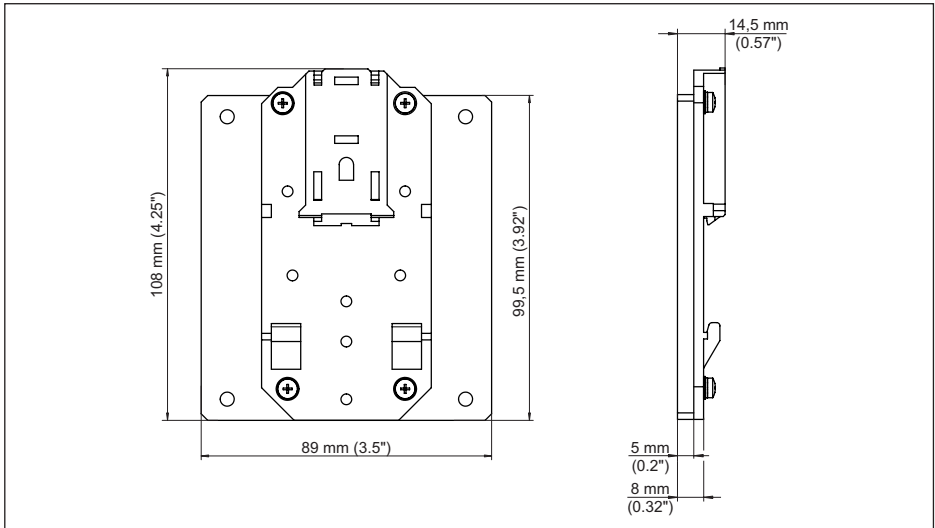

Fig. 24: Dimensions of optional carrier rail adapter

12.4 Industrial property rights

VEGA product lines are global protected by industrial property rights. Further information see www.vega.com.

VEGA Produktfamilien sind weltweit geschützt durch gewerbliche Schutzrechte.

Nähere Informationen unter www.vega.com.

Les lignes de produits VEGA sont globalement protégées par des droits de propriété intellectuelle. Pour plus d'informations, on pourra se référer au site www.vega.com.

VEGA lineas de productos están protegidas por los derechos en el campo de la propiedad industrial. Para mayor información revise la pagina web www.vega.com.

Линии продукции фирмы ВЕГА защищаются по всему миру правами на интеллектуальную собственность. Дальнейшую информацию смотрите на сайте www.vega.com.

VEGA系列产品在全球享有知识产权保护。

进一步信息请参见网站 < www.vega.com。

12.5 Trademark

All the brands as well as trade and company names used are property of their lawful proprietor/originator.

INDEX

A

Access protection 27, 28
 Adjustment 22, 39, 54
 – Max. adjustment 23
 – Min. adjustment 22
 Agitated product surface 23
 Application area 8
 ASCII protocol 40
 Assistant 19

C

Cable
 – Grounding 13
 – Potential equalisation 13
 – Shielding 13
 Carrier rail mounting 11
 Causes of malfunction 53
 Current output 25

D

Damping 23
 Date of manufacture 29
 Date setting 21
 Default setting 27
 Device info 29
 Device-TAG 20
 DHCP 18, 37
 Diagnostics 26
 Display
 – Background lighting 26
 – Brightness 26
 – Language adjustment 26
 Displayed value 25
 Documentation 7
 Driver 37
 Dry run protection 24, 41
 DTM 8, 18, 24, 37, 40
 – DTM Collection 39
 – Full version 40

E

E-mail 37, 40
 Ethernet 37, 40
 Ethernet interface 28

F

Fault 25
 – Fail safe relay 24, 25
 – Fault message 26, 54
 – Rectification 53

Flow measurement 17, 22, 24, 50
 Flume 51
 Front panel mounting 10
 Functional principle 8

G

Gateway 20

H

HART 28
 Horizontal cylindrical tank 23, 41
 Host name 20
 HTML 37
 Hysteresis 42

I

Input
 – 4 ... 20 mA 21
 – Active 13
 – HART 21
 – Passive 13
 Installation possibilities 10
 Integration time 23
 Interface measurement 22
 IP address 20, 37, 40

L

Language adjustment 26
 Level measurement 41
 Linearisation 23
 Linearisation curve 23, 41
 Line break 54
 Lin. percent 25

M

MAC address 29
 Main menu 19
 Meas. loop TAG 24
 Measured value indication 18
 Measured variable 22
 Modbus-TCP 40
 Modem 38
 Multidrop 28
 Multiviewer 40

N

Network 18

O

Online help 29, 40
 Operating instructions 7

Overflow protection 24, 41

P

PACTware 8, 18, 24, 37
Palmer-Bowlus flume 51
Parameter adjustment 18
PIN 27, 28
Potential equalisation 13
Primary Value 21
Pump control 24, 42, 46

Q

QR code 7

R

Rectangular overflow 51
Relay 55
Relay output 24
– Fail safe relay 25, 54
Remote access 28
Repair 55
Reset 27
RS232 38
– Communication protocol 20
– Connection assignment RS232 modem
connection cable 39
– USB - RS232 adapter 38
RS232 interface 28

S

Scaling 23, 25, 41, 54
Screw mounting 11
Secondary Value 21
Sensor address 28
Sensor input
– Active 13
– Passive 13
Serial number 7, 29
Service hotline 53
Setup assistant 19
Short-circuit 54
Simulation 27
Software update 40
Spherical tank 23
Stocktaking 8
Subnet mask 20
Switching window 24

T

Tank calculation 40
Tendency 24
Tendency recognition 49
Time setting 21

Trapezoidal weir 51
Triangular overflow 51
Type label 7

U

USB 37
– USB - RS232 adapter 38

V

VEGA Inventory System 8, 28
VEGA Tools app 7
Venturi flume 51
Visualization 37
VMI 8
V-Notch 51

W

Web server 40

Printing date:

VEGA

All statements concerning scope of delivery, application, practical use and operating conditions of the sensors and processing systems correspond to the information available at the time of printing.

Subject to change without prior notice

© VEGA Grieshaber KG, Schiltach/Germany 2021



36032-EN-210616

VEGA Grieshaber KG
Am Hohenstein 113
77761 Schiltach
Germany

Phone +49 7836 50-0
E-mail: info.de@vega.com
www.vega.com